

ARNO[®]
WERKZEUGE

**Werkzeuge und Wendeschneidplatten
zum Bohren**

*Drilling tools and indexable inserts
for drilling*

Utensili ed inserti di foratura

BOHREN



Übersicht

Program overview
Famiglie prodotti

Innenbearbeitung / Internal machining / Lavorazione interna

SHARK-Cut® Standard

Ø 8 mm – Ø 32 mm

Bohrtiefe / Drill depth / Profondità utile
1,5xD / 2,25xD / 3xD

4

Vollhartmetall-Spiralbohrer

Solid carbide drills

Punte elicoidali in MD integrale

Ø 1 mm – Ø 20 mm

Bohrtiefe / Drill depth / Profondità utile
3xD / 5xD / 8xD / 10 – 20xD

5

SHARK-Cut® Mini

Ø 4 mm – Ø 8 mm

Bohrtiefe / Drill depth / Profondità
utile
2,25xD / 4xD

4

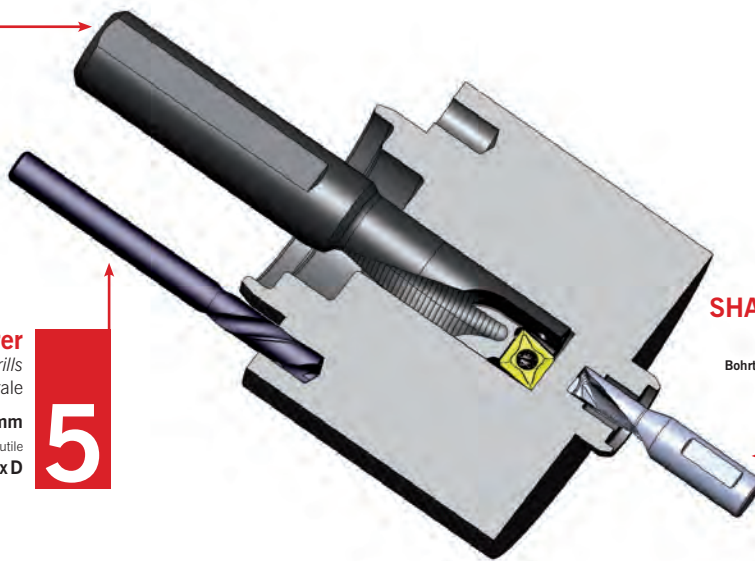

Außenbearbeitung / External machining / Lavorazione esterna

ARNO AKB

Ø 14 mm – Ø 45 mm

Bohrtiefe / Drill depth / Profondità utile
2xD / 3xD

3

SHARK-Cut® Rebore

Ø 12 mm – Ø 50 mm

Bohrtiefe / Drill depth / Profondità utile
2,25xD

4

SHARK-Drill®

Ø 9,5 mm – Ø 114 mm

Bohrtiefe / Drill depth / Profondità utile
1xD – 32xD

1

Vollhartmetall-Spiralbohrer

Solid carbide drills

Punte elicoidali in MD integrale

ohne Innenkühlung / without ic / senza fori int.

Ø 1 mm – Ø 20 mm

Bohrtiefe / Drill depth / Profondità utile
3xD / 5xD / 7xD

5

Vollhartmetall-Spiralbohrer

Solid carbide drills

Punte elicoidali in MD integrale

mit Innenkühlung / with ic / con fori int.

Ø 1 mm – Ø 20 mm

Bohrtiefe / Drill depth / Profondità utile
3xD / 5xD / 8xD / 10 – 20xD

5

SHARK-Drill²

Ø 14 mm – Ø 32 mm

Bohrtiefe / Drill depth / Profondità utile
2xD / 3xD / 5xD / 8xD

2

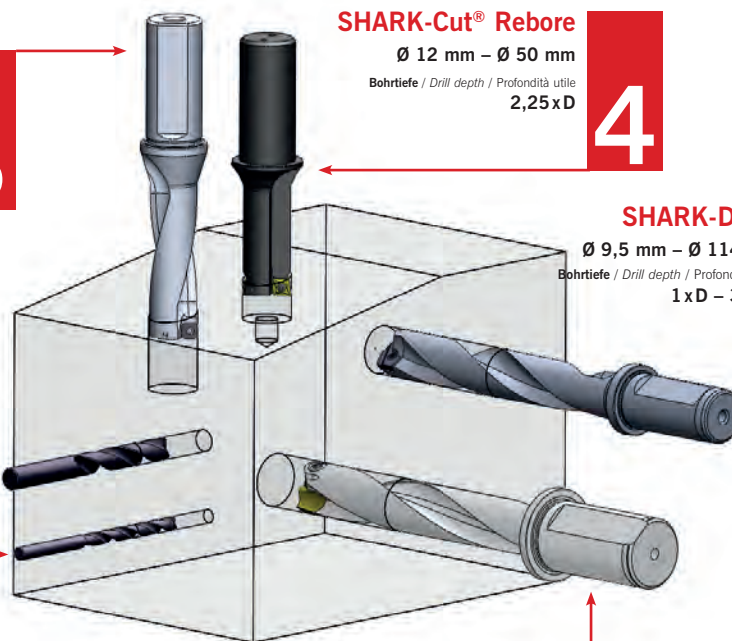

Seite / side / pagina

Über uns	<i>About us</i>	Chi siamo	4 / 12 / 20	0
Service weltweit	<i>Service worldwide</i>	Nel mondo	8 / 16 / 24	
ARNO-Bohrsysteme	<i>Drilling-System</i>	Sistema di tornitura	10 / 18 / 26	

SHARK-Drill®	<i>SHARK-Drill®</i>	SHARK-Drill®		1
• Systemvorstellung	• Introduction	• Caratteristiche del sistema	30 – 33	
• Trägerwerkzeuge	• Drill holder	• Corpo punta	34 – 69	
• Schneideinsätze	• Inserts	• Inserti	70 – 93	

SHARK-Drill²	<i>SHARK-Drill²</i>	SHARK-Drill²		2
• Systemvorstellung	• Introduction	• Caratteristiche del sistema	122 – 125	
• Trägerwerkzeuge	• Drill holder	• Corpo punta	126 – 129	
• Schneideinsätze	• Inserts	• Inserti	130 – 137	

ARNO® AKB	<i>ARNO® AKB</i>	ARNO® AKB		3
• Systemvorstellung	• Introduction	• Caratteristiche del sistema	148 – 151	
• Trägerwerkzeuge	• Drill holder	• Corpo punta	152 – 155	
• Wendeschneidplatten	• Inserts	• Inserti	156 – 159	

SHARK-Cut®	<i>SHARK-Cut®</i>	SHARK-Cut®		4
• Systemvorstellung	• Introduction	• Caratteristiche del sistema	168 – 171	
• SHARK-Cut® Mini	• SHARK-Cut® Mini	• SHARK-Cut® Mini	172	
• SHARK-Cut® Standard	• SHARK-Cut® Standard	• SHARK-Cut® Standard	173 – 175	
• SHARK-Cut® Rebore	• SHARK-Cut® Rebore	• SHARK-Cut® Rebore	176 – 177	
• Wendeschneidplatten	• Inserts	• Inserti	178 – 182	

VHM-Spiralbohrer	<i>Solid carbide drills</i>	Punte in Metallo Duro integrale		5
• Systemvorstellung	• Introduction	• Caratteristiche del sistema	200 – 201	
• Vollhartmetall-Spiralbohrer	• Solid carbide drills	• Punte in metallo duro integrale	202 – 248	

Informationen	<i>Information</i>	Informazioni		i
• Vergleichstabellen	• Comparison tables	• Tavola comparativa dei materiali	258 – 262	
• Verschleiß und Abhilfe	• Wear and its solution	• Usura e soluzioni	263 – 265	
• Anwendungshinweise	• General recommendations	• Suggestimenti tecnici	266 – 280	

Alphanumerischer Index	<i>Alphanumerical index</i>	Indice alfanumerico	282	A
-------------------------------	-----------------------------	----------------------------	-----	---

ARNO®

WERKZEUGE



1941

Emil Arnold (*24.7.1904), Meister bei Bosch, macht sich selbstständig und gründet Emil Arnold Lehrenbau in der Franziskanergasse 7 in Esslingen.

1962

Karl-Heinz Arnold gründet am 1. April Karl-Heinz Arnold Werkzeuge im väterlichen Betrieb. Zweck: Vertrieb von Hartmetallwerkzeugen.

1965

Umfirmierung von „Emil Arnold“ zur „Emil Arnold KG“ Unternehmenszweck: Herstellung von Spezialwerkzeugen und Vorrichtungen für Sondermaschinen sowie Serienfertigung von Spannwerkzeugen.

1966

Umzug der beiden Firmen in das Industriegebiet Ruit Zinsholz, Ostfildern, bei Stuttgart.

1967

Beginn des Vertriebs von Wendschneidplatten aus Hartmetall für die Zerspaltung beim Drehen und beim Fräsen.

1979

Gemeinsam mit der eigenen Fertigung bei Emil Arnold setzt ARNO konsequent auf Marktlücken: Nach einer Entwicklungszeit von nur einem Jahr wird das Mini-Kopiersystem mit einer neuartigen, patentrechtlich geschützten Klemmung entwickelt.

1981

Weitere Entwicklung von eigenen Werkzeugen, die Marktlücken schließen z. B. NC-Stechdrehsystem.

1989

Einstieg in die Schleiftechnik.

Tradition in Präzision.

„Vom lokalen Familienunternehmen zum weltweiten Vertrieb.“

1941 gründet Emil Arnold den „Lehrenbau“ in Esslingen am Neckar. Anfänglich fertigt er hauptsächlich Messvorrichtungen und Prüflehren. Schon damals hat er sich durch die hervorragende Qualität seiner Produkte einen Namen gemacht. Besonders, weil er auf die Kunden eingeht und deren Wünsche präzise erfüllt.

Zusammen mit seinem Sohn Karl-Heinz Arnold steckt er viel Herzblut in die Firma und ist immer offen für neue Entwicklungen. Er hat die Vision, mit seinen Werkzeugen in den Fertigungen aller Länder und Branchen vertreten zu sein. 1962 gründet sein Sohn die Firma Karl-Heinz Arnold GmbH, die sich fortan unter dem Namen ARNO-Werkzeuge vor allem dem Vertrieb von Hartmetallwerkzeugen widmet. Zusammen beschäftigen sich die beiden Firmen konsequent mit Marktlücken, haben immer die Wünsche der Kunden im Auge.

1987 tritt Klaus-Michael Arnold in die Firma ein und wird 1992 Geschäftsführer. Zusammen mit Josef Storf, 2002 zum Geschäftsführer ernannt, werden im Sinne des Firmengründers das Produktsortiment ständig ausgebaut und neue Vertriebswege gesucht. 2004 ist es dann soweit: Im Ausland, bereits über Vertriebspartner etabliert, wird die erste Niederlassung in England gegründet. Bald darauf folgen Italien, Russland und die USA. Durch die stetige Weiterentwicklung des Programms und dank sehr gutem Serviceangebot ist ARNO-Werkzeuge bis heute weltweit anerkannt für seine hochpräzisen Zerspanungswerkzeuge.

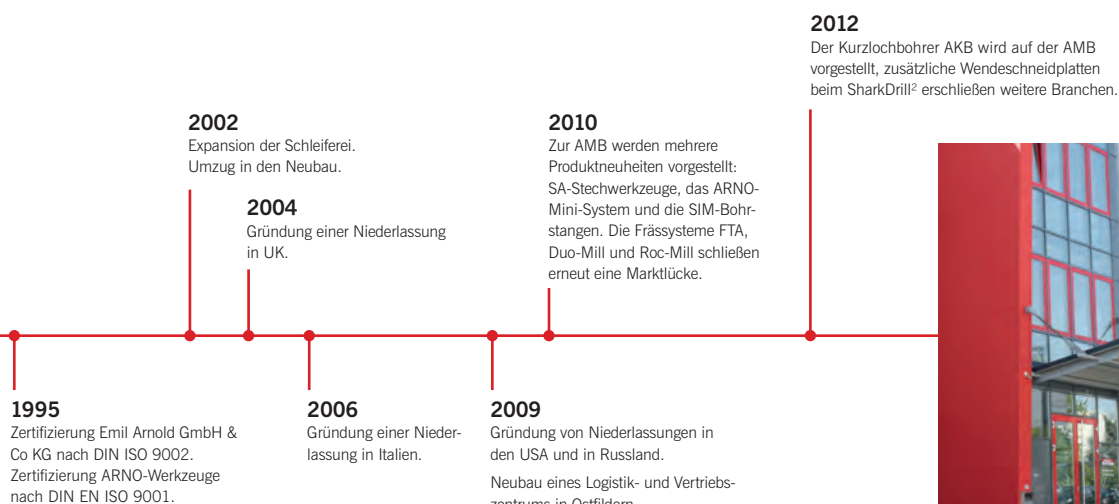

ARNO®

WERKZEUGE

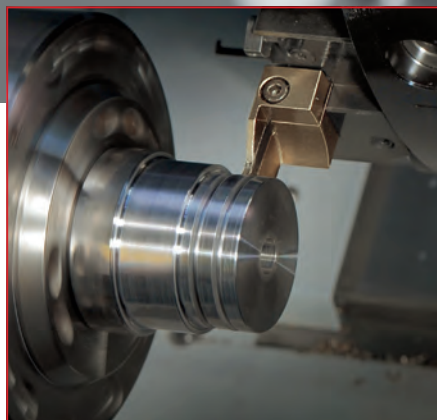

Stechen

Ob Radial- oder Axial-Stechdrehen, Abstechen, Langdrehen oder Innenstechdrehen – Sie finden bei ARNO-Werkzeuge für jede Anwendung das optimale Stechwerkzeug.

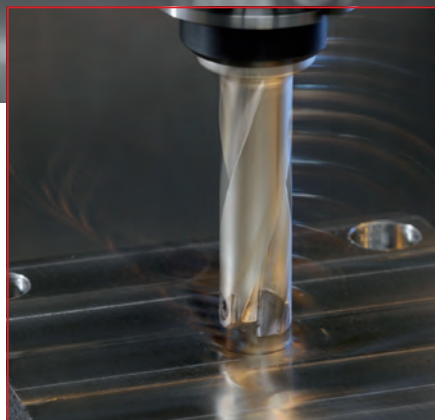

Bohren

Von 1 mm bis 114 mm Durchmesser sind Bohrer mit austauschbaren Schneidplatten und VHM-Spiralbohrer zur Innen- und Außenbearbeitung in unserem Produktportfolio vertreten.



Drehen

ARNO-Werkzeuge bietet zuverlässige Werkzeuge, mit den unterschiedlichsten Wendeschneidplatten, für höchste Ansprüche in der Innen- und Außenbearbeitung sowie zum Gewindedrehen.

Stärke durch Erfahrung, Kompetenz und Entwicklung.

„Für die Zukunft brauchen Sie einen Partner mit Zukunft.“

Durch intensive Zusammenarbeit innerhalb und außerhalb der Firma sind wir in der Lage, individuelle Kundenwünsche mit unserem Know-how zu erfüllen. Dabei entwickeln wir ständig neue Sonderwerkzeuge, um diese dann später auch in unser Standardprogramm aufzunehmen.

Neue Werkstoffe, ebenso wie die Anforderungen nach ständig steigenden Bearbeitungsgeschwindigkeiten, fordern uns, zu forschen und neue Produkte auf den Markt zu bringen. Es gilt, modulare Werkzeugsysteme anzufertigen, die individuell für unterschiedlichste Einsatzbereiche angepasst werden. Unsere leistungsfähige und trotzdem wirtschaftliche Produktpalette beinhaltet vom Bohrsystem über Stechwerkzeuge, Fräsköpfe und einer Vielfalt an Wendeschneidplatten (nicht nur zum Drehen) auch Werkzeugaufnahmen und Werkzeugautomaten.

Neben qualitativ einwandfreien Produkten sind fachliche Beratung und Betreuung für uns selbstverständlich. **Unser kompetentes Team erfüllt Ihre Wünsche und hilft Ihnen mit Service nach Maß auch nach Ihrer Kaufentscheidung.**



Fräsen

Planfräser, Eckfräser, Fasfräser, Fräser mit runden oder eckigen Wendeschneidplatten, Schrufffräser ... Auch für Ihre Anwendung finden Sie einen passenden Fräser.



Werkzeugautomaten

Sichere Werkzeugaufbewahrung, -verfolgung und -entnahme garantiert Ihnen der flexibel konfigurierbare StoreManager.



Werkstückspannung

NC-Schraubstöcke in einfacher oder doppelter Ausführung für perfekt gespannte Werkstücke in der modernen Fertigung.

Service nach Maß.

Individuelle Sonderlösungen

Mit unserem breiten Produktsortiment sind wir bestens für nahezu jede Herausforderung gerüstet. **Sie haben dennoch eine ganz besondere Aufgabe, die besonderes Werkzeug verlangt?** Dann wenden Sie sich an uns, denn ARNO produziert auch kundenorientierte Sonderlösungen – optimal auf Ihre Bedürfnisse zugeschnitten. Das garantiert perfekte Ergebnisse ohne Einschränkungen.

Lieferung über Nacht

Für Sie muss es richtig schnell gehen? Kein Problem, denn wenn Sie die **Bestellung Ihrer Produkte bis 18 Uhr (Freitags bis 16 Uhr) abschließen, steht am nächsten Tag ein Fahrer vor Ihrer Tür.** Dieses Angebot gilt nur für unsere Lagerware, denn um die Qualität unserer individuellen Sonderlösungen zu garantieren, nehmen wir uns für diese auch etwas mehr Zeit.

Alles unter einem Dach

Die **hohe Qualität unserer Produkte** basiert nicht zuletzt darauf, dass **die Konstruktion, die Produktion und der Vertrieb bei ARNO auf einem Gelände stattfinden.** Das ermöglicht uns ausgiebige Testverfahren, schnellere Reaktionszeiten, bessere Kontrolle und – einen günstigeren Preis.

Großes Außendienst-Team

Wir lassen Sie mit unseren Produkten nicht allein. Das ARNO-Außendienst-Team besucht Sie regelmäßig und unterstützt Sie mit umfassendem Produktwissen und Support.

Unsere Anwendungstechniker

Sie haben ein Problem in Ihrer Zerspanung festgestellt oder haben eine Frage, die Sie nur vor Ort klären können? Unsere Anwendungstechniker besuchen Sie in Ihrem Werk und unterstützen Sie bei Technikfragen.

Unsere Bestell-Hotline

Sie haben die Möglichkeit in nahezu allen Ländern der Welt einen unserer ARNO-Mitarbeiter zu erreichen. Profitieren Sie von unserer zuverlässigen und kompetenten Fachberatung am Telefon. Für komplexere Fragen stehen Ihnen persönliche Ansprechpartner zur Verfügung.

Weltweit im Einsatz – Ihr Service direkt vor Ort.

ARNO-Werkzeuge finden Sie überall auf der Welt. Uns ist es wichtig, nicht nur zentral von einem Punkt aus unsere Kunden zu betreuen. Vielmehr möchten wir Ihnen als Kunden einen lokalen Service bieten. Mit Vertriebspartnern und Niederlassungen in vielen Ländern der Welt sind wir für Sie einfach zu erreichen.

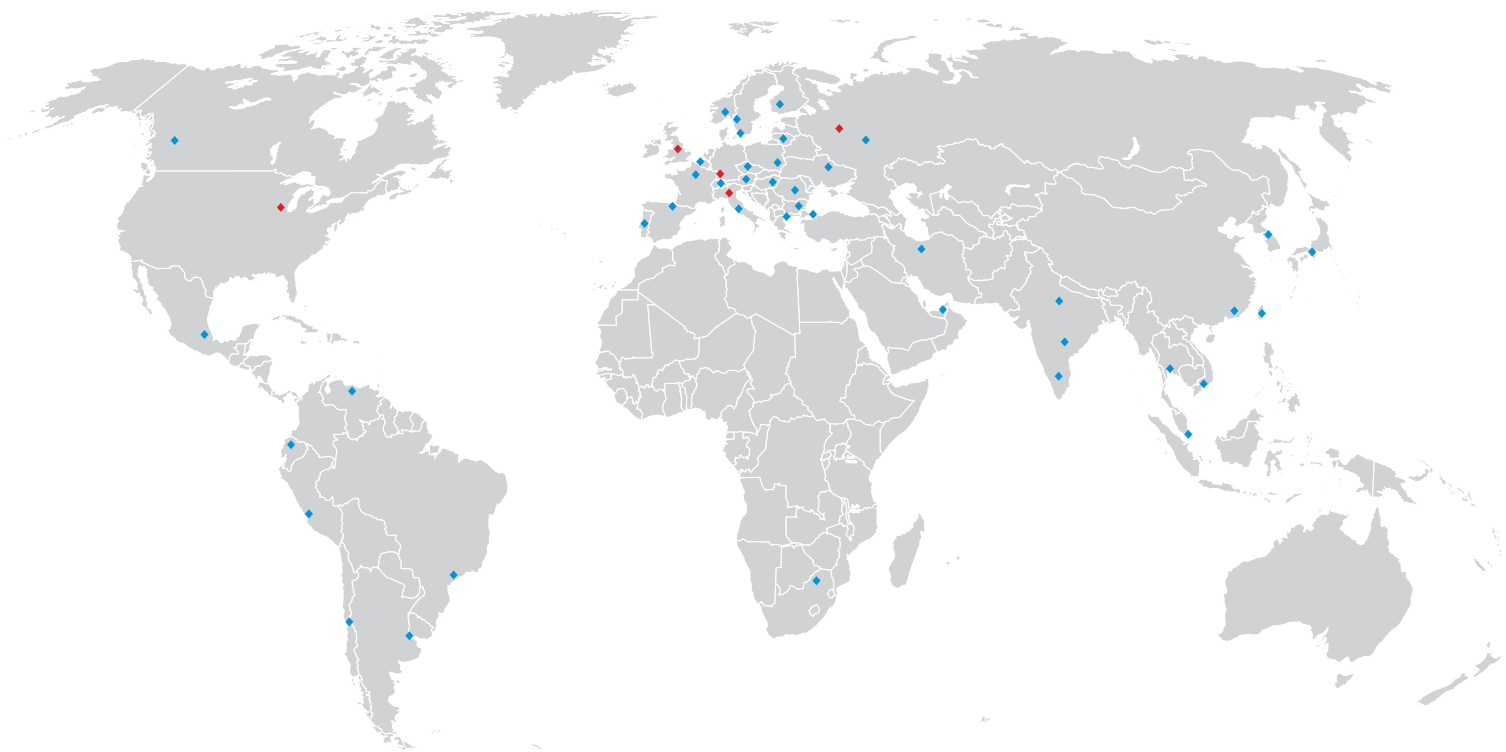

◆ Niederlassungen

◆ Vertriebspartner

Karl-Heinz Arnold GmbH
Karlsbader Str. 4
D-73760 Ostfildern

Tel.: +49 (0) 711/34 802-0
Fax: +49 (0) 711/34 802-130
info@arno.de
www.arno.de

ARNO (UK) Limited | Unit 3, Sugnall Business Centre | Sugnall, Eccleshall | Staffordshire | ST21 6NF
☎ +44 01785 850 072 | 📠 +44 01785 850 076 | sales@arno.de | www.arno-tools.co.uk

ARNO Italia S.r.l | Via J. F. Kennedy 19 | 20871 Vimercate (MB)
☎ +39 039 68 52 101 | 📠 +39 039 60 83 724 | info@arno-italia.it | www.arno-italia.it

ARNO-Werkzeuge USA LLC | 1101 W. Diggins St. | US-60033 Harvard, Illinois
☎ +1 815 943 4426 | 📠 +1 815 943 7156 | info@arnousa.com | www.arnousa.com

ARNO RU Ltd. | Krassnaja Ul. 38 | RU-600015 Vladimir
☎/📠 +7 4922 541125 | 📠 COT +7 4922 541135 | info@arnoru.ru | www.arnoru.ru

ARNO[®]

WERKZEUGE



ab Seite 29

SHARK-Drill

Schneidplattenbohrer im Durchmesserbereich von 9,5 mm bis 114 mm. Vollhartmetall- oder HSS-Einsätze in beschichteter und unbeschichteter Ausführung erhältlich.



ab Seite 121

SHARK-Drill²

Bohrsystem mit austauschbaren Schneideinsätzen in den Durchmessern 14 mm bis 32 mm. Halter in 2xD, 3xD, 5xD und 8xD verfügbar.



ab Seite 147

AKB

Wendeschneidplatten-Bohrer im Durchmesserbereich 14 mm bis 45 mm. Geometrien und Sorten für die Hochleistungszer-spannung von Stahl und rostfreiem Stahl, Gusswerkstoffen und Aluminium. In 2xD und 3xD als Standard erhältlich.

Bohren in Perfektion.

„Präzision, die in die Tiefe geht.“

ARNO-Bohrsysteme zeichnen sich durch höchste Präzision, beste Stabilität, niedrige Zerspanungskräfte, optimale Kühlmittelversorgung sowie perfekte Bohrungsqualitäten aus. Für jedes Bohrsystem sind abgestimmte Wechselplatten hinsichtlich Schneidstoff, Geometrie und Beschichtung verfügbar. So erzielen Sie immer optimale Bearbeitungsergebnisse bei maximaler Leistung und höchster Wirtschaftlichkeit.

Das bewährte SHARK-Drill System sowie das universelle Bohrsystem SHARK-Drill² bestehen aus Trägerwerkzeug und auswechselbarem Hartmetall-Schneideinsatz. Der Kurzlochbohrer AKB bietet dem Anwender noch mehr Möglichkeiten beim Hochleistungsbohren. Höchste Prozesssicherheit auch bei schwierigen Bohrsituationen.

Die Systemvielfalt wird durch Vollhartmetall- und PM-HSS-Spiralbohrer abgerundet. Höchste Präzision beim Bohren nahezu aller gängigen Werkstoffe. Geringe Schnittkräfte und hohe Schnittdaten erleichtern die Bearbeitung ebenso wie die ausgezeichnete Spanabfuhr.

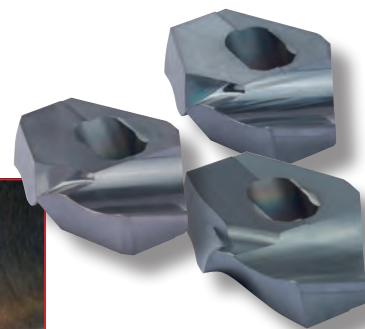

ab Seite 167



ab Seite 199

SHARK-Cut/SHARK-Cut Rebore

Drehen und Bohren mit nur einem Werkzeug.

- Bohren ins Volle mit ebenem Bohrungsgrund
- Drehen von Plankonturen
- Drehen von Innenkonturen
- Drehen von Außenkonturen

Vollhartmetall-Spiralbohrer

Durch ihre spezielle Konstruktion und höchste Genauigkeit geeignet zum Hochgeschwindigkeitsbohren und für genaue Bohrungen.

ARNO®

WERKZEUGE



1941

Emil Arnold (*24.7.1904), decides to become self-employed and establishes "Emil Arnold Lehrenbau" in Franziskanergasse 7 in Esslingen.

1962

On April 1st, Karl-Heinz Arnold establishes "Karl-Heinz Arnold Werkzeuge" in his father's company. Purpose: Sales of carbide cutting tools.

1965

Company re-structuring from "Emil Arnold" to "Emil Arnold KG" and more focus on manufacturing of special tools and jigs for special purpose machines as well as mass production of tool holders.

1966

Both companies moving to the industrial area of "Ruit Zinsholz", Ostfildern, near Stuttgart.

1967

Start of sales for indexable carbide inserts for turning and milling.

1979

Together, in a combined production facility with "Emil Arnold", ARNO starts focusing on market opportunities. After only one year of research and development a mini copy turning system with a patented insert clamping is introduced.

1981

More developments of own tools, for example the NC-grooving and turning system.

1989

Entering into grinding technology.

Tradition in precision.

„Local family business gains global position as a market leader.“

In 1941 Emil Arnold establishes „Lehrenbau“ in Esslingen am Neckar. Initially manufacturing mainly measurement jigs and gauges. Because he always gave his customers exactly what they specified he established himself through the high quality of his products.

Together with his son Karl-Heinz Arnold they put their heart and soul into the company and were always open to new developments. He had a vision to be represented with his cutting tools in all industries all over the world. In 1962 his son forms the company Karl-Heinz Arnold GmbH which under the name ARNO-Werkzeuge began focussing on sales of carbide tools. Both companies were constantly looking for market opportunities with the customers in mind.

In 1987 Klaus-Michael Arnold joined the company and became Managing Director in 1992. In 2002 Josef Storf became joint Managing Director. In the spirit of the company founder, the product portfolio is expanding and the search for new sales channels are constanly being explored. In 2004 ARNO (UK) Ltd becomes the first overseas sister company, followed by sister companies in Italy, Russia and the USA. Due to the constant developments of the product range and the high level of service provided, today ARNO-Werkzeuge is globally renowned for its high quality cutting tools.

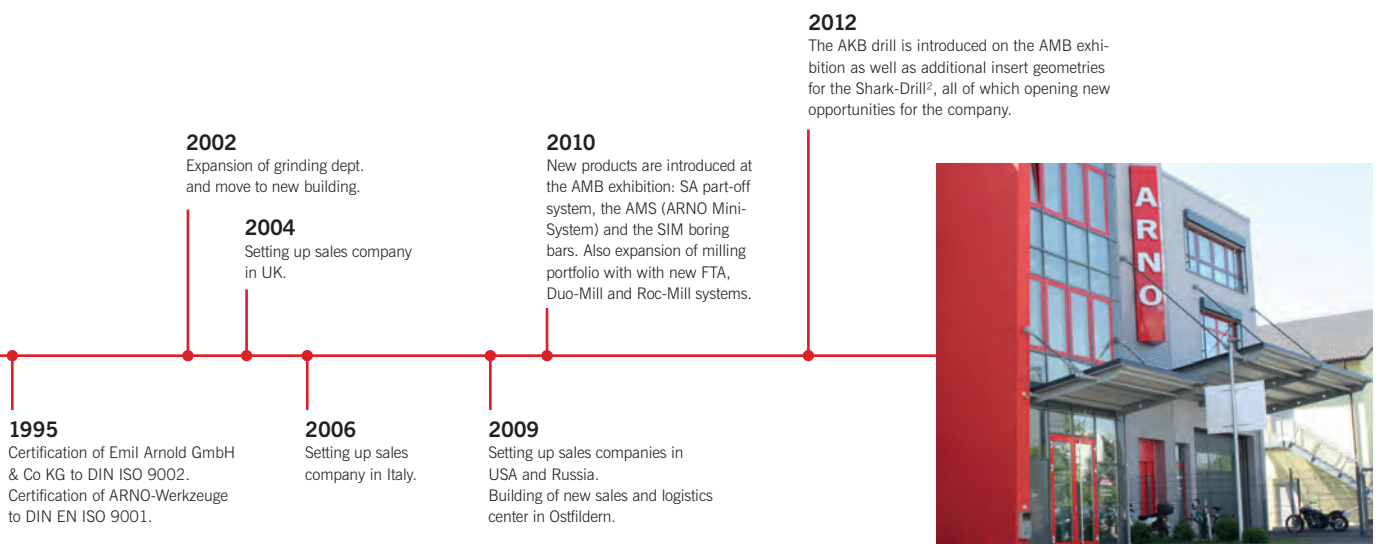

ARNO[®]

WERKZEUGE

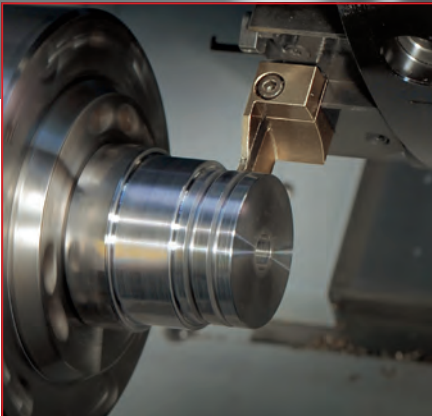
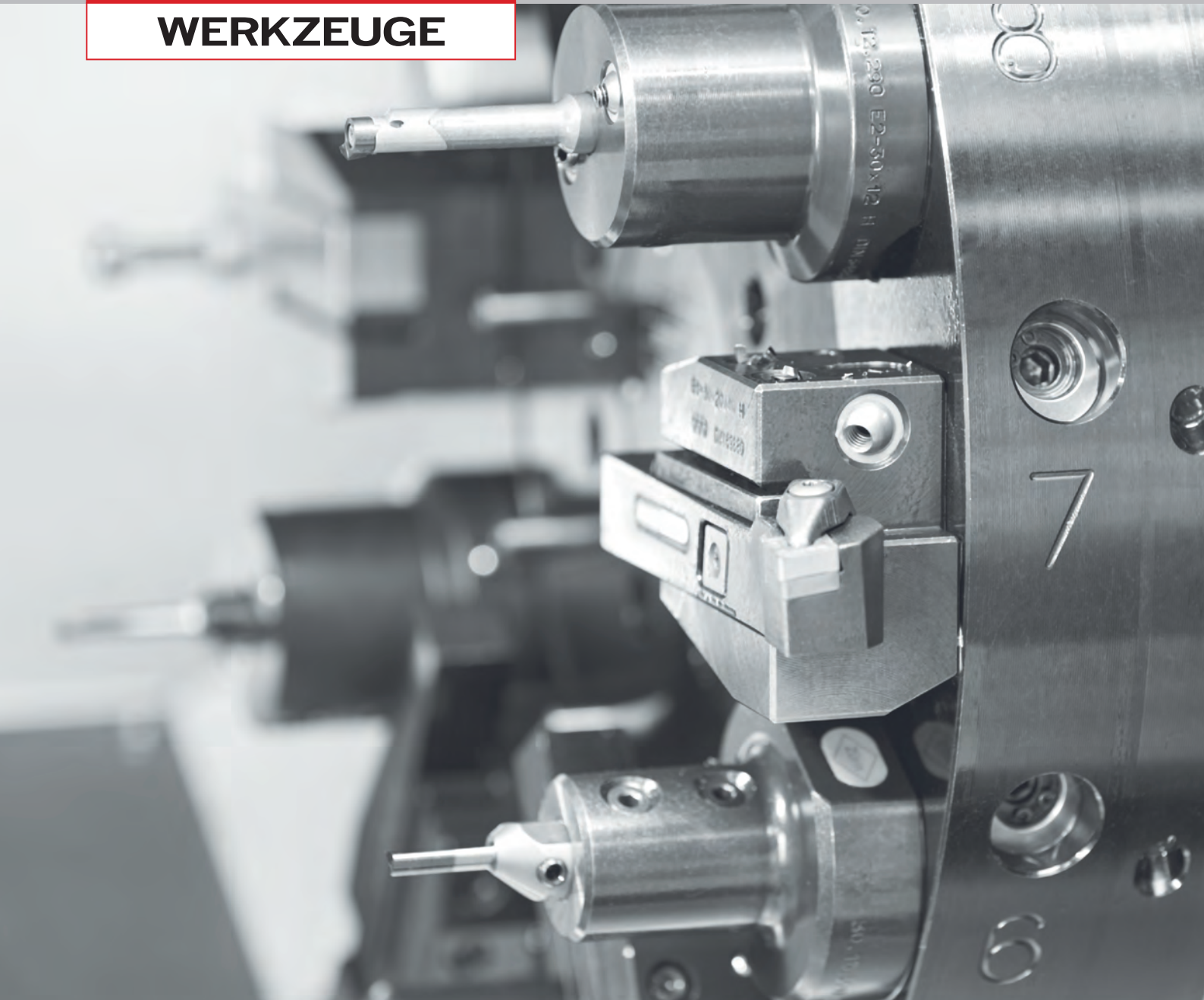

Grooving

Whether it is radial or axial grooving, parting off, groove turning or internal grooving, you will find the ideal tool from ARNO-Werkzeuge.



Drilling

From 1 mm to 114 mm diameter you will find a solid carbide drill or a solution with indexable inserts from our extensive product range.



Turning

ARNO-Werkzeuge offers reliable tools utilizing various inserts for your most demanding internal or external machining applications as well as tools and inserts for threading.

Strength from experience, competence and development.

“For the future you need a partner with future.”

By working closely with partners inside and outside the company, we are very capable of satisfying individual requirements which often lead to special tooling. These tools are consistently improved and might find their way into our standard portfolio of catalog tooling later.

New materials and expectations of constant improvement of machine time, motivate us to research and develop new tooling and cutting tool materials. That means developing modular tooling systems that are modified for each individual application. Our high performance but still affordable solutions include our extensive range of drilling systems, grooving systems, milling cutters and our huge range of indexable inserts (not just for turning) as well as tool holding and vending solutions.

Our technical support and advice follow any of our high quality tools. **Our highly competent team will support you with service even after you have made your decision to purchase.**



Milling

Face-mills, square shoulder-mills, chamfer-mills, milling cutters with round inserts, roughing cutters and solid carbide cutters. We have the right cutter for your application.



Tool Vending

Secure storage, monitoring and usage reporting guaranteed with our highly flexible StoreManager solution.



Work Holding Equipment

NC-machine vice in various executions of number of jaws and widths ensure maximum component clamping for the modern manufacturing.

ARNO[®]

WERKZEUGE

0

Service to Size.

Individual solutions

Despite our wide range of standard tools which will cover a majority of applications, sometimes you may just need a solution for a specific request. ARNO can offer you a special tool which suits your application exactly. A perfect solution without any compromises.

Overnight delivery

When urgency is required ARNO is there to help. Place your order for standard tools by 3:30 PM Central Time and our tools could be on your machine the next day. For special solutions we need a little longer but then you will also be getting a high quality tool just for your application.

Everything under one roof

The high quality of our products is a result of having R&D, manufacturing and sales at one location. This also gives us the opportunity for testing, offering faster response time, better control and better prices.

Experienced external sales team

You are never left alone with an ARNO product. Our experienced external ARNO sales team is always available for service and support.

Our application engineers

When you have a problem with an application our application engineers will be available to advise you on technical issues.

Ordering hotline

Wherever you may be in the world you will be able to contact an ARNO representative. Take advantage of our competence, we look forward to being of service.

Globally available – Service where you need it.

ARNO-Werkzeuge is represented world wide, it is important to us that we can service you where you need it. Our distributors and sister companies are always local and easy to contact.

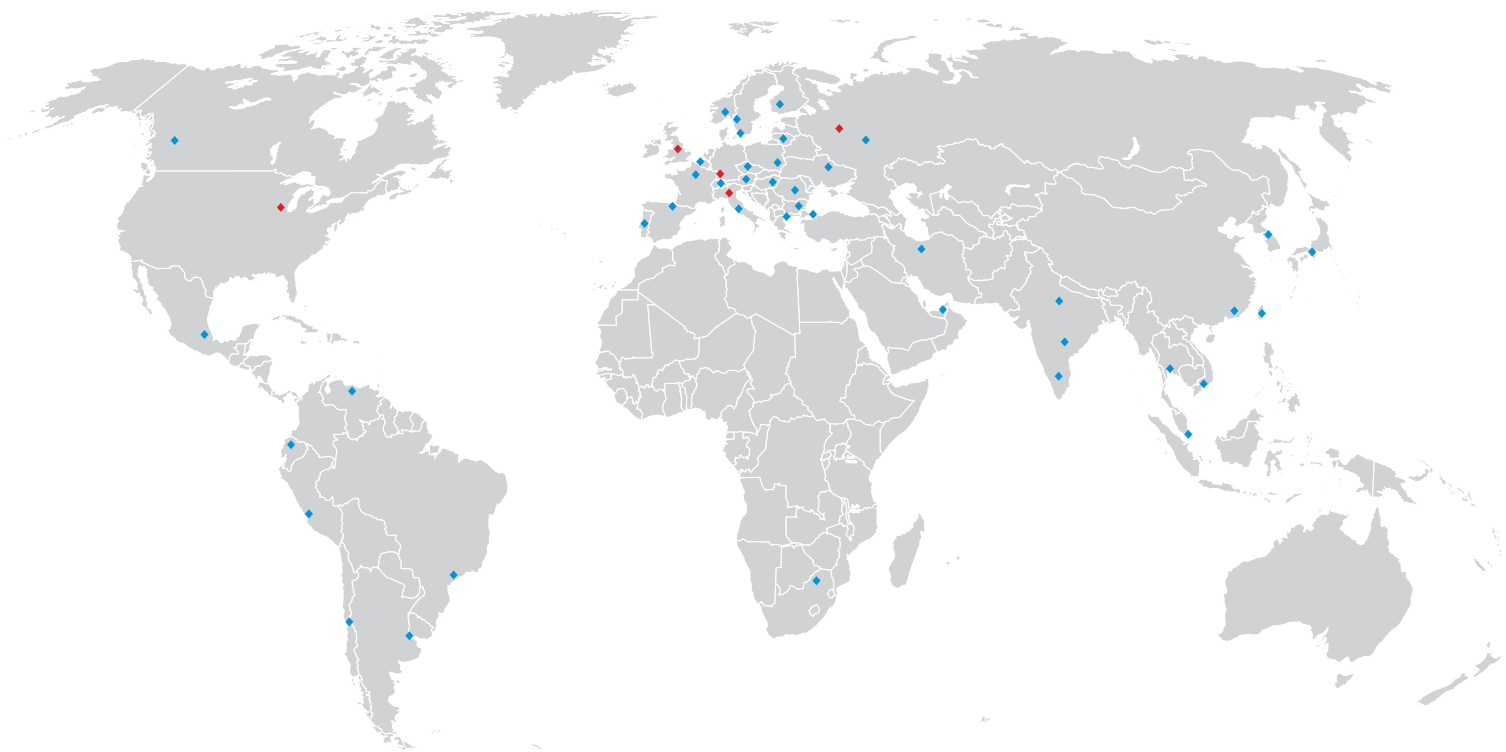

◆ ARNO location ◆ Distributor

Karl-Heinz Arnold GmbH
Karlsbader Str. 4
D-73760 Ostfildern

Tel.: +49 (0) 711/34 802-0
Fax: +49 (0) 711/34 802-130
info@arno.de
www.arno.de

ARNO (UK) Limited | Unit 3, Sugnall Business Centre | Sugnall, Eccleshall | Staffordshire | ST21 6NF
☎ +44 01785 850 072 | 📠 +44 01785 850 076 | sales@arno.de | www.arno-tools.co.uk

ARNO Italia S.r.l | Via J. F. Kennedy 19 | 20871 Vimercate (MB)
☎ +39 039 68 52 101 | 📠 +39 039 60 83 724 | info@arno-italia.it | www.arno-italia.it

ARNO-Werkzeuge USA LLC | 1101 W. Diggins St. | US-60033 Harvard, Illinois
☎ +1 815 943 4426 | 📠 +1 815 943 7156 | info@arnousa.com | www.arnousa.com

ARNO RU Ltd. | Krassnaja Ul. 38 | RU-600015 Vladimir
☎/📠 +7 4922 541125 | 📞 +7 4922 541135 | info@arnoru.ru | www.arnoru.ru



Page 29

SHARK-Drill

Spade drill with a diameter range of 9.5 mm to 114 mm. Inserts available as carbide or HSS both coated and uncoated.



Page 121

SHARK-Drill²

Drilling system with replaceable inserts in diameter range from 14 mm to 32 mm, holders available for drill depth 2xD, 3xD, 5xD and 8xD.



Page 147

AKB

Indexable insert drill with diameter range from 14 mm to 45 mm. Insert geometries for high performance drilling of steel, cast iron and aluminium. Holders are available for drill depth 2xD and 3xD.

Perfection in drilling

“In depth precision.”

The ARNO drilling systems provides excellent accuracy, high stability, low power consumption and optimum coolant supply to the cutting edge ensuring perfect hole making. For every drilling system we offer dedicated indexable inserts in a variety of materials, geometries and coatings. Therefore you will always obtain maximum productivity and performance using an ARNO drill.

The highly popular SHARK-Drill system as well as the SHARK-Drill² system consists of a drill holder and replaceable drilling inserts. The short hole drill – AKB – offers even more performance potential, high productivity also in tough conditions.

Completing the drilling range is an extensive range of solid carbide and powder metal drills for precision drilling of nearly all materials. With low cutting forces, high cutting data potential and excellent swarf control the ARNO drills offer great performance.

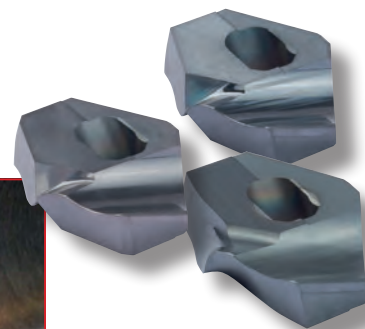

Page 167



Page 199

SHARK-Cut/SHARK-Cut Rebores

Turning and boring with only 1 tool!

- Drilling with flat bottom face
- Facing operations
- Turning of internal profiles
- Turning of external profiles

Solid carbide drills

Suitable for high speed and accurate drilling operations by special design and high quality.

ARNO®

WERKZEUGE



1962

Karl-Heinz Arnold fonda il primo aprile la Karl-Heinz Arnold Werkzeuge. Obiettivo: commercio di utensili in metallo duro.

1965

La Emil Arnold diventa Emil Arnolds KG. Obiettivo: produzione di utensili speciali e dispositivi per macchine speciali oltre che la produzion in serie di utensili di serraggio.

1979

La Emil Arnold dopo uno sviluppo durato un anno mette sul mercato il nuovo sistema di copiatura mini con un nuovo sistema di bloccaggio brevettato.

1941

Emil Arnold, responsabile alla Bosch si rende indipendente e fonda la Emil Arnold ad Esslingen in via Franziskaner 7.

1966

Trasferimento di entrambe le aziende nella zona industriale di Ostfildern vicino a Stoccarda.

1967

Inizio della vendita di inserti in metallo duro per tornitura e fresatura.

1981

Ulteriore sviluppo di propri utensili sul mercato per es. il sistema di scanalatura NC.

1989

Sviluppo della tecnica di affilatura.

Tradizione e precisione.

“Da un’impresa familiare a impresa a livello mondiale.”

1941 Emil Arnold fonda l'azienda ad Esslingen am Neckar. All'inizio produce principalmente strumenti di controllo e misurazione. Si costruisce un nome grazie alla qualità dei prodotti e realizza in pieno le richieste dei clienti.

Insieme al figlio Karl-Heinz Arnold è sempre pronto a nuovi sviluppi. Ha l'obiettivo di vendere i suoi utensili in tutti i Paesi e in tutti i rami dell'industria. Nel 1962 suo figlio fonda la Karl-Heinz Arnold GmbH che successivamente col nome di ARNO-Werkzeuge si dedicherà al commercio di tutti gli utensili in metallo duro.

1987 Klaus-Michael Arnold entra nell'azienda e dal 1992 ne è a capo. Insieme a Josef Storf, nominato amministratore nel 2002, crea nuovi sviluppi e nuovi prodotti. Nel 2004 viene fondata la prima filiale in Inghilterra. Subito dopo seguono l'Italia, gli USA e la Russia. Grazie ai servizi e al programma offerti, oggi ARNO-Werkzeuge è presente in tutti il mondo.

2002

Espansione dell'affilatura.
Trasferimento nella nuova sede.

2004

Viene fondata la filiale nel Regno Unito.

2006

Viene fondata la filiale in Italia.

2009

Vengono fondate filiali in USA e Russia. Costruzione di un nuovo centro logistico a Ostfildern.

2010

Alla AMB vengono presentati nuovi prodotti: sistema di scanatura SA, ARNO Mini-Sytem, SIM, il sistema di fresatura FTA, Duo-Mill e Roc-Mill.

2012

Viene presentata sul mercato la punta AKB e nuovi inserti Shark-Drill² allargano la gamma.



1995

Certificazione di Emil Arnold GmbH & Co KG secondo DIN ISO 9002. Certificazione ARNO-Werkzeuge secondo DIN EN ISO 9001.

ARNO®

WERKZEUGE

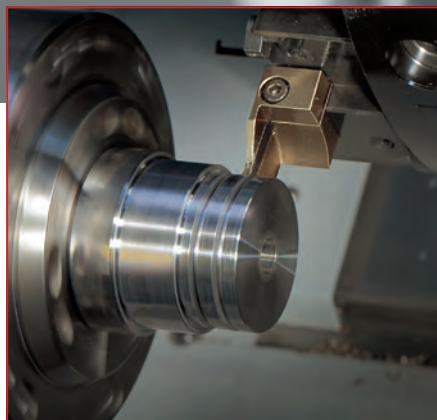
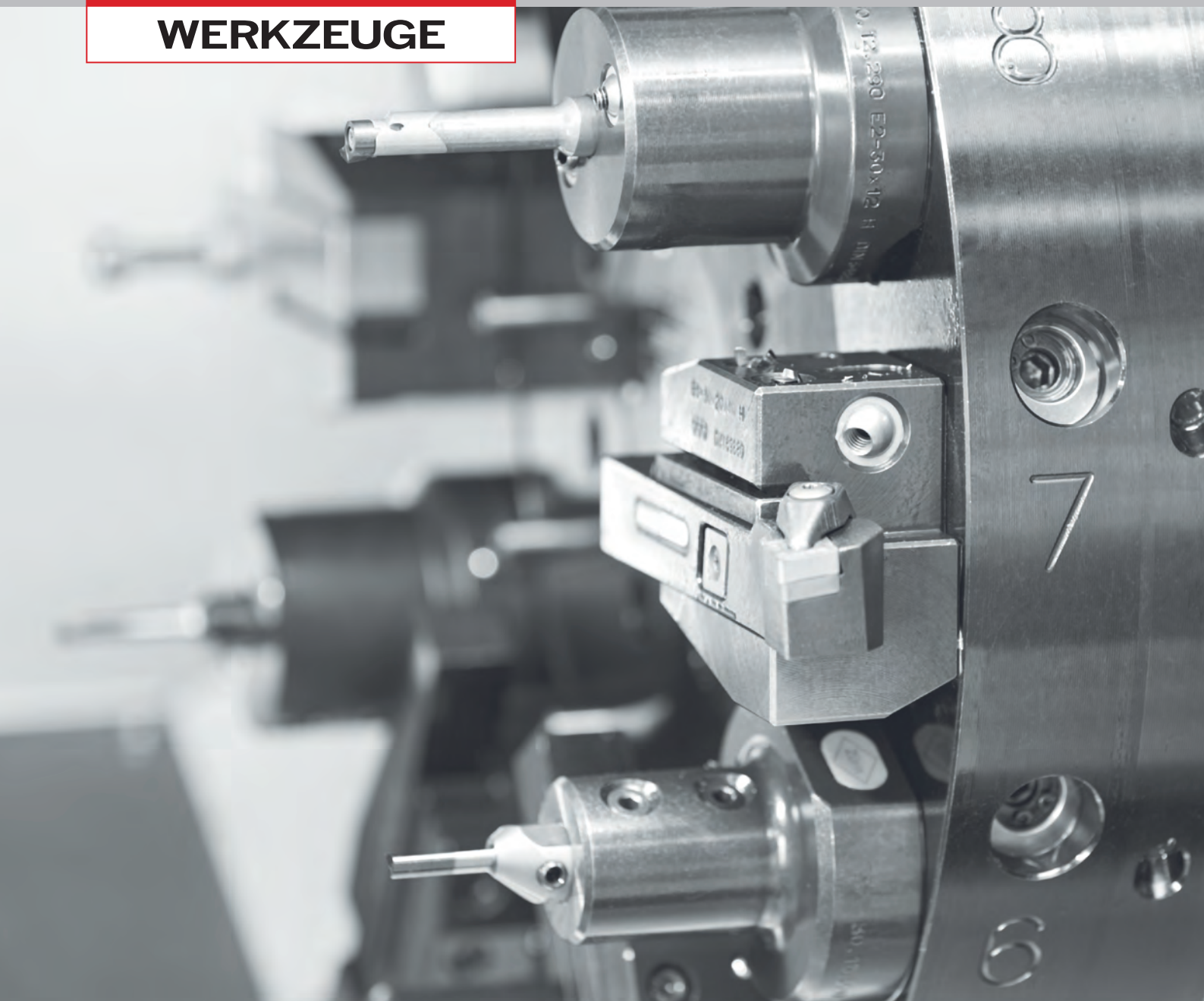

Scanalatura

Con ARNO-Werkzeuge troverete il giusto utensile per ogni tipo di scanalatura: radiale, assiale, interna.



Foratura

Nella nostra gamma prodotti troverete punte ad inserti e punte in metallo duro integrale con diametri a 1 mm a 114 mm per lavorazione interna ed esterna.



Tornitura

ARNO-Werkzeuge offre utensili affidabili con diversi inserti per le migliori prestazioni di lavorazione interna od esterna.

Forza grazie all'esperienza, competenza e sviluppo.

“Per il futuro avete bisogno di un partner con un futuro.”

Grazie all'intensiva collaborazione dentro e fuori dall'azienda siamo in grado di esaudire ogni richiesta del cliente. Per questo sviluppiamo sempre nuovi utensili speciali per poi inserirli nel programma standard.

Nuovi materiali e nuove condizioni di lavorazione ci spingono a sviluppare nuovi prodotti da lanciare sul mercato ad es. utensili modulari che possono essere adattati alle singole esigenze. La nostra gamma di prodotti spazia dalla foratura, alla scanalatura e fresatura, dagli inserti ai distributori di utensili e ai sistemi di bloccaggio.

Oltre ai prodotti di qualità offriamo anche competenza e consulenza. Il nostro team esaudirà le vostre richieste e vi guiderà nella scelta.



Fresatura

Fresatura piana, circolare, sgrassatura anche per queste applicazioni abbiamo l'utensili giusto.



Distributori di utensili

Lo StoreManager garantisce sicurezza e flessibilità.



Bloccaggio utensili

Morse NC semplici o doppie per un bloccaggio ottimale del pezzo.

ARNO[®]

WERKZEUGE

0

Servizio di qualità.

Soluzioni speciali individuali

Con la nostra vasta gamma di prodotti siamo attrezzati per ogni richiesta. Avete bisogno di un utensile particolare per una lavorazione particolare? Rivolgetevi a noi e vi forniremo un prodotto studiato su misura per voi. Risultati perfetti senza limiti!

Consegna in 24 ore

Avete fretta? Nessun problema, poiché se riceviamo i vostri ordini entro le 15,30 voi riceverete la merce il giorno dopo. Questo vale solo per articoli Standard poiché per le soluzioni speciali abbiamo bisogno di più tempo per controllare la qualità del prodotto.

Tutto sotto lo stesso tetto

L'elevata qualità dei nostri prodotti è garantita dal fatto che la progettazione, la produzione e la vendita avvengono in un unico posto. Ciò permette tempistiche veloci, miglior controllo prezzo favorevole.

Un grande team

Non vi lasciamo soli. Il nostro team vi visiterà regolarmente e vi supporterà nella scelta del prodotto più adatto a voi.

I nostri tecnici

Avete una domanda o problemi di lavorazione? I nostri tecnici vi visiteranno e risponderanno ad ogni vostro quesito.

Ordini Hot Line

Avete la possibilità di raggiungere un collaboratore ARNO in tutto il mondo. Approfittate del nostro hel desk telefonico. Tecnici professionali sono a vostra completa disposizione.

Utilizzati nel mondo, assistenza sul posto.

Potete trovare gli utensili ARNO in tutto il mondo. Per noi è importante offrire un servizio localizzato e grazie alle filiali e i vari partner commerciali siamo in grado di raggiungervi in tutto il mondo.

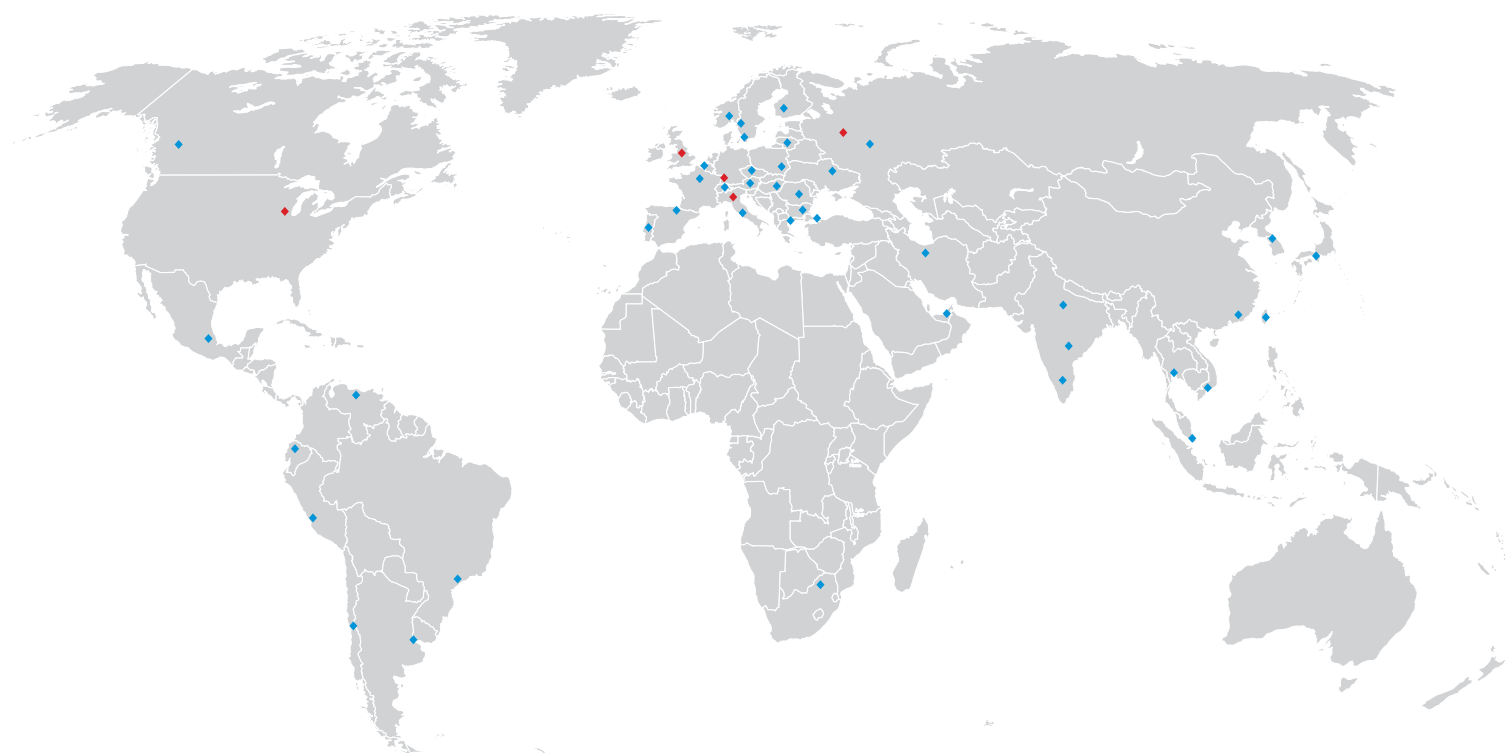

◆ Filiali

◆ Partner commerciali

Karl-Heinz Arnold GmbH
Karlsbader Str. 4
D-73760 Ostfildern

Tel.: +49 (0) 711/34 802-0
Fax: +49 (0) 711/34 802-130
info@arno.de
www.arno.de

ARNO (UK) Limited | Unit 3, Sugnall Business Centre | Sugnall, Eccleshall | Staffordshire | ST21 6NF
☎ +44 01785 850 072 | 📠 +44 01785 850 076 | sales@arno.de | www.arno-tools.co.uk

ARNO Italia S.r.l | Via J.F. Kennedy 19 | 20871 Vimercate (MB)
☎ +39 039 68 52 101 | 📠 +39 039 60 83 724 | info@arno-italia.it | www.arno-italia.it

ARNO-Werkzeuge USA LLC | 1101 W. Diggins St. | US-60033 Harvard, Illinois
☎ +1 815 943 4426 | 📠 +1 815 943 7156 | info@arnousa.com | www.arnousa.com

ARNO RU Ltd. | Krassnaja Ul. 38 | RU-600015 Vladimir
☎/📠 +7 4922 541125 | 📞 COT +7 4922 541135 | info@arnoru.ru | www.arnoru.ru

ARNO[®]

WERKZEUGE



da pagina 29

SHARK-Drill

Punta ad inserti con una gamma di diametri da 9,5 mm a 14 mm. Inserti in metallo duro integrale o in HSS disponibili rivestiti o non rivestiti.



da pagina 121

SHARK-Drill²

Sistema di foratura con inserti intercambiabili in una gamma di diametri da 14 mm a 32 mm. Corpi disponibili 2xD, 3xD, 5xD e 8xD



da pagina 147

AKB

Punta ad inserti con una gamma di diametri da 14 mm a 45 mm. Geometrie e qualità per lavorazioni ad elevate prestazioni di acciaio, ghisa e alluminio. Corpi disponibili 2xD e 3xD

Forare con perfezione.

“Precisione elevata.”

Il sistema di foratura ARNO offre precisione, stabilità, consumi ridotti e lubrificazione ottimale ai bordi taglienti, assicurando la perfetta riuscita del foro. Per ogni sistema di foratura offriamo inserti dedicati con una vasta gamma di materiali, geometrie e rivestimenti. Grazie alle punte ARNO otterrete la massima produttività e la miglior performance.

Il famoso sistema di foratura SHARK-Drill ARNO e il sistema SHARK-Drill² consiste di un corpo e inserti intercambiabili. La punta corta AKB offre un potenziale ancora maggiore anche in condizioni di lavoro più estreme.

Il sistema è completato da punte in metallo duro integrale e in HSS. La più elevata precisione di foratura per ogni materiale. Forze di taglio minime e dati di lavoro elevati offrono la migliore evacuazione del truciolo e le migliori performance.

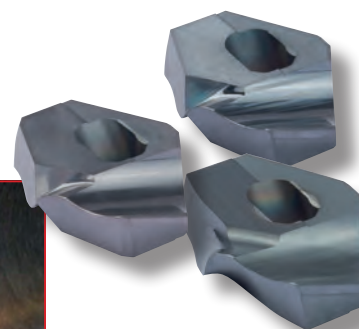

da pagina 167



da pagina 199

SHARK-Cut/SHARK-Cut Rebore

Foratura e barenatura con un unico utensile!

- Foratura con fondo piano
- Sfacciatura
- Tornitura interna con ap ad inserto pieno
- Tornitura esterna

Punte in metallo duro integrale

Grazie alla costruzione accurata e all'elevata precisione sono adatte per la lavorazione ad alta velocità.

Symbol-Navigator

Symbol navigator
Descrizione Simboli

Schneidenzahl / Number of flutes / Numero di taglienti



Schaftform / Shank / Gambo



Anwendung / Application / Applicazione



Bereich / Zone / Zona



Winkel / Angle / Angolo



Innenkühlung / Through tool coolant / Adduzione interna del refrigerante



Beschichtung / Coating / Rivestimento



Toleranz / Tolerance / Tolleranza



Ø-Bereich / Diameter range / Gamma Diametri



Schneidstoff / Cutting material / Materiale utensile



Werkstoff / Material / Materiale da lavorare



Sonstige / Other / Altro



SHARK-Drill®

- Systemvorstellung
- Bezeichnungssystem
- Werkzeugauswahl
- Trägerwerkzeuge
- Schneideinsätze
 - Sortenbeschreibung
 - Geometriebeschreibung
- Ersatzteile
- Schnittwerte
- Anwendungshinweise
- Sonderwerkzeuge

SHARK-Drill®

- *System introduction*
- *Designation system*
- *Tool shank options*
- *Drill holder*
- *Inserts*
 - *Grade description*
 - *Geometry description*
- *Spare parts*
- *Cutting data*
- *Application reference*
- *Special tooling*

SHARK-Drill®

- Caratteristiche del sistema
- Sistema di numerazione
- Tipologie di attacco utensile
- Corpo punta
- Inserti
 - Descrizione delle Qualità
 - Descrizione delle Geometrie
- Ricambi
- Parametri di taglio
- Suggerimenti tecnici
- Utensili speciali

30 – 31
32
33
34 – 69
70 – 93
73 – 74
72
94 – 95
96 – 107
108 – 119
120

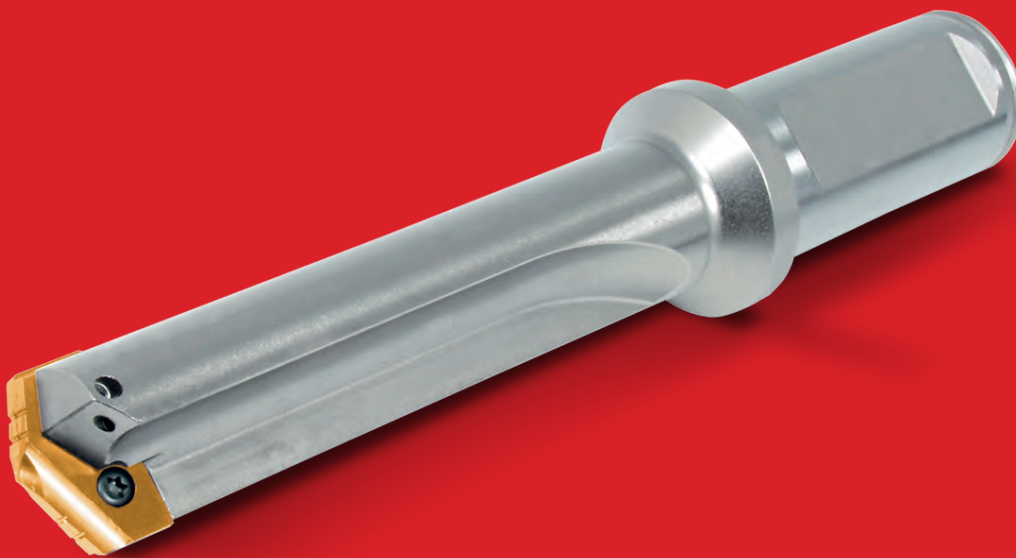

ARNO Schneidplattenbohrer SHARK-Drill®

ARNO Flanged holders SHARK-Drill®

ARNO Corpo punta SHARK-Drill®

1 Alle Halter mit innerer Kühlmittelzuführung

All holders with through tool coolant supply

Passaggio interno del refrigerante su tutti i corpi

Vernickelte Oberfläche – „Rostet nicht“. Glatte Spankammern für bessere Spanausbringung.

Nickel plated surface – “no rust” smooth swarf chambers for better swarf evacuation.

Corpi con rivestimenti Nickel – resistenza alla ossidazione e migliore avacuazione truciolo.

Spiralgenutet oder gerade genutet lieferbar.

Spiral or straight flutes available.

Scarico truciolo elicoidale o diritto.

Torx-Schrauben für einfaches und sicheres Spannen.

Torx screws for easy and secure locking.

Viti Torx.

ARNO Schneideinsatz SHARK-Drill®

ARNO Inserts SHARK-Drill®

ARNO Inserti SHARK-Drill®

Alle Schneideinsätze sind CNC-geschliffen

All inserts are CNC ground

Inserti affilatura CNC

1

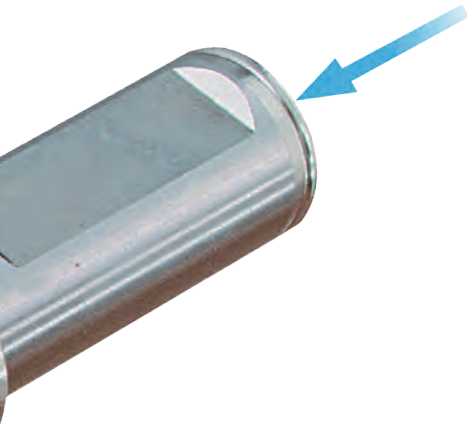

Ausführung mit Kühlmittelring.

Version with coolant adaptor.

Possibile adduzione tramite anello refrigerante su attacchi Cono Morse.

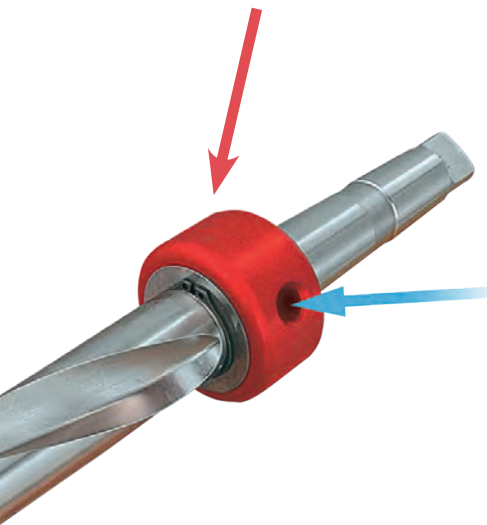

TiN-, TiCN- und TiAlN- Beschichtungen lieferbar. Sonderbeschichtungen auf Anfrage.

TiN-, TiCN- and TiAlN- coatings available. Special coatings on request.

Rivestimenti disponibili TiN, TiCN e TiAlN. Rivestimenti speciali a richiesta.

Eckenschutzfase für höhere Standzeit und Eckenstabilität.

Corner clip protection for better tool life and edge stability.

Spigoli arrotondati per una prolungata vita utensile ed una maggiore stabilità del tagliente.

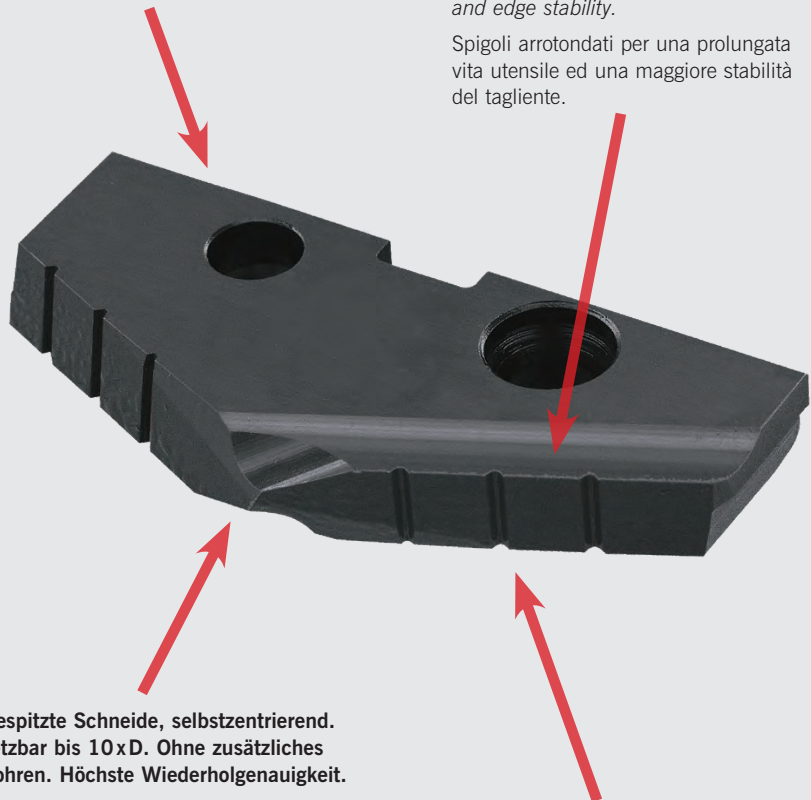

Ausgespitzte Schneide, selbstzentrierend. Einsetzbar bis 10xD. Ohne zusätzliches Vorbohren. Höchste Wiederholgenauigkeit.

Self-centering point allows to drill into solid up to 10xD.

L'inserto autocentrante permette di forare dal pieno fino a 10xD.

Spanbrecher auf allen Platten (außer für Guss bis Ø 18 mm).

Chipbreakers on all insert (except K10 up to Dia. 18 mm).

Rompitruciolo su tutti gli inserti (eccetto K10 fino a Dia 18 mm).

Schneidplatten-Bohrer / Flanged holders / Corpo punta

1

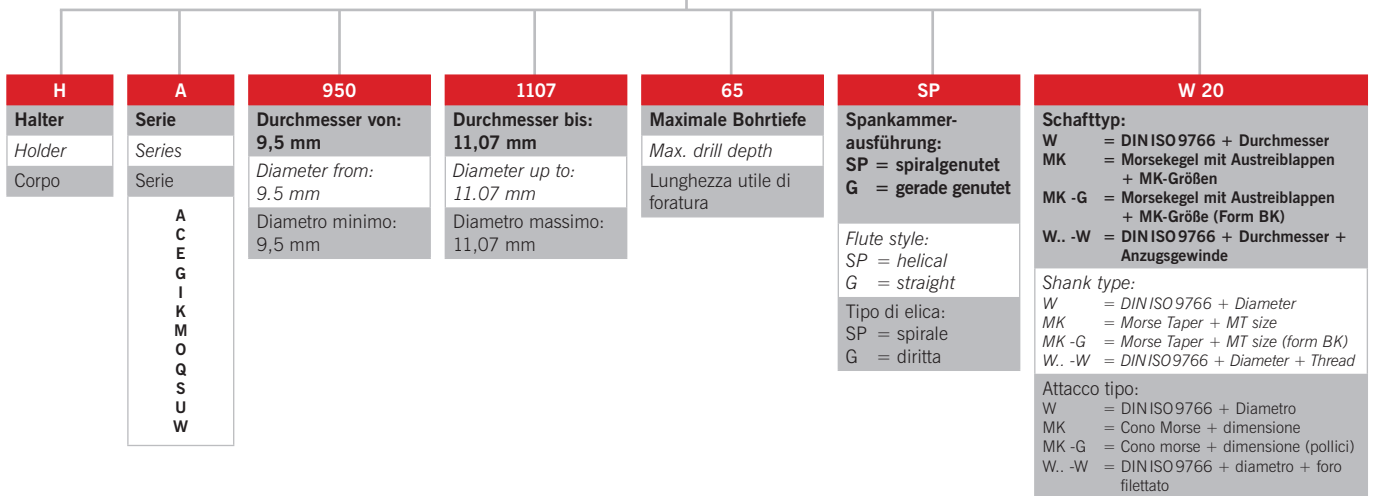

Schneideinsätze / Inserts / Inserti

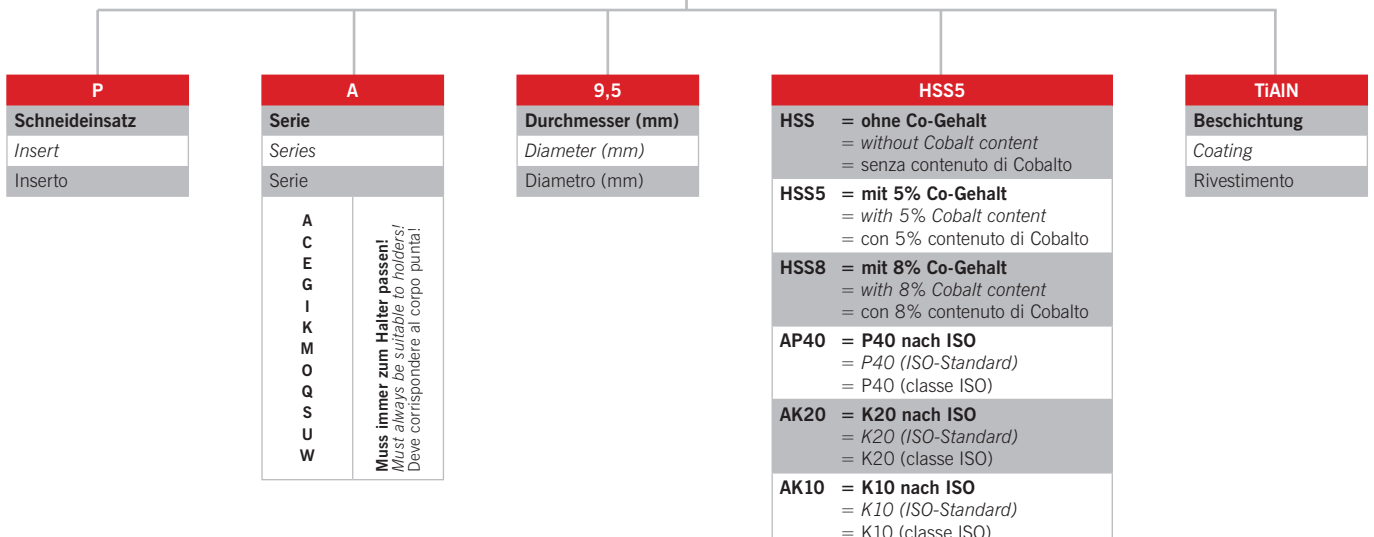

Tool shank options
 Tipologie di attacco utensile

Mit DIN ISO 9766-Schaft

With DIN ISO 9766 shank

Corpo con attacco DIN ISO 9766

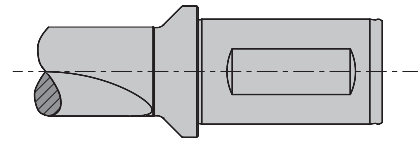

Serie Series Serie	Ø [mm]	max. Bohrtiefe [mm] max. drill depth [mm] Prof. foro max [mm]	Werkzeug auf Seite Tools on page Corpo punta a pagina	Wendeschneidplatte auf Seite Inserts on page Inserto a pagina
A	9,5–11,07	290	38 – 39	75 – 76
C	11,1–12,95	290	39 – 40	76 – 77
E	12,98–17,65	387	41 – 43	78 – 80
G	15,5–17,65	178	41/43	78 – 80
I	17,53–24,38	565	44 – 46	81 – 83
K	22,0–24,38	270	44 – 45	81 – 83
M	24,41–35,05	692	46 – 48	84 – 87
O	30,0–35,05	289	47 – 48	84 – 87
Q	34,37–47,80	787	49 – 50	88 – 89
S	46,99–65,28	879	50 – 51	90 – 91



Mit Morsekegel

With shank holders

Corpo con attacco Morse tipo

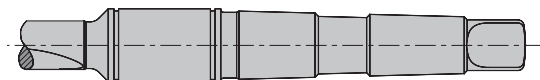

Serie Series Serie	Ø [mm]	max. Bohrtiefe [mm] max. drill depth [mm] Prof. foro max [mm]	Werkzeug auf Seite Tools on page Corpo punta a pagina	Wendeschneidplatte auf Seite Inserts on page Inserto a pagina
A	9,5–11,07	290	52 – 53	75 – 76
C	11,1–12,95	290	53 – 54	76 – 77
E	12,98–17,65	387	55 – 57	78 – 80
G	15,5–17,65	178	55 – 56	78 – 80
I	17,53–24,38	565	57 – 59	81 – 83
K	22,0–24,38	270	58 – 60	81 – 83
M	24,41–35,05	692	60 – 62	84 – 87
O	30,0–35,05	289	61 – 62	84 – 87
Q	34,37–47,80	787	63 – 64	88 – 89
S	46,99–65,28	879	65 – 66	90 – 91
U	62,38–89,08	889	66 – 67	92
W	46,99–65,28	939	68 – 69	93

**Optional mit Morsekegel (-G)
 Erweiterte DIN 228 Form BK**

Optional with morse taper (-G)
 for DIN 228 form BK

Corpo con attacco Morse (-G)
 tipo DIN 228 forma BK



**Optional mit DIN ISO 9766-Schaft (-W)
 und rückseitigem Gewinde nach BSP ISO 7-1**

Optional with DIN ISO 9766 shank (-W)
 for threaded coolant connection to BSP ISO 7-1

Versione corpi (-W)
 con foro filettato BSP ISO 7-1

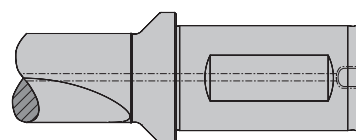

Schneidplatten-Bohrer mit DIN ISO 9766-Schaft

Flanged holders – DIN ISO 9766 shank
Corpo punta – Attacco DIN ISO 9766

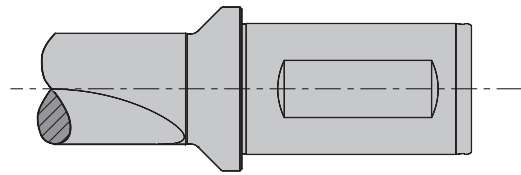

1

Serie/ Series/ Serie A
Ø 9,5 mm – Ø 11,0 mm

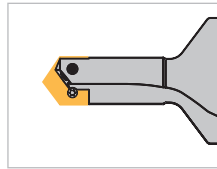

Zylinderschaft – gerade genutet
Straight cylindrical shank – straight flute
Attacco cilindrico – elica diritta

Seite 38 – 39
Page
Pagina

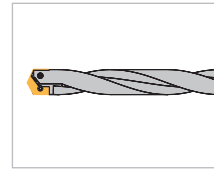

Zylinderschaft – spiralgenutet
Straight cylindrical shank – helical flute
Attacco cilindrico – elica a spirale

Seite 38
Page
Pagina

Serie/ Series/ Serie C
Ø 11,5 mm – Ø 12,8 mm

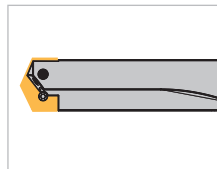

Zylinderschaft – gerade genutet
Straight cylindrical shank – straight flute
Attacco cilindrico – elica diritta

Seite 39 – 40
Page
Pagina

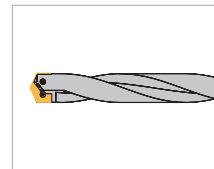

Zylinderschaft – spiralgenutet
Straight cylindrical shank – helical flute
Attacco cilindrico – elica a spirale

Seite 40
Page
Pagina

Serie/ Series/ Serie E+G
Ø 13,0 mm – Ø 17,5 mm

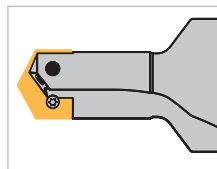

Zylinderschaft – gerade genutet
Straight cylindrical shank – straight flute
Attacco cilindrico – elica diritta

Seite 41/43
Page
Pagina

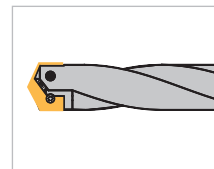

Zylinderschaft – spiralgenutet
Straight cylindrical shank – helical flute
Attacco cilindrico – elica a spirale

Seite 42 – 43
Page
Pagina

Serie/ Series/ Serie I+K
Ø 17,8 mm – Ø 24,0 mm

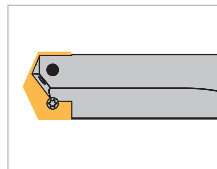

Zylinderschaft – gerade genutet
Straight cylindrical shank – straight flute
Attacco cilindrico – elica diritta

Seite 44/46
Page
Pagina

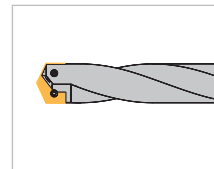

Zylinderschaft – spiralgenutet
Straight cylindrical shank – helical flute
Attacco cilindrico – elica a spirale

Seite 45
Page
Pagina

Serie/ Series/ Serie M+O
Ø 24,5 mm – Ø 35,0 mm

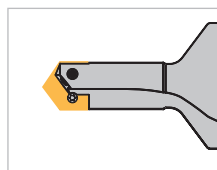

Zylinderschaft – gerade genutet
Straight cylindrical shank – straight flute
Attacco cilindrico – elica diritta

Seite 46 – 48
Page
Pagina

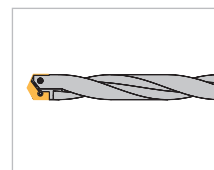

Zylinderschaft – spiralgenutet
Straight cylindrical shank – helical flute
Attacco cilindrico – elica a spirale

Seite 47 – 48
Page
Pagina

Schneidplatten-Bohrer mit DINISO9766-Schaft

Flanged holders – DINISO9766 shank
Corpo punta – Attacco DINISO9766

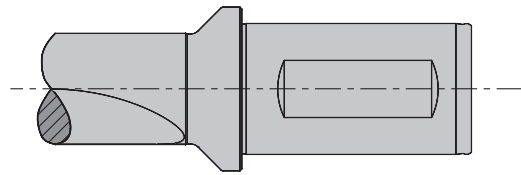

Serie/ Series/ Serie Q
Ø 36,0 mm – Ø 47,0 mm

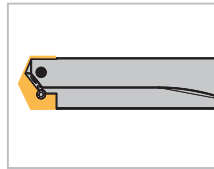

Zylinderschaft – gerade genutet
Straight cylindrical shank – straight flute
Attacco cilindrico – elica diritta

Seite 49 – 50
Page
Pagina

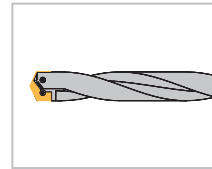

Zylinderschaft – spiralgenutet
Straight cylindrical shank – helical flute
Attacco cilindrico – elica a spirale

Seite 49
Page
Pagina

Serie/ Series/ Serie S
Ø 48,0 mm – Ø 65,0 mm

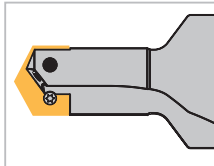

Zylinderschaft – gerade genutet
Straight cylindrical shank – straight flute
Attacco cilindrico – elica diritta

Seite 50 – 51
Page
Pagina

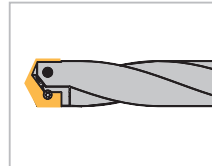

Zylinderschaft – spiralgenutet
Straight cylindrical shank – helical flute
Attacco cilindrico – elica a spirale

Seite 51
Page
Pagina



Schneidplatten-Bohrer mit Morsekegel

Taper shank holders
Corpo con Cono Morse

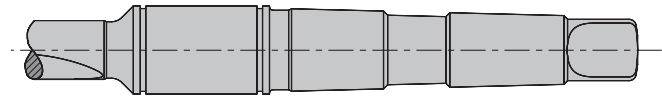

1

Serie / Series / Serie A
Ø 9,5 mm – Ø 11,0 mm

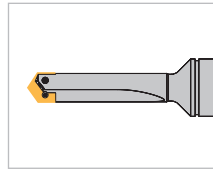

Morsekegelschaft – gerade genutet
Taper shank – straight flute
Attacco Cono Morse – elica diritta

Seite 52
Page
Pagina

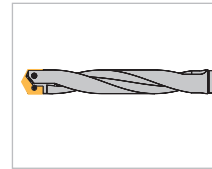

Morsekegelschaft – spiralgenutet
Taper shank – helical flute
Attacco Cono Morse – elica a spirale

Seite 52 – 53
Page
Pagina

Serie / Series / Serie C
Ø 11,5 mm – Ø 12,8 mm

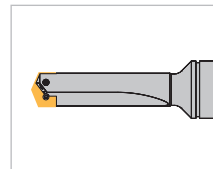

Morsekegelschaft – gerade genutet
Taper shank – straight flute
Attacco Cono Morse – elica diritta

Seite 53
Page
Pagina

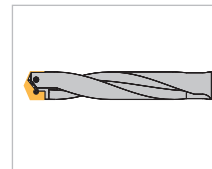

Morsekegelschaft – spiralgenutet
Taper shank – helical flute
Attacco Cono Morse – elica a spirale

Seite 54
Page
Pagina

Serie / Series / Serie E+G
Ø 13,0 mm – Ø 17,5 mm

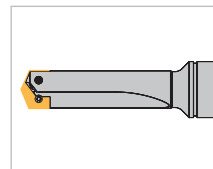

Morsekegelschaft – gerade genutet
Taper shank – straight flute
Attacco Cono Morse – elica diritta

Seite 55
Page
Pagina

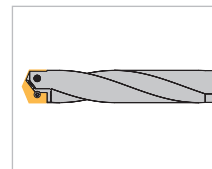

Morsekegelschaft – spiralgenutet
Taper shank – helical flute
Attacco Cono Morse – elica a spirale

Seite 56 – 57
Page
Pagina

Serie / Series / Serie I+K
Ø 17,8 mm – Ø 24,0 mm

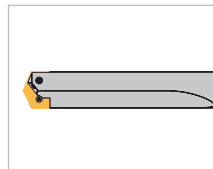

Morsekegelschaft – gerade genutet
Taper shank – straight flute
Attacco Cono Morse – elica diritta

Seite 57 – 58
Page
Pagina

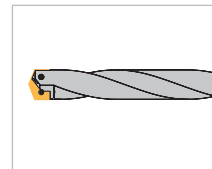

Morsekegelschaft – spiralgenutet
Taper shank – helical flute
Attacco Cono Morse – elica a spirale

Seite 58 – 60
Page
Pagina

Serie / Series / Serie M+O
Ø 24,5 mm – Ø 35,0 mm

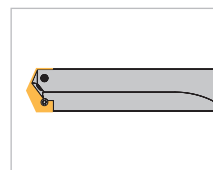

Morsekegelschaft – gerade genutet
Taper shank – straight flute
Attacco Cono Morse – elica diritta

Seite 60 – 61
Page
Pagina

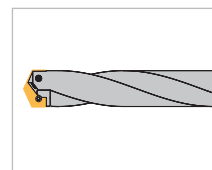

Morsekegelschaft – spiralgenutet
Taper shank – helical flute
Attacco Cono Morse – elica a spirale

Seite 61 – 62
Page
Pagina

Schneidplatten-Bohrer mit Morsekegel

Taper shank holders
Corpo con Cono Morse

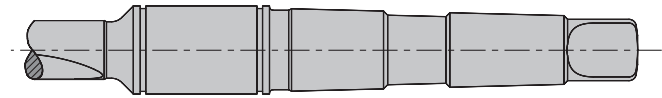

Serie/ Series/ Serie **Q**
Ø 36,0 mm – Ø 47,0 mm

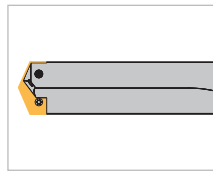

Morsekegelschaft – gerade genutet
Taper shank – straight flute
Attacco Cono Morse – elica diritta

Seite 63 – 64
Page
Pagina

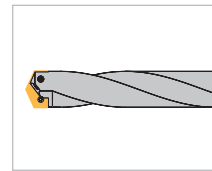

Morsekegelschaft – spiralgenutet
Taper shank – helical flute
Attacco Cono Morse – elica a spirale

Seite 63 – 64
Page
Pagina

Serie/ Series/ Serie **S**
Ø 48,0 mm – Ø 65,0 mm

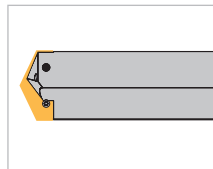

Morsekegelschaft – gerade genutet
Taper shank – straight flute
Attacco Cono Morse – elica diritta

Seite 65 – 66
Page
Pagina

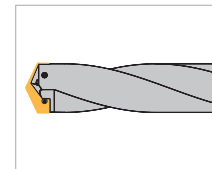

Morsekegelschaft – spiralgenutet
Taper shank – helical flute
Attacco Cono Morse – elica a spirale

Seite 65
Page
Pagina

Serie/ Series/ Serie **U**
Ø 66,0 mm – Ø 89,0 mm

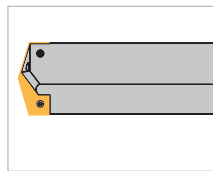

Morsekegelschaft – gerade genutet
Taper shank – straight flute
Attacco Cono Morse – elica diritta

Seite 66 – 67
Page
Pagina

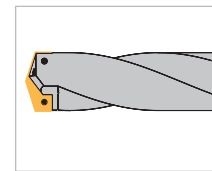

Morsekegelschaft – spiralgenutet
Taper shank – helical flute
Attacco Cono Morse – elica a spirale

Seite 67
Page
Pagina

Serie/ Series/ Serie **W**
Ø 90,0 mm – Ø 114,0 mm

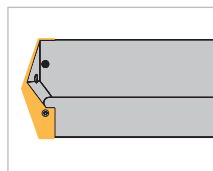

Morsekegelschaft – gerade genutet
Taper shank – straight flute
Attacco Cono Morse – elica diritta

Seite 68 – 69
Page
Pagina

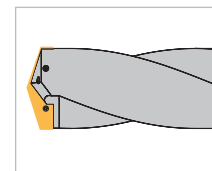

Morsekegelschaft – spiralgenutet
Taper shank – helical flute
Attacco Cono Morse – elica a spirale

Seite 68
Page
Pagina



Schneidplatten-Bohrer mit DIN ISO 9766-Schaft

Flanged holders - DIN ISO 9766 shank
Corpo punta - Attacco DIN ISO 9766

Serie / Series / Serie

A
Ø 9,5 mm – 11,07 mm
1,5 x D – 3 x D

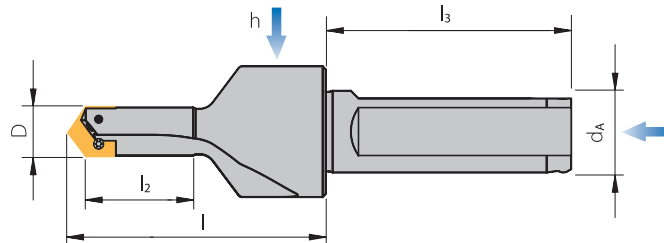

Trägerwerkzeug / Drill holder / Corpo punta

Bezeichnung Designation Articolo	Bohrtiefe Drill depth Profondità foratura	D	l	l ₂	l ₃	h	d _A	MK	Gewinde Thread Filetato
HA950-1107-19GW16	1,5 x D – 2 x D	9,5 – 11,07	50	19	41,9	1/8"	16	-	-
HA950-1107-32GW20	2,5 x D – 3 x D	9,5 – 11,07	63,5	32	41,9	-	20	-	-

Verschlussschraube 20906-G1/8
Grub screw 20906-G1/8
Tappo filetato 20906-G1/8

HINWEIS: Trägerwerkzeuge werden mit Klemmschrauben, 2 Ersatzschrauben und Schlüssel geliefert.
INFORMATION: Holders will be supplied with clamping screws, 2 spare screws and key.
NOTA: L'utensile é fornito completo di 1 vite, 2 viti di ricambio e 1 chiave.

Serie / Series / Serie

A
Ø 9,5 mm – 11,07 mm
5 x D – 11,5 x D

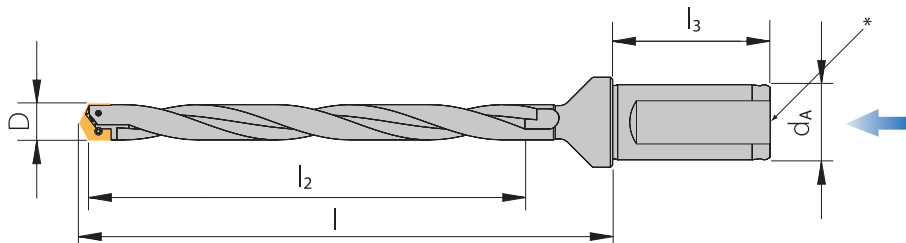

* Gewinde G 1/8"
Thread
Filetato -W

Trägerwerkzeug / Drill holder / Corpo punta

Bezeichnung Designation Articolo	Bohrtiefe Drill depth Profondità foratura	D	l	l ₂	l ₃	h	d _A	MK	Gewinde Thread Filetato
HA950-1107-60SPW20	5 x D – 6 x D	9,5 – 11,07	91,1	60	41,9	-	20	-	-
HA950-1107-86SPW20	7,5 x D – 9 x D	9,5 – 11,07	118,0	86	41,9	-	20	-	-
HA950-1107-111SPW20	10 x D – 11,5 x D	9,5 – 11,07	142,9	111	41,9	-	20	-	-
HA950-1107-111SPW20-W	10 x D – 11,5 x D	9,5 – 11,07	142,9	111	41,9	-	20	-	G 1/8"

HINWEIS: Trägerwerkzeuge werden mit Klemmschrauben, 2 Ersatzschrauben und Schlüssel geliefert.
INFORMATION: Holders will be supplied with clamping screws, 2 spare screws and key.
NOTA: L'utensile é fornito completo di 1 vite, 2 viti di ricambio e 1 chiave.

Zubehör für Bohrer siehe Seite 94 – 95.
Hinweis: Beachten Sie bitte die Anwendungshinweise zu diesen Haltern ab Seite 109!

Holder accessories see page 94 – 95.
Remark: Please see the application guidelines for this holder on page 109!

Accessori corpo a pagina 94 – 95.
Attenzione: Note di utilizzo per questo tipo di utensile a pagina 109!

Schneidplatten-Bohrer mit DIN ISO 9766-Schaft

Flanged holders - DIN ISO 9766 shank
Corpo punta - Attacco DIN ISO 9766

Serie / Series / Serie

A
Ø 9,5 mm – 11,07 mm
20 x D – 30,5 x D

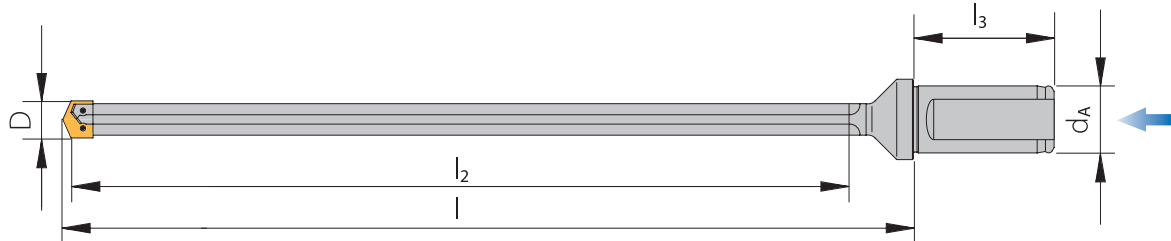

Trägerwerkzeug / Drill holder / Corpo punta

Bezeichnung Designation Articolo	Bohrtiefe Drill depth Profondità foratura	D	l	l ₂	l ₃	h	d _A	MK	Gewinde Thread Filetato
HA950-1107-222GW20	20 x D – 23 x D	9,5 – 11,07	254,1	222	41,9	-	20	-	-
HA950-1107-290GW20	26 x D – 30,5 x D	9,5 – 11,07	322,3	290	41,9	-	20	-	-

HINWEIS: Trägerwerkzeuge werden mit Klemmschrauben, 2 Ersatzschrauben und Schlüssel geliefert.
INFORMATION: Holders will be supplied with clamping screws, 2 spare screws and key.
NOTA: L'utensile é fornito completo di 1 vite, 2 viti di ricambio e 1 chiave.

Serie / Series / Serie

C
Ø 11,1 mm – 12,95 mm
1 x D – 2,5 x D

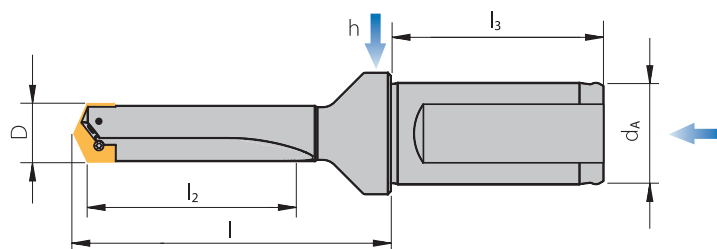

Trägerwerkzeug / Drill holder / Corpo punta

Bezeichnung Designation Articolo	Bohrtiefe Drill depth Profondità foratura	D	l	l ₂	l ₃	h	d _A	MK	Gewinde Thread Filetato
HC1110-1295-19GW16	1 x D – 1,5 x D	11,1 – 12,95	48	19	41,9	1/8"	16	-	-
HC1110-1295-32GW20	2 x D – 2,5 x D	11,1 – 12,95	63,5	32	41,9	-	20	-	-

Verschlusschraube 20906-G1/8
Grub screw 20906-G1/8
Tappo filettato 20906-G1/8

HINWEIS: Trägerwerkzeuge werden mit Klemmschrauben, 2 Ersatzschrauben und Schlüssel geliefert.
INFORMATION: Holders will be supplied with clamping screws, 2 spare screws and key.
NOTA: L'utensile é fornito completo di 1 vite, 2 viti di ricambio e 1 chiave.

Zubehör für Bohrer siehe Seite 94 – 95.

Hinweis: Beachten Sie bitte die Anwendungshinweise zu diesen Haltern ab Seite 109!

Holder accessories see page 94 – 95.

Remark: Please see the application guidelines for this holder on page 109!

Accessori corpo a pagina 94 – 95.

Attenzione: Note di utilizzo per questo tipo di utensile a pagina 109!

Schneidplatten-Bohrer mit DIN ISO 9766-Schaft

Flanged holders - DIN ISO 9766 shank

Corpo punta - Attacco DIN ISO 9766

Serie / Series / Serie

C

Ø 11,1 mm – 12,95 mm

4,5 x D – 16 x D

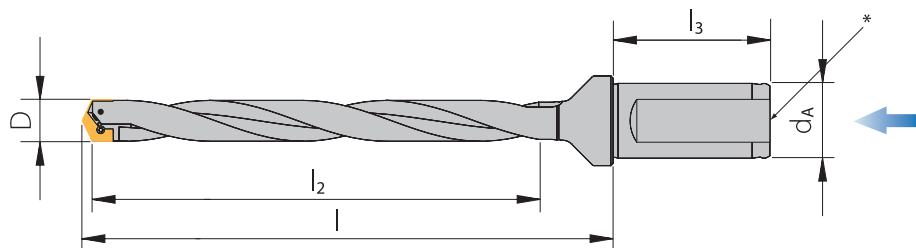

* Gewinde G 1/8"
Thread
Filetato -W

Trägerwerkzeug / Drill holder / Corpo punta

Bezeichnung Designation Articolo	Bohrtiefe Drill depth Profondità foratura	D	l	l ₂	l ₃	h	d _A	MK	Gewinde Thread Filetato
HC1110-1295-60SPW20	4,5 x D – 5 x D	11,1 – 12,95	92,1	60	41,9	-	20	-	-
HC1110-1295-60SPW20-W	4,5 x D – 5 x D	11,1 – 12,95	92,1	60	41,9	-	20	-	G 1/8"
HC1110-1295-86SPW20	6,5 x D – 7,5 x D	11,1 – 12,95	118,0	86	41,9	-	20	-	-
HC1110-1295-111SPW20	8,5 x D – 10 x D	11,1 – 12,95	142,9	111	41,9	-	20	-	-
HC1110-1295-111SPW20-W	8,5 x D – 10 x D	11,1 – 12,95	142,9	111	41,9	-	20	-	G 1/8"
HC1110-1295-180SPW20	13,5 x D – 16 x D	11,1 – 12,95	212,0	180	41,9	-	20	-	-

HINWEIS: Trägerwerkzeuge werden mit Klemmschrauben, 2 Ersatzschrauben und Schlüssel geliefert.

INFORMATION: Holders will be supplied with clamping screws, 2 spare screws and key.

NOTA: L'utensile é fornito completo di 1 vite, 2 viti di ricambio e 1 chiave.

Serie / Series / Serie

C

Ø 11,1 mm – 12,95 mm

17 x D – 26 x D

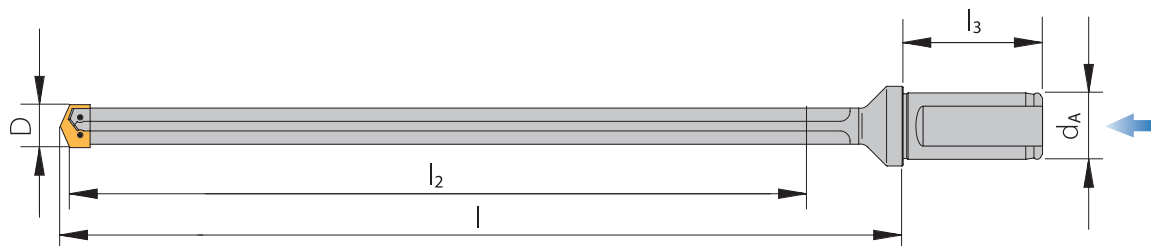

Trägerwerkzeug / Drill holder / Corpo punta

Bezeichnung Designation Articolo	Bohrtiefe Drill depth Profondità foratura	D	l	l ₂	l ₃	h	d _A	MK	Gewinde Thread Filetato
HC1110-1295-222GW20	17 x D – 20 x D	11,1 – 12,95	254,1	222	41,9	-	20	-	-
HC1110-1295-290GW20	22 x D – 26 x D	11,1 – 12,95	322,3	290	41,9	-	20	-	-

HINWEIS: Trägerwerkzeuge werden mit Klemmschrauben, 2 Ersatzschrauben und Schlüssel geliefert.

INFORMATION: Holders will be supplied with clamping screws, 2 spare screws and key.

NOTA: L'utensile é fornito completo di 1 vite, 2 viti di ricambio e 1 chiave.

Schneidplatten-Bohrer mit DIN ISO 9766-Schaft

Flanged holders - DIN ISO 9766 shank
Corpo punta - Attacco DIN ISO 9766

Serie / Series / Serie

E
Ø 12,98 mm – 17,65 mm
1 x D – 2,5 x D

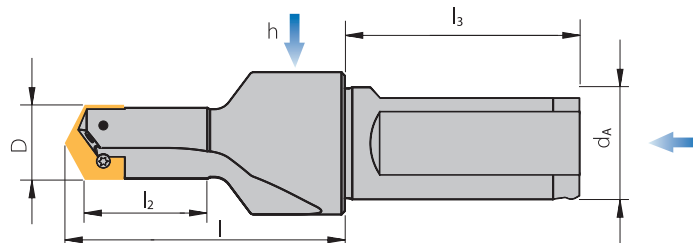

Trägerwerkzeug / Drill holder / Corpo punta

Bezeichnung Designation Articolo	Bohrtiefe Drill depth Profondità foratura	D	l	l ₂	l ₃	h	d _A	MK	Gewinde Thread Filetato
HE1298-1765-22GW20	1 x D – 1,5 x D	12,98 – 17,65	50,4	22	41,9	1/8"	20	-	-
HE1298-1765-35GW20	1,5 x D – 2,5 x D	12,98 – 17,65	66,3	35	41,9	-	20	-	-

HINWEIS: Trägerwerkzeuge werden mit Klemmschrauben, 2 Ersatzschrauben und Schlüssel geliefert.
INFORMATION: Holders will be supplied with clamping screws, 2 spare screws and key.
NOTA: L'utensile é fornito completo di 1 vite, 2 viti di ricambio e 1 chiave.

Serie / Series / Serie

G
Ø 15,5 mm – 17,65 mm
1 x D – 2 x D

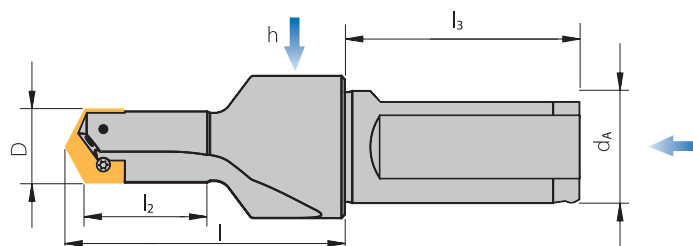

Trägerwerkzeug / Drill holder / Corpo punta

Bezeichnung Designation Articolo	Bohrtiefe Drill depth Profondità foratura	D	l	l ₂	l ₃	h	d _A	MK	Gewinde Thread Filetato
HG1550-1765-22GW20	1 x D – 1,5 x D	15,5 – 17,65	50,4	22	41,9	1/8"	20	-	-
HG1550-1765-35GW20	1,5 x D – 2 x D	15,5 – 17,65	66,3	35	41,9	-	20	-	-

Verschlusschraube 20906-G1/8
Grub screw 20906-G1/8
Tappo filettato 20906-G1/8

HINWEIS: Trägerwerkzeuge werden mit Klemmschrauben, 2 Ersatzschrauben und Schlüssel geliefert.
INFORMATION: Holders will be supplied with clamping screws, 2 spare screws and key.
NOTA: L'utensile é fornito completo di 1 vite, 2 viti di ricambio e 1 chiave.

Zubehör für Bohrer siehe Seite 94 – 95.

Hinweis: Beachten Sie bitte die Anwendungshinweise zu diesen Haltern ab Seite 109!

Holder accessories see page 94 – 95.

Remark: Please see the application guidelines for this holder on page 109!

Accessori corpo a pagina 94 – 95.

Attenzione: Note di utilizzo per questo tipo di utensile a pagina 109!

Schneidplatten-Bohrer mit DIN ISO 9766-Schaft

Flanged holders - DIN ISO 9766 shank

Corpo punta - Attacco DIN ISO 9766

Serie / Series / Serie

E

Ø 12,98 mm – 17,65 mm

3,5 x D – 18 x D

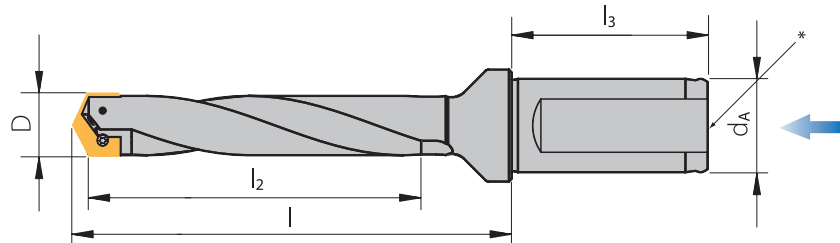

* Gewinde G 1/8"
Thread
Filetato -W

Trägerwerkzeug / Drill holder / Corpo punta

Bezeichnung Designation Articolo	Bohrtiefe Drill depth Profondità foratura	D	l	l ₂	l ₃	h	d _A	MK	Gewinde Thread Filetato
HE1298-1765-64SPW20	3,5 x D – 4,5 x D	12,98 – 17,65	94,9	64	41,9	-	20	-	-
HE1298-1765-64SPW20-W	3,5 x D – 4,5 x D	12,98 – 17,65	94,9	64	41,9	-	20	-	G 1/8"
HE1298-1765-89SPW20	5 x D – 6,5 x D	12,98 – 17,65	120,0	89	41,9	-	20	-	-
HE1298-1765-114SPW20	6 x D – 8,5 x D	12,98 – 17,65	145,7	114	41,9	-	20	-	-
HE1298-1765-114SPW20-W	6 x D – 8,5 x D	12,98 – 17,65	145,7	114	41,9	-	20	-	G 1/8"
HE1298-1765-178SPW20	10 x D – 13,5 x D	12,98 – 17,65	209,1	178	41,9	-	20	-	-
HE1298-1765-178SPW20-W	10 x D – 13,5 x D	12,98 – 17,65	209,1	178	41,9	-	20	-	G 1/8"
HE1298-1765-240SPW20	13,5 x D – 18 x D	12,98 – 17,65	271,0	240	41,9	-	20	-	-

HINWEIS: Trägerwerkzeuge werden mit Klemmschrauben, 2 Ersatzschrauben und Schlüssel geliefert.

INFORMATION: Holders will be supplied with clamping screws, 2 spare screws and key.

NOTA: L'utensile é fornito completo di 1 vite, 2 viti di ricambio e 1 chiave.

Zubehör für Bohrer siehe Seite 94 – 95.

Hinweis: Beachten Sie bitte die Anwendungshinweise zu diesen Haltern ab Seite 109!

Holder accessories see page 94 – 95.

Remark: Please see the application guidelines for this holder on page 109!

Accessori corpo a pagina 94 – 95.

Attenzione: Note di utilizzo per questo tipo di utensile a pagina 109!

Schneidplatten-Bohrer mit DIN ISO 9766-Schaft

Flanged holders - DIN ISO 9766 shank
Corpo punta - Attacco DIN ISO 9766

Serie / Series / Serie

G

Ø 15,5 mm – 17,65 mm
3,5 x D – 11 x D

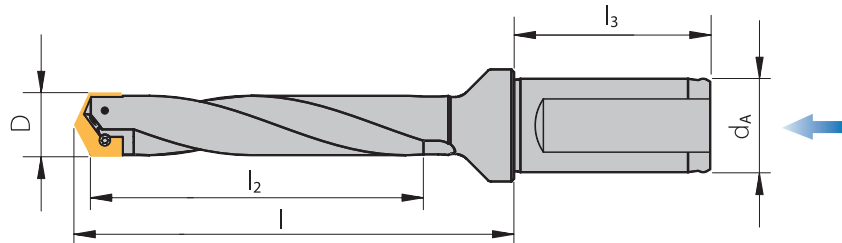

Trägerwerkzeug / Drill holder / Corpo punta

Bezeichnung Designation Articolo	Bohrtiefe Drill depth Profondità foratura	D	l	l ₂	l ₃	h	d _A	MK	Gewinde Thread Filetato
HG1550-1765-64SPW20	3,5 x D – 4 x D	15,5 – 17,65	94,9	64	41,9	-	20	-	-
HG1550-1765-114SPW20	6 x D – 7 x D	15,5 – 17,65	145,7	114	41,9	-	20	-	-
HG1550-1765-178SPW20	10 x D – 11 x D	15,5 – 17,65	209,1	178	41,9	-	20	-	-

HINWEIS: Trägerwerkzeuge werden mit Klemmschrauben, 2 Ersatzschrauben und Schlüssel geliefert.
INFORMATION: Holders will be supplied with clamping screws, 2 spare screws and key.
NOTA: L'utensile é fornito completo di 1 vite, 2 viti di ricambio e 1 chiave.

Serie / Series / Serie

E

Ø 12,98 mm – 17,65 mm
16,5 x D – 29,5 x D

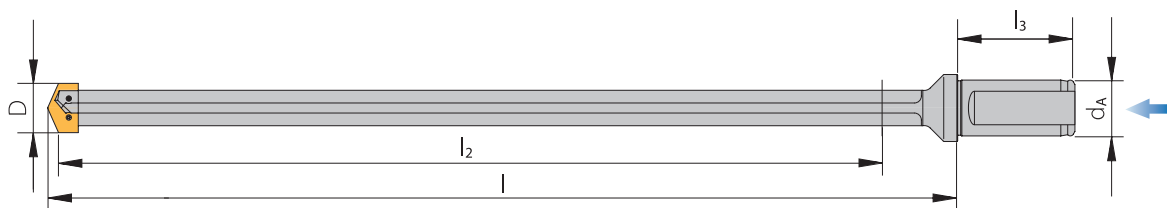
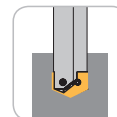

Trägerwerkzeug / Drill holder / Corpo punta

Bezeichnung Designation Articolo	Bohrtiefe Drill depth Profondità foratura	D	l	l ₂	l ₃	h	d _A	MK	Gewinde Thread Filetato
HE1298-1765-295GW20	16,5 x D – 22,5 x D	12,98 – 17,65	326,7	295	41,9	-	20	-	-
HE1298-1765-387GW20	21,5 x D – 29,5 x D	12,98 – 17,65	418,8	387	41,9	-	20	-	-

HINWEIS: Trägerwerkzeuge werden mit Klemmschrauben, 2 Ersatzschrauben und Schlüssel geliefert.
INFORMATION: Holders will be supplied with clamping screws, 2 spare screws and key.
NOTA: L'utensile é fornito completo di 1 vite, 2 viti di ricambio e 1 chiave.

Zubehör für Bohrer siehe Seite 94 – 95.

Hinweis: Beachten Sie bitte die Anwendungshinweise zu diesen Haltern ab Seite 109!

Holder accessories see page 94 – 95.

Remark: Please see the application guidelines for this holder on page 109!

Accessori corpo a pagina 94 – 95.

Attenzione: Note di utilizzo per questo tipo di utensile a pagina 109!

Schneidplatten-Bohrer mit DIN ISO 9766-Schaft

Flanged holders - DIN ISO 9766 shank
Corpo punta - Attacco DIN ISO 9766

Serie / Series / Serie

I
Ø 17,53 mm – 24,38 mm
1,5 x D – 3,5 x D



Seite
Page
Pagina
96 – 119

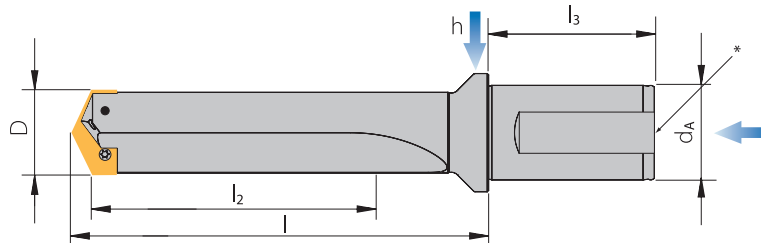

* Gewinde G 1/8"
Thread
Filetato -W

Trägerwerkzeug / Drill holder / Corpo punta

Bezeichnung Designation Articolo	Bohrtiefe Drill depth Profondità foratura	D	l	l ₂	l ₃	h	d _A	MK	Gewinde Thread Filetato
HI1753-2438-47GW25	1,5 x D – 2,5 x D	17,53 – 24,38	79,4	47	53,1	1/8"	25	-	-
HI1753-2438-47GW25-W	1,5 x D – 2,5 x D	17,53 – 24,38	79,4	47	53,1	1/8"	25	-	G 1/8"
HI1753-2438-67GW25	2,5 x D – 3,5 x D	17,53 – 24,38	110,7	67	53,1	-	25	-	-
HI1753-2438-67GW25-W	2,5 x D – 3,5 x D	17,53 – 24,38	110,7	67	53,1	-	25	-	G 1/8"

HINWEIS: Trägerwerkzeuge werden mit Klemmschrauben, 2 Ersatzschrauben und Schlüssel geliefert.
INFORMATION: Holders will be supplied with clamping screws, 2 spare screws and key.
NOTA: L' utensile é fornito completo di 1 vite, 2 viti di ricambio e 1 chiave.

Serie / Series / Serie

K
Ø 22,0 mm – 24,38 mm
2 x D – 3 x D



Seite
Page
Pagina
96 – 119

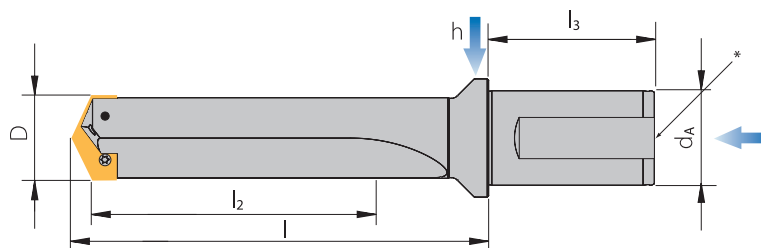

* Gewinde G 1/8"
Thread
Filetato -W

Trägerwerkzeug / Drill holder / Corpo punta

Bezeichnung Designation Articolo	Bohrtiefe Drill depth Profondità foratura	D	l	l ₂	l ₃	h	d _A	MK	Gewinde Thread Filetato
HK2200-2438-57GW25	2 x D – 2,5 x D	22,0 – 24,38	92,1	57	53,1	1/8"	25	-	-
HK2200-2438-67GW25	2,5 x D – 3 x D	22,0 – 24,38	110,7	67	53,1	-	25	-	-

Verschlusschraube 20906-G1/8
Grub screw 20906-G 1/8
Tappo filetato 20906-G1/8

HINWEIS: Trägerwerkzeuge werden mit Klemmschrauben, 2 Ersatzschrauben und Schlüssel geliefert.
INFORMATION: Holders will be supplied with clamping screws, 2 spare screws and key.
NOTA: L' utensile é fornito completo di 1 vite, 2 viti di ricambio e 1 chiave.

Hinweis: Beachten Sie bitte die Anwendungshinweise zu diesen Haltern ab Seite 109!
Holder accessories see page 94 – 95.

Remark: Please see the application guidelines for this holder on page 109!

Accessori corpo a pagina 94 – 95.
Attenzione: Note di utilizzo per questo tipo di utensile a pagina 109!

Schneidplatten-Bohrer mit DIN ISO 9766-Schaft

Flanged holders - DIN ISO 9766 shank

Corpo punta - Attacco DIN ISO 9766

Serie / Series / Serie

I

Ø 17,53 mm – 24,38 mm

4,5 x D – 20,5 x D

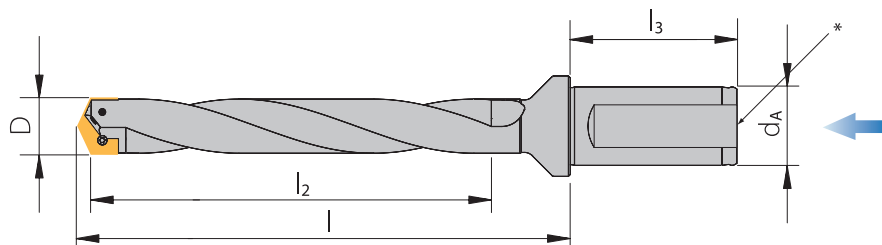

* Gewinde G 1/8"
Thread
Filetato -W

1

Trägerwerkzeug / Drill holder / Corpo punta

Bezeichnung Designation Articolo	Bohrtiefe Drill depth Profondità foratura	D	l	l ₂	l ₃	h	d _A	MK	Gewinde Thread Filetato
HI1753-2438-118SPW25	4,5 x D – 6,5 x D	17,53 – 24,38	158,4	118	53,1	-	25	-	-
HI1753-2438-168SPW25	6,5 x D – 9,5 x D	17,53 – 24,38	209,2	168	53,1	-	25	-	-
HI1753-2438-168SPW25-W	6,5 x D – 9,5 x D	17,53 – 24,38	209,2	168	53,1	-	25	-	G 1/8"
HI1753-2438-219SPW25	8,5 x D – 12 x D	17,53 – 24,38	260,0	219	53,1	-	25	-	-
HI1753-2438-270SPW25	11 x D – 15 x D	17,53 – 24,38	310,8	270	53,1	-	25	-	-
HI1753-2438-365SPW25	14,5 x D – 20,5 x D	17,53 – 24,38	406,0	365	53,1	-	25	-	-

HINWEIS: Trägerwerkzeuge werden mit Klemmschrauben, 2 Ersatzschrauben und Schlüssel geliefert.

INFORMATION: Holders will be supplied with clamping screws, 2 spare screws and key.

NOTA: L'utensile é fornito completo di 1 vite, 2 viti di ricambio e 1 chiave.

Serie / Series / Serie

K

Ø 22,0 mm – 24,38 mm

4,5 x D – 12 x D

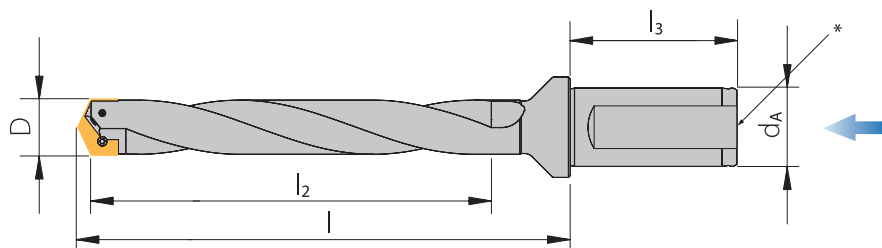

* Gewinde G 1/8"
Thread
Filetato -W

Trägerwerkzeug / Drill holder / Corpo punta

Bezeichnung Designation Articolo	Bohrtiefe Drill depth Profondità foratura	D	l	l ₂	l ₃	h	d _A	MK	Gewinde Thread Filetato
HK2200-2438-118SPW25	4,5 x D – 5 x D	22,0 – 24,38	158,4	118	53,1	-	25	-	-
HK2200-2438-168SPW25	6,5 x D – 7,5 x D	22,0 – 24,38	209,2	168	53,1	-	25	-	-
HK2200-2438-270SPW25	11 x D – 12 x D	22,0 – 24,38	310,8	270	53,1	-	25	-	-

HINWEIS: Trägerwerkzeuge werden mit Klemmschrauben, 2 Ersatzschrauben und Schlüssel geliefert.

INFORMATION: Holders will be supplied with clamping screws, 2 spare screws and key.

NOTA: L'utensile é fornito completo di 1 vite, 2 viti di ricambio e 1 chiave.

Schneidplatten-Bohrer mit DIN ISO 9766-Schaft

Flanged holders - DIN ISO 9766 shank
Corpo punta - Attacco DIN ISO 9766

Serie / Series / Serie

I
Ø 17,53 mm – 24,38 mm
18,5 x D – 32 x D

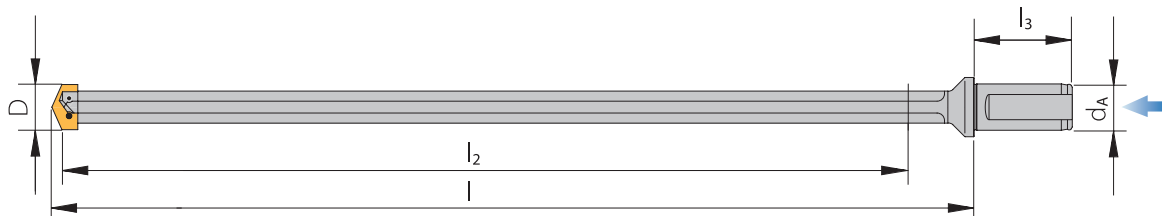

Trägerwerkzeug / Drill holder / Corpo punta

Bezeichnung Designation Articolo	Bohrtiefe Drill depth Profondità foratura	D	l	l ₂	l ₃	h	d _A	MK	Gewinde Thread Filetato
HI1753-2438-457GW25	18,5 x D – 26 x D	17,53 – 24,38	498,1	457	53,1	-	25	-	-
HI1753-2438-565GW25	23 x D – 32 x D	17,53 – 24,38	606,1	565	53,1	-	25	-	-

HINWEIS: Trägerwerkzeuge werden mit Klemmschrauben, 2 Ersatzschrauben und Schlüssel geliefert.
INFORMATION: Holders will be supplied with clamping screws, 2 spare screws and key.
NOTA: L'utensile é fornito completo di 1 vite, 2 viti di ricambio e 1 chiave.

Serie / Series / Serie

M
Ø 24,41 mm – 35,05 mm
1,5 x D – 3,5 x D

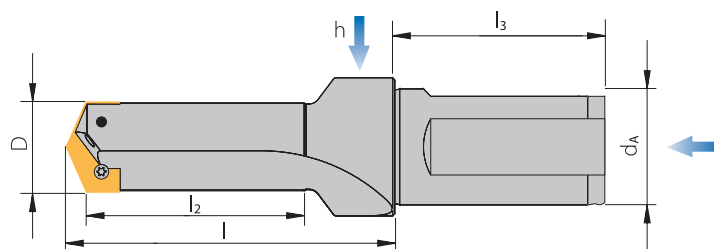

Trägerwerkzeug / Drill holder / Corpo punta

Bezeichnung Designation Articolo	Bohrtiefe Drill depth Profondità foratura	D	l	l ₂	l ₃	h	d _A	MK	Gewinde Thread Filetato
HM2441-3505-57GW32	1,5 x D – 2 x D	24,41 – 35,05	92,1	57	57,9	1/8"	32	-	-
HM2441-3505-86GW32	2 x D – 3,5 x D	24,41 – 35,05	132,2	86	57,9	-	32	-	-
HM2441-3505-86GW32-W	2 x D – 3,5 x D	24,41 – 35,05	132,2	86	57,9	-	32	-	G 1/4"

HINWEIS: Trägerwerkzeuge werden mit Klemmschrauben, 2 Ersatzschrauben und Schlüssel geliefert.
INFORMATION: Holders will be supplied with clamping screws, 2 spare screws and key.
NOTA: L'utensile é fornito completo di 1 vite, 2 viti di ricambio e 1 chiave.

Zubehör für Bohrer siehe Seite 94 – 95.
Hinweis: Beachten Sie bitte die Anwendungshinweise zu diesen Haltern ab Seite 109!

Holder accessories see page 94 – 95.
Remark: Please see the application guidelines for this holder on page 109!

Accessori corpo a pagina 94 – 95.
Attenzione: Note di utilizzo per questo tipo di utensile a pagina 109!

Schneidplatten-Bohrer mit DIN ISO 9766-Schaft

Flanged holders - DIN ISO 9766 shank

Corpo punta - Attacco DIN ISO 9766

Serie / Series / Serie

O

Ø 30,0 mm – 35,05 mm

2 x D – 3,5 x D

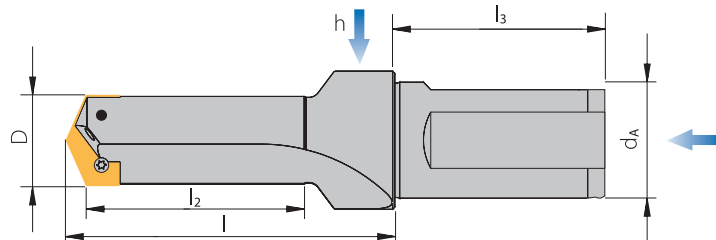

Trägerwerkzeug / Drill holder / Corpo punta

Bezeichnung Designation Articolo	Bohrtiefe Drill depth Profondità foratura	D	l	l ₂	l ₃	h	d _A	MK	Gewinde Thread Filetato
HO3000-3505-86GW32	2 x D – 3,5 x D	30,0 – 35,05	132,2	86	57,9	-	32	-	-
HO3000-3505-92GW32	2,5 x D – 3,5 x D	30,0 – 35,05	127	92	57,9	1/8"	32	-	-

Verschlussschraube 20906-G1/8
Grub screw 20906-G1/8
Tappo filetato 20906-G1/8

HINWEIS: Trägerwerkzeuge werden mit Klemmschrauben, 2 Ersatzschrauben und Schlüssel geliefert.

INFORMATION: Holders will be supplied with clamping screws, 2 spare screws and key.

NOTA: L'utensile é fornito completo di 1 vite, 2 viti di ricambio e 1 chiave.

Serie / Series / Serie

M

Ø 24,41 mm – 35,05 mm

3,5 x D – 16,5 x D

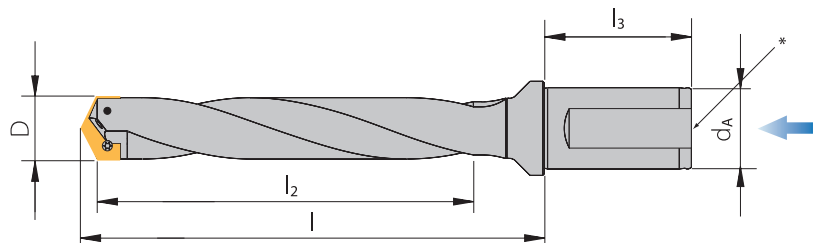

* Gewinde G 1/4"
Thread
Filetato -W

Trägerwerkzeug / Drill holder / Corpo punta

Bezeichnung Designation Articolo	Bohrtiefe Drill depth Profondità foratura	D	l	l ₂	l ₃	h	d _A	MK	Gewinde Thread Filetato
HM2441-3505-137SPW32	3,5 x D – 5,5 x D	24,41 – 35,05	183,0	137	57,9	-	32	-	-
HM2441-3505-137SPW32-W	3,5 x D – 5,5 x D	24,41 – 35,05	183,0	137	57,9	-	32	G 1/4"	-
HM2441-3505-187SPW32	5 x D – 7,5 x D	24,41 – 35,05	233,8	187	57,9	-	32	-	-
HM2441-3505-187SPW32-W	5 x D – 7,5 x D	24,41 – 35,05	233,8	187	57,9	-	32	G 1/4"	-
HM2441-3505-238SPW32	6,5 x D – 9,5 x D	24,41 – 35,05	285,0	238	57,9	-	32	-	-
HM2441-3505-289SPW32	8 x D – 11,5 x D	24,41 – 35,05	335,4	289	57,9	-	32	-	-
HM2441-3505-289SPW32-W	8 x D – 11,5 x D	24,41 – 35,05	335,4	289	57,9	-	32	G 1/4"	-
HM2441-3505-410SPW32	11,5 x D – 16,5 x D	24,41 – 35,05	456,5	410	57,9	-	32	-	-

HINWEIS: Trägerwerkzeuge werden mit Klemmschrauben, 2 Ersatzschrauben und Schlüssel geliefert.

INFORMATION: Holders will be supplied with clamping screws, 2 spare screws and key.

NOTA: L'utensile é fornito completo di 1 vite, 2 viti di ricambio e 1 chiave.

Schneidplatten-Bohrer mit DIN ISO 9766-Schaft

Flanged holders - DIN ISO 9766 shank
Corpo punta - Attacco DIN ISO 9766

Serie / Series / Serie

O
Ø 30,0 mm – 35,05 mm
3,5 x D – 11,5 x D

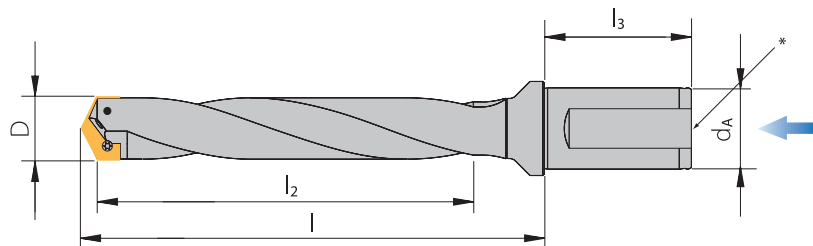

* Gewinde G 1/4"
Thread
Filetato -W

Trägerwerkzeug / Drill holder / Corpo punta

Bezeichnung Designation Articolo	Bohrtiefe Drill depth Profondità foratura	D	l	l ₂	l ₃	h	d _A	MK	Gewinde Thread Filetato
HO3000-3505-137SPW32	3,5 x D – 5,5 x D	30,0 – 35,05	183	137	57,9	-	32	-	-
HO3000-3505-187SPW32	5 x D – 7,5 x D	30,0 – 35,05	233,8	187	57,9	-	32	-	-
HO3000-3505-289SPW32	8 x D – 11,5 x D	30,0 – 35,05	335,4	289	57,9	-	32	-	-

HINWEIS: Trägerwerkzeuge werden mit Klemmschrauben, 2 Ersatzschrauben und Schlüssel geliefert.
INFORMATION: Holders will be supplied with clamping screws, 2 spare screws and key.
NOTA: L'utensile é fornito completo di 1 vite, 2 viti di ricambio e 1 chiave.

Serie / Series / Serie

M
Ø 24,41 mm – 35,05 mm
14,5 x D – 28 x D

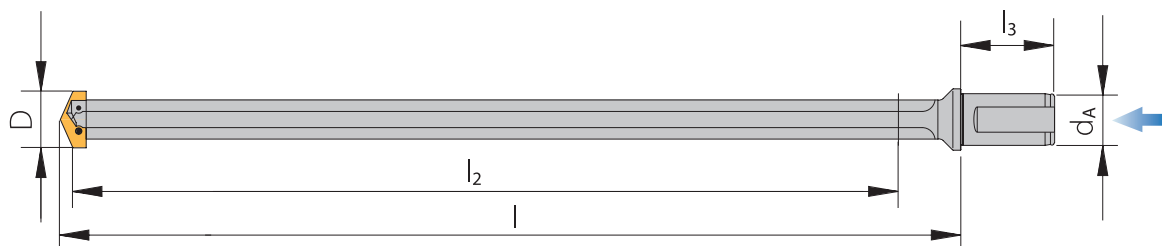

Trägerwerkzeug / Drill holder / Corpo punta

Bezeichnung Designation Articolo	Bohrtiefe Drill depth Profondità foratura	D	l	l ₂	l ₃	h	d _A	MK	Gewinde Thread Filetato
HM2441-3505-511GW32	14,5 x D – 20,5 x D	24,41 – 35,05	557,7	511	57,9	-	32	-	-
HM2441-3505-692GW32	19,5 x D – 28 x D	24,41 – 35,05	738,7	692	57,9	-	32	-	-

HINWEIS: Trägerwerkzeuge werden mit Klemmschrauben, 2 Ersatzschrauben und Schlüssel geliefert.
INFORMATION: Holders will be supplied with clamping screws, 2 spare screws and key.
NOTA: L'utensile é fornito completo di 1 vite, 2 viti di ricambio e 1 chiave.

Zubehör für Bohrer siehe Seite 94 – 95.
Hinweis: Beachten Sie bitte die Anwendungshinweise zu diesen Haltern ab Seite 109!

Holder accessories see page 94 – 95.
Remark: Please see the application guidelines for this holder on page 109!

Accessori corpo a pagina 94 – 95.
Attenzione: Note di utilizzo per questo tipo di utensile a pagina 109!

Schneidplatten-Bohrer mit DIN ISO 9766-Schaft

Flanged holders - DIN ISO 9766 shank
Corpo punta - Attacco DIN ISO 9766

Serie / Series / Serie

Q
Ø 34,37 mm – 47,8 mm
1,5 x D – 3,5 x D

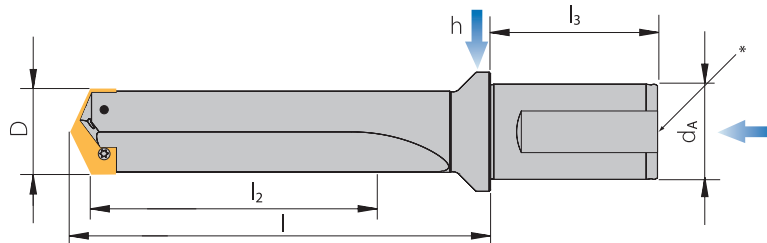

* Gewinde G 1/4"
Thread
Filetato -W

Trägerwerkzeug / Drill holder / Corpo punta

Bezeichnung Designation Articolo	Bohrtiefe Drill depth Profondità foratura	D	l	l ₂	l ₃	h	d _A	MK	Gewinde Thread Filetato
HQ3437-4780-76GW40	1,5 x D – 2 x D	34,37 – 47,8	129,8	76	70,1	1/4"	40	-	-
HQ3437-4780-76GW40-W	1,5 x D – 2 x D	34,37 – 47,8	129,8	76	70,1	-	40	-	G 1/4"
HQ3437-4780-121GW40	2,5 x D – 3,5 x D	34,37 – 47,8	177,8	121	70,1	-	40	-	-
HQ3437-4780-121GW40-W	2,5 x D – 3,5 x D	34,37 – 47,8	177,8	121	70,1	-	40	-	G 1/4"

Verschlusschraube 20906-G1/8
Grub screw 20906-G1/8
Tappo filetato 20906-G1/8

HINWEIS: Trägerwerkzeuge werden mit Klemmschrauben, 2 Ersatzschrauben und Schlüssel geliefert.
INFORMATION: Holders will be supplied with clamping screws, 2 spare screws and key.
NOTA: L'utensile é fornito completo di 1 vite, 2 viti di ricambio e 1 chiave.

Serie / Series / Serie

Q
Ø 34,37 mm – 47,8 mm
3 x D – 6 x D

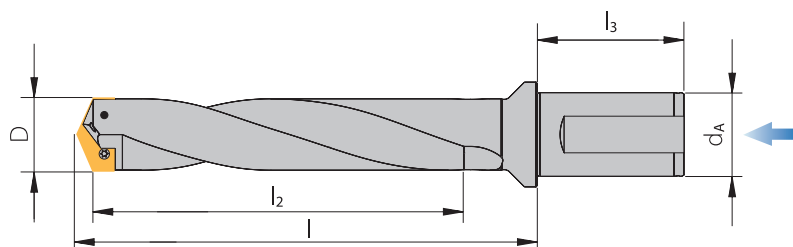

Trägerwerkzeug / Drill holder / Corpo punta

Bezeichnung Designation Articolo	Bohrtiefe Drill depth Profondità foratura	D	l	l ₂	l ₃	h	d _A	MK	Gewinde Thread Filetato
HQ3437-4780-165SPW40	3 x D – 4,5 x D	34,37 – 47,8	222,3	165	70,1	-	40	-	-
HQ3437-4780-165SPW40-W	3 x D – 4,5 x D	34,37 – 47,8	222,3	165	70,1	-	40	-	G 1/4"
HQ3437-4780-210SPW40	4 x D – 6 x D	34,37 – 47,8	266,7	210	70,1	-	40	-	-
HQ3437-4780-210SPW40-W	4 x D – 6 x D	34,37 – 47,8	266,7	210	70,1	-	40	-	G 1/4"

HINWEIS: Trägerwerkzeuge werden mit Klemmschrauben, 2 Ersatzschrauben und Schlüssel geliefert.
INFORMATION: Holders will be supplied with clamping screws, 2 spare screws and key.
NOTA: L'utensile é fornito completo di 1 vite, 2 viti di ricambio e 1 chiave.

Schneidplatten-Bohrer mit DIN ISO 9766-Schaft

Flanged holders - DIN ISO 9766 shank
Corpo punta - Attacco DIN ISO 9766

Serie / Series / Serie

Q

Ø 34,37 mm – 47,8 mm
7 x D – 22,5 x D

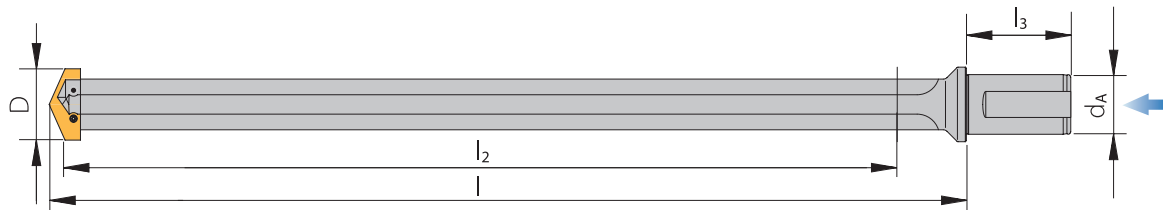

Trägerwerkzeug / Drill holder / Corpo punta

Bezeichnung Designation Articolo	Bohrtiefe Drill depth Profondità foratura	D	l	l ₂	l ₃	h	d _A	MK	Gewinde Thread Filetato
HQ3437-4780-349GW40	7 x D – 10 x D	34,37 – 47,8	406,4	349	70,1	-	40	-	-
HQ3437-4780-558GW40	11,5 x D – 16 x D	34,37 – 47,8	615,9	558	70,1	-	40	-	-
HQ3437-4780-787GW40	16 x D – 22,5 x D	34,37 – 47,8	844,5	787	70,1	-	40	-	-

HINWEIS: Trägerwerkzeuge werden mit Klemmschrauben, 2 Ersatzschrauben und Schlüssel geliefert.
INFORMATION: Holders will be supplied with clamping screws, 2 spare screws and key.
NOTA: L'utensile é fornito completo di 1 vite, 2 viti di ricambio e 1 chiave.

Serie / Series / Serie

S

Ø 46,99 mm – 65,28 mm
1,5 x D – 2,5 x D

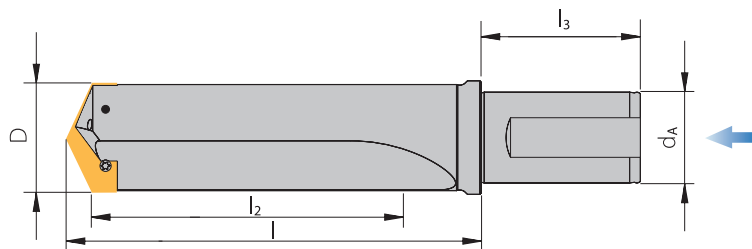

Trägerwerkzeug / Drill holder / Corpo punta

Bezeichnung Designation Articolo	Bohrtiefe Drill depth Profondità foratura	D	l	l ₂	l ₃	h	d _A	MK	Gewinde Thread Filetato
HS4699-6528-130GW40	1,5 x D – 2,5 x D	46,99 – 65,28	184,2	130	70,1	-	40	-	-
HS4699-6528-130GW40-W	1,5 x D – 2,5 x D	46,99 – 65,28	184,2	130	70,1	-	40	-	G 1/4"

HINWEIS: Trägerwerkzeuge werden mit Klemmschrauben, 2 Ersatzschrauben und Schlüssel geliefert.
INFORMATION: Holders will be supplied with clamping screws, 2 spare screws and key.
NOTA: L'utensile é fornito completo di 1 vite, 2 viti di ricambio e 1 chiave.

Zubehör für Bohrer siehe Seite 94 – 95.
Hinweis: Beachten Sie bitte die Anwendungshinweise zu diesen Haltern ab Seite 109!

Holder accessories see page 94 – 95.
Remark: Please see the application guidelines for this holder on page 109!

Accessori corpo a pagina 94 – 95.
Attenzione: Note di utilizzo per questo tipo di utensile a pagina 109!

Schneidplatten-Bohrer mit DIN ISO 9766-Schaft

Flanged holders - DIN ISO 9766 shank
Corpo punta - Attacco DIN ISO 9766

Serie / Series / Serie

S

Ø 46,99 mm – 65,28 mm
3,5 x D – 4,5 x D

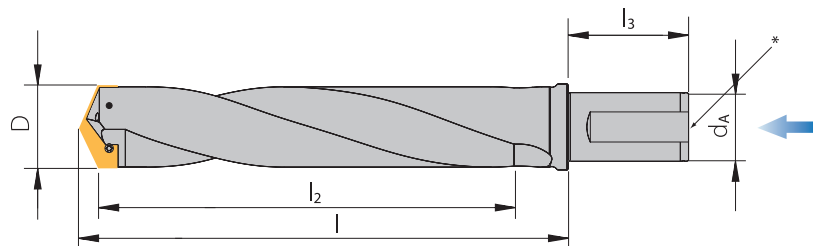

* Gewinde G 1/4"
Thread
Filetato -W

Trägerwerkzeug / Drill holder / Corpo punta

Bezeichnung Designation Articolo	Bohrtiefe Drill depth Profondità foratura	D	l	l ₂	l ₃	h	d _A	MK	Gewinde Thread Filetato
HS4699-6528-232SPW40	3,5 x D – 4,5 x D	46,99 – 65,28	285,8	232	70,1	-	40	-	-
HS4699-6528-232SPW40-W	3,5 x D – 4,5 x D	46,99 – 65,28	285,8	232	70,1	-	40	-	G 1/4"

HINWEIS: Trägerwerkzeuge werden mit Klemmschrauben, 2 Ersatzschrauben und Schlüssel geliefert.
INFORMATION: Holders will be supplied with clamping screws, 2 spare screws and key.
NOTA: L'utensile é fornito completo di 1 vite, 2 viti di ricambio e 1 chiave.

Serie / Series / Serie

S

Ø 46,99 mm – 65,28 mm
6 x D – 18,5 x D

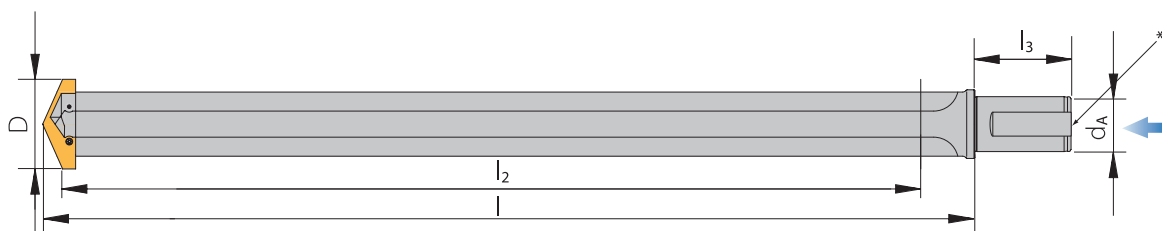

* Gewinde G 1/4"
Thread
Filetato -W

Trägerwerkzeug / Drill holder / Corpo punta

Bezeichnung Designation Articolo	Bohrtiefe Drill depth Profondità foratura	D	l	l ₂	l ₃	h	d _A	MK	Gewinde Thread Filetato
HS4699-6528-422GW40	6 x D – 8,5 x D	46,99 – 65,28	476,3	422	70,1	-	40	-	-
HS4699-6528-422GW40-W	6 x D – 8,5 x D	46,99 – 65,28	476,3	422	70,1	-	40	-	G 1/4"
HS4699-6528-625GW40	9,5 x D – 13 x D	46,99 – 65,28	679,5	625	70,1	-	40	-	-
HS4699-6528-879GW40	13 x D – 18,5 x D	46,99 – 65,28	933,5	879	70,1	-	40	-	-

HINWEIS: Trägerwerkzeuge werden mit Klemmschrauben, 2 Ersatzschrauben und Schlüssel geliefert.
INFORMATION: Holders will be supplied with clamping screws, 2 spare screws and key.
NOTA: L'utensile é fornito completo di 1 vite, 2 viti di ricambio e 1 chiave.

Zubehör für Bohrer siehe Seite 94 – 95.

Hinweis: Beachten Sie bitte die Anwendungshinweise zu diesen Haltern ab Seite 109!

Holder accessories see page 94 – 95.

Remark: Please see the application guidelines for this holder on page 109!

Accessori corpo a pagina 94 – 95.

Attenzione: Note di utilizzo per questo tipo di utensile a pagina 109!

Schneidplatten-Bohrer mit Morsekegel

Taper shank holders
Corpo con Cono Morse

Serie / Series / Serie

A
Ø 9,5 mm – 11,07 mm
2,5 x D – 3 x D

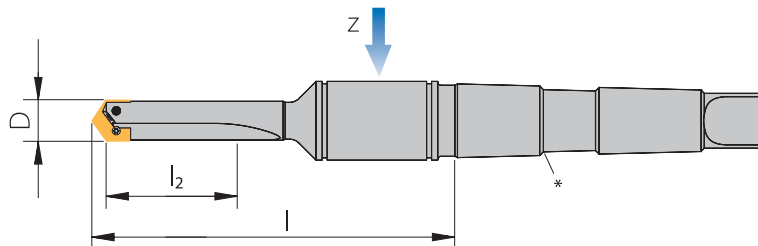

* Morsekegel (MK) nach DIN ISO 296
Taper shank (MK) to DIN ISO 296
Cono Morse (MK) secondo DIN ISO 296

Trägerwerkzeug / Drill holder / Corpo punta

Bezeichnung Designation Articolo	Bohrtiefe Drill depth Profondità foratura	D	l	l ₂	l ₃	d _A	z	MK
HA950-1107-32GMK2	2,5 x D – 3 x D	9,5 – 11,07	88	32	-	-	2KDA	MK2

HINWEIS: Trägerwerkzeuge werden mit Klemmschrauben, 2 Ersatzschrauben und Schlüssel geliefert.
INFORMATION: Holders will be supplied with clamping screws, 2 spare screws and key.
NOTA: L'utensile é fornito completo di 1 vite, 2 viti di ricambio e 1 chiave.

Serie / Series / Serie

A
Ø 9,5 mm – 11,07 mm
5 x D – 11,5 x D

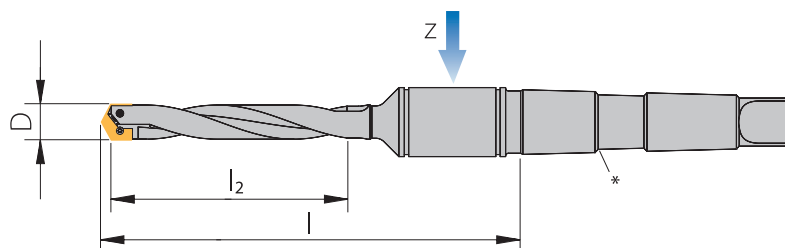

* Morsekegel (MK) nach DIN ISO 296
Taper shank (MK) to DIN ISO 296
Cono Morse (MK) secondo DIN ISO 296

Trägerwerkzeug / Drill holder / Corpo punta

Bezeichnung Designation Articolo	Bohrtiefe Drill depth Profondità foratura	D	l	l ₂	l ₃	d _A	z	MK
HA950-1107-60SPMK2	5 x D – 6 x D	9,5 – 11,07	116,7	60	-	-	2KDA	MK2
HA950-1107-111SPMK2	10 x D – 11,5 x D	9,5 – 11,07	167,4	111	-	-	2KDA	MK2

HINWEIS: Trägerwerkzeuge werden mit Klemmschrauben, 2 Ersatzschrauben und Schlüssel geliefert.
INFORMATION: Holders will be supplied with clamping screws, 2 spare screws and key.
NOTA: L'utensile é fornito completo di 1 vite, 2 viti di ricambio e 1 chiave.

Zubehör für Bohrer siehe Seite 94 – 95.
Hinweis: Beachten Sie bitte die Anwendungshinweise zu diesen Haltern ab Seite 109!

Holder accessories see page 94 – 95.
Remark: Please see the application guidelines for this holder on page 109!

Accessori corpo a pagina 94 – 95.
Attenzione: Note di utilizzo per questo tipo di utensile a pagina 109!

Schneidplatten-Bohrer mit Morsekegel

Taper shank holders
Corpo con Cono Morse

Serie / Series / Serie

A
Ø 9,5 mm – 11,07 mm
10 x D – 11,5 x D

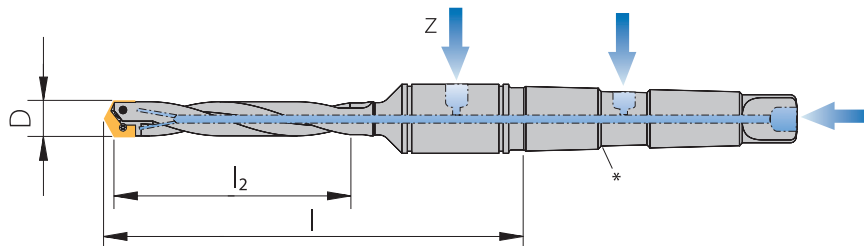

* Morsekegel (MK) nach DIN ISO 296
Taper shank (MK) to DIN ISO 296
Cono Morse (MK) secondo DIN ISO 296

Trägerwerkzeug / Drill holder / Corpo punta

Bezeichnung Designation Articolo	Bohrtiefe Drill depth Profondità foratura	D	l	l ₂	l ₃	d _A	z	MK
HA950-1107-111SPMK2-G	10 x D – 11,5 x D	9,5 – 11,07	167,4	111	-	-	2KDA	MK2

HINWEIS: Trägerwerkzeuge werden mit Klemmschrauben, 2 Ersatzschrauben und Schlüssel geliefert.
INFORMATION: Holders will be supplied with clamping screws, 2 spare screws and key.
NOTA: L'utensile é fornito completo di 1 vite, 2 viti di ricambio e 1 chiave.

Serie / Series / Serie

C
Ø 11,1 mm – 12,95 mm
2 x D – 2,5 x D

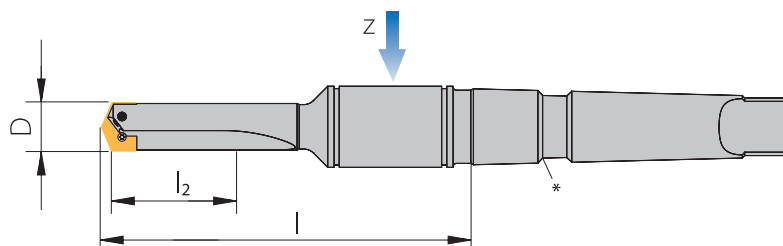

* Morsekegel (MK) nach DIN ISO 296
Taper shank (MK) to DIN ISO 296
Cono Morse (MK) secondo DIN ISO 296

Trägerwerkzeug / Drill holder / Corpo punta

Bezeichnung Designation Articolo	Bohrtiefe Drill depth Profondità foratura	D	l	l ₂	l ₃	d _A	z	MK
HC1110-1295-32GMK2	2 x D – 2,5 x D	11,1 – 12,95	88	32	-	-	2KDA	MK2

HINWEIS: Trägerwerkzeuge werden mit Klemmschrauben, 2 Ersatzschrauben und Schlüssel geliefert.
INFORMATION: Holders will be supplied with clamping screws, 2 spare screws and key.
NOTA: L'utensile é fornito completo di 1 vite, 2 viti di ricambio e 1 chiave.

Zubehör für Bohrer siehe Seite 94 – 95.

Hinweis: Beachten Sie bitte die Anwendungshinweise zu diesen Haltern ab Seite 109!

Holder accessories see page 94 – 95.

Remark: Please see the application guidelines for this holder on page 109!

Accessori corpo a pagina 94 – 95.

Attenzione: Note di utilizzo per questo tipo di utensile a pagina 109!

Alle Angaben in mm / Dimensions in mm / Tutte le dimensioni in mm

Schneidplatten-Bohrer mit Morsekegel

Taper shank holders
Corpo con Cono Morse

Serie / Series / Serie

C
Ø 11,1 mm – 12,95 mm
4,5 x D – 10 x D

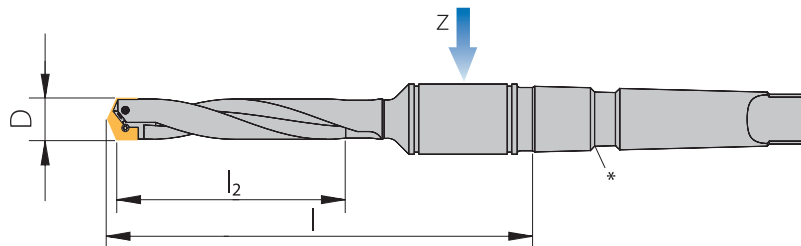

* Morsekegel (MK) nach DIN ISO 296
Taper shank (MK) to DIN ISO 296
Cono Morse (MK) secondo DIN ISO 296

Trägerwerkzeug / Drill holder / Corpo punta

Bezeichnung Designation Articolo	Bohrtiefe Drill depth Profondità foratura	D	l	l ₂	l ₃	d _A	z	MK
HC1110-1295-60SPMK2	4,5 x D – 5 x D	11,1 – 12,95	116,7	60	-	-	2KDA	MK2
HC1110-1295-111SPMK2	8,5 x D – 10 x D	11,1 – 12,95	167,4	111	-	-	2KDA	MK2

HINWEIS: Trägerwerkzeuge werden mit Klemmschrauben, 2 Ersatzschrauben und Schlüssel geliefert.
INFORMATION: Holders will be supplied with clamping screws, 2 spare screws and key.
NOTA: L'utensile é fornito completo di 1 vite, 2 viti di ricambio e 1 chiave.

Serie / Series / Serie

C
Ø 11,1 mm – 12,95 mm
8,5 x D – 10 x D

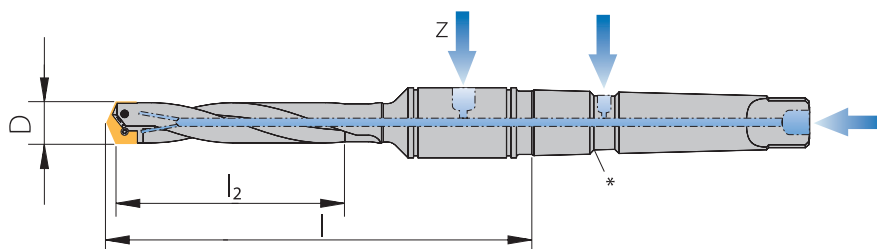

* Morsekegel (MK) nach DIN ISO 296
Taper shank (MK) to DIN ISO 296
Cono Morse (MK) secondo DIN ISO 296

Trägerwerkzeug / Drill holder / Corpo punta

Bezeichnung Designation Articolo	Bohrtiefe Drill depth Profondità foratura	D	l	l ₂	l ₃	d _A	z	MK
HC1110-1295-111SPMK2-G	8,5 x D – 10 x D	11,1 – 12,95	167,4	111	-	-	2KDA	MK2

HINWEIS: Trägerwerkzeuge werden mit Klemmschrauben, 2 Ersatzschrauben und Schlüssel geliefert.
INFORMATION: Holders will be supplied with clamping screws, 2 spare screws and key.
NOTA: L'utensile é fornito completo di 1 vite, 2 viti di ricambio e 1 chiave.

Zubehör für Bohrer siehe Seite 94 – 95.
Hinweis: Beachten Sie bitte die Anwendungshinweise zu diesen Haltern ab Seite 109!

Holder accessories see page 94 – 95.
Remark: Please see the application guidelines for this holder on page 109!

Accessori corpo a pagina 94 – 95.
Attenzione: Note di utilizzo per questo tipo di utensile a pagina 109!

Schneidplatten-Bohrer mit Morsekegel

Taper shank holders
Corpo con Cono Morse

Serie / Series / Serie

E

Ø 12,98 mm – 17,65 mm
1,5 x D – 2,5 x D

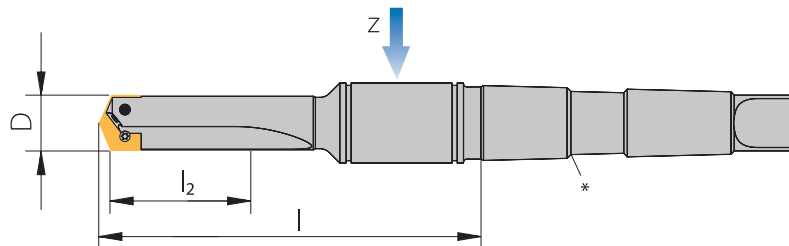

* Morsekegel (MK) nach DIN ISO 296
Taper shank (MK) to DIN ISO 296
Cono Morse (MK) secondo DIN ISO 296

Trägerwerkzeug / Drill holder / Corpo punta

Bezeichnung Designation Articolo	Bohrtiefe Drill depth Profondità foratura	D	l	l ₂	l ₃	d _A	z	MK
HE1298-1765-35GMK2	1,5 x D – 2,5 x D	12,98 – 17,65	92,4	35	-	-	2KDA	MK2

HINWEIS: Trägerwerkzeuge werden mit Klemmschrauben, 2 Ersatzschrauben und Schlüssel geliefert.
INFORMATION: Holders will be supplied with clamping screws, 2 spare screws and key.
NOTA: L'utensile é fornito completo di 1 vite, 2 viti di ricambio e 1 chiave.

Serie / Series / Serie

G

Ø 15,5 mm – 17,65 mm
1,5 x D – 2 x D

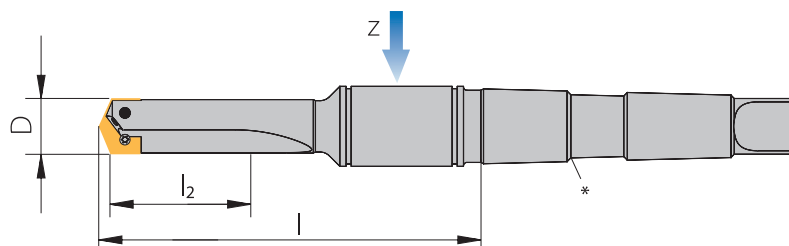

* Morsekegel (MK) nach DIN ISO 296
Taper shank (MK) to DIN ISO 296
Cono Morse (MK) secondo DIN ISO 296

Trägerwerkzeug / Drill holder / Corpo punta

Bezeichnung Designation Articolo	Bohrtiefe Drill depth Profondità foratura	D	l	l ₂	l ₃	d _A	z	MK
HG1550-1765-35GMK2	1,5 x D – 2 x D	15,5 – 17,65	92,4	35	-	-	2KDA	MK2

HINWEIS: Trägerwerkzeuge werden mit Klemmschrauben, 2 Ersatzschrauben und Schlüssel geliefert.
INFORMATION: Holders will be supplied with clamping screws, 2 spare screws and key.
NOTA: L'utensile é fornito completo di 1 vite, 2 viti di ricambio e 1 chiave.

Zubehör für Bohrer siehe Seite 94 – 95.

Hinweis: Beachten Sie bitte die Anwendungshinweise zu diesen Haltern ab Seite 109!

Holder accessories see page 94 – 95.

Remark: Please see the application guidelines for this holder on page 109!

Accessori corpo a pagina 94 – 95.

Attenzione: Note di utilizzo per questo tipo di utensile a pagina 109!

Alle Angaben in mm / Dimensions in mm / Tutte le dimensioni in mm

Schneidplatten-Bohrer mit Morsekegel

Taper shank holders
Corpo con Cono Morse

Serie / Series / Serie

E
Ø 12,98 mm – 17,65 mm
3,5 x D – 13,5 x D

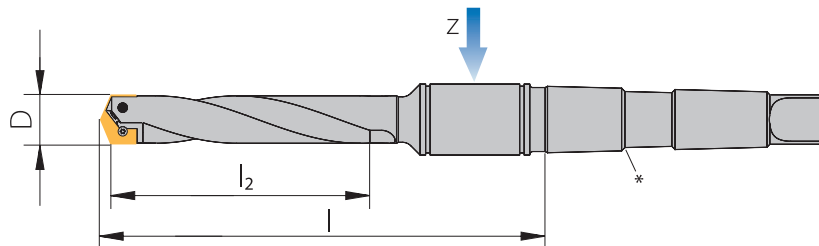

* Morsekegel (MK) nach DIN ISO 296
Taper shank (MK) to DIN ISO 296
Cono Morse (MK) secondo DIN ISO 296

Trägerwerkzeug / Drill holder / Corpo punta

Bezeichnung Designation Articolo	Bohrtiefe Drill depth Profondità foratura	D	l	l ₂	l ₃	d _A	z	MK
HE1298-1765-64SPMK2	3,5 x D – 4,5 x D	12,98 – 17,65	121	64	-	-	2KDA	MK2
HE1298-1765-114SPMK2	6 x D – 8,5 x D	12,98 – 17,65	171,8	114	-	-	2KDA	MK2
HE1298-1765-178SPMK2	10 x D – 13,5 x D	12,98 – 17,65	235,8	178	-	-	2KDA	MK2

HINWEIS: Trägerwerkzeuge werden mit Klemmschrauben, 2 Ersatzschrauben und Schlüssel geliefert.
INFORMATION: Holders will be supplied with clamping screws, 2 spare screws and key.
NOTA: L'utensile é fornito completo di 1 vite, 2 viti di ricambio e 1 chiave.

Serie / Series / Serie

G
Ø 15,5 mm – 17,65 mm
3,5 x D – 11 x D

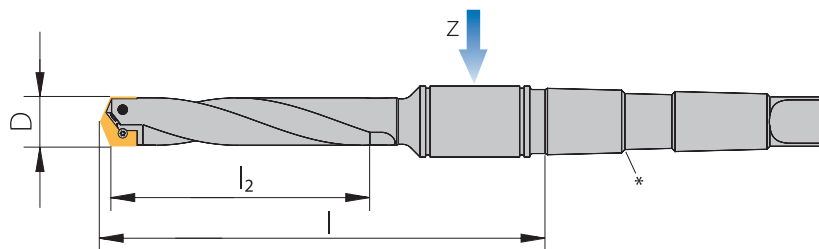

* Morsekegel (MK) nach DIN ISO 296
Taper shank (MK) to DIN ISO 296
Cono Morse (MK) secondo DIN ISO 296

Trägerwerkzeug / Drill holder / Corpo punta

Bezeichnung Designation Articolo	Bohrtiefe Drill depth Profondità foratura	D	l	l ₂	l ₃	d _A	z	MK
HG1550-1765-64SPMK2	3,5 x D – 4 x D	15,5 – 17,65	121	64	-	-	2KDA	MK2
HG1550-1765-114SPMK2	6 x D – 7 x D	15,5 – 17,65	171,8	114	-	-	2KDA	MK2
HG1550-1765-178SPMK2	10 x D – 11 x D	15,5 – 17,65	235,8	178	-	-	2KDA	MK2

HINWEIS: Trägerwerkzeuge werden mit Klemmschrauben, 2 Ersatzschrauben und Schlüssel geliefert.
INFORMATION: Holders will be supplied with clamping screws, 2 spare screws and key.
NOTA: L'utensile é fornito completo di 1 vite, 2 viti di ricambio e 1 chiave.

Zubehör für Bohrer siehe Seite 94 – 95.
Hinweis: Beachten Sie bitte die Anwendungshinweise zu diesen Haltern ab Seite 109!

Holder accessories see page 94 – 95.
Remark: Please see the application guidelines for this holder on page 109!

Accessori corpo a pagina 94 – 95.
Attenzione: Note di utilizzo per questo tipo di utensile a pagina 109!

Schneidplatten-Bohrer mit Morsekegel

Taper shank holders
Corpo con Cono Morse

Serie / Series / Serie

E
Ø 12,98 mm – 17,65 mm
6 x D – 8,5 x D

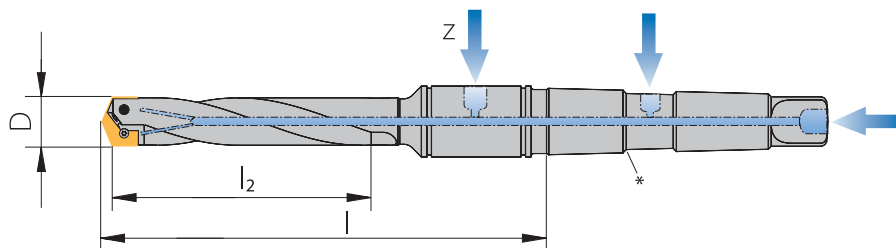

* Morsekegel (MK) nach DIN ISO 296
Taper shank (MK) to DIN ISO 296
Cono Morse (MK) secondo DIN ISO 296

Trägerwerkzeug / Drill holder / Corpo punta

Bezeichnung Designation Articolo	Bohrtiefe Drill depth Profondità foratura	D	l	l ₂	l ₃	d _A	z	MK
HE1298-1765-114SPMK2-G	6 x D – 8,5 x D	12,98 – 17,65	171,8	114	-	-	2KDA	MK2

HINWEIS: Trägerwerkzeuge werden mit Klemmschrauben, 2 Ersatzschrauben und Schlüssel geliefert.
INFORMATION: Holders will be supplied with clamping screws, 2 spare screws and key.
NOTA: L'utensile é fornito completo di 1 vite, 2 viti di ricambio e 1 chiave.

Serie / Series / Serie

I
Ø 17,53 mm – 24,38 mm
2,5 x D – 3,5 x D

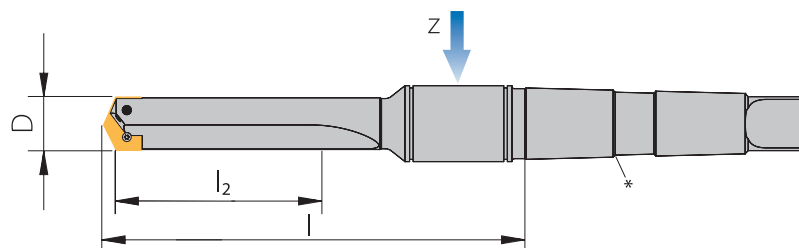

* Morsekegel (MK) nach DIN ISO 296
Taper shank (MK) to DIN ISO 296
Cono Morse (MK) secondo DIN ISO 296

Trägerwerkzeug / Drill holder / Corpo punta

Bezeichnung Designation Articolo	Bohrtiefe Drill depth Profondità foratura	D	l	l ₂	l ₃	d _A	z	MK
HI1753-2438-70GMK3	2,5 x D – 3,5 x D	17,53 – 24,38	142,5	70	-	-	3KDA	MK3

HINWEIS: Trägerwerkzeuge werden mit Klemmschrauben, 2 Ersatzschrauben und Schlüssel geliefert.
INFORMATION: Holders will be supplied with clamping screws, 2 spare screws and key.
NOTA: L'utensile é fornito completo di 1 vite, 2 viti di ricambio e 1 chiave.

Zubehör für Bohrer siehe Seite 94 – 95.

Hinweis: Beachten Sie bitte die Anwendungshinweise zu diesen Haltern ab Seite 109!

Holder accessories see page 94 – 95.

Remark: Please see the application guidelines for this holder on page 109!

Accessori corpo a pagina 94 – 95.

Attenzione: Note di utilizzo per questo tipo di utensile a pagina 109!

Schneidplatten-Bohrer mit Morsekegel

Taper shank holders
Corpo con Cono Morse

Serie / Series / Serie

K

Ø 22,0 mm – 24,38 mm
2,5 x D – 3 x D

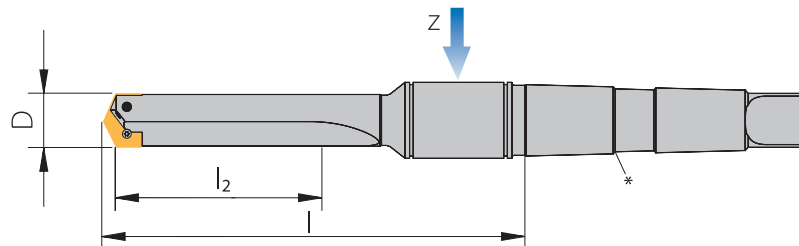

* Morsekegel (MK) nach DIN ISO 296
Taper shank (MK) to DIN ISO 296
Cono Morse (MK) secondo DIN ISO 296

Trägerwerkzeug / Drill holder / Corpo punta

Bezeichnung Designation Articolo	Bohrtiefe Drill depth Profondità foratura	D	l	l ₂	l ₃	d _A	z	MK
HK2200-2438-70GMK3	2,5 x D – 3 x D	22,0 – 24,38	142,5	70	-	-	3KDA	MK3

HINWEIS: Trägerwerkzeuge werden mit Klemmschrauben, 2 Ersatzschrauben und Schlüssel geliefert.
INFORMATION: Holders will be supplied with clamping screws, 2 spare screws and key.
NOTA: L'utensile é fornito completo di 1 vite, 2 viti di ricambio e 1 chiave.

Serie / Series / Serie

I

Ø 17,53 mm – 24,38 mm
4,5 x D – 15,5 x D

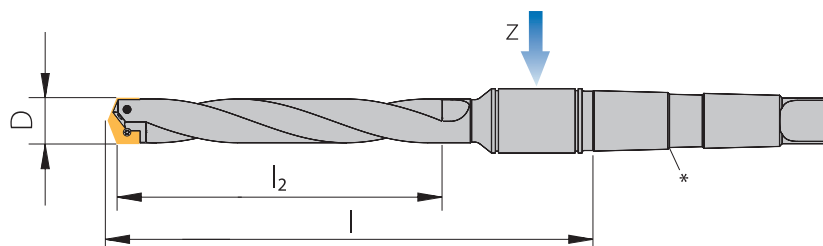

* Morsekegel (MK) nach DIN ISO 296
Taper shank (MK) to DIN ISO 296
Cono Morse (MK) secondo DIN ISO 296

Trägerwerkzeug / Drill holder / Corpo punta

Bezeichnung Designation Articolo	Bohrtiefe Drill depth Profondità foratura	D	l	l ₂	l ₃	d _A	z	MK
HI1753-2438-121SPMK3	4,5 x D – 6,5 x D	17,53 – 24,38	193,9	121	-	-	3KDA	MK3
HI1753-2438-172SPMK3	7 x D – 9,5 x D	17,53 – 24,38	244,1	172	-	-	3KDA	MK3
HI1753-2438-273SPMK3	11 x D – 15,5 x D	17,53 – 24,38	345,7	273	-	-	3KDA	MK3

HINWEIS: Trägerwerkzeuge werden mit Klemmschrauben, 2 Ersatzschrauben und Schlüssel geliefert.
INFORMATION: Holders will be supplied with clamping screws, 2 spare screws and key.
NOTA: L'utensile é fornito completo di 1 vite, 2 viti di ricambio e 1 chiave.

Zubehör für Bohrer siehe Seite 94 – 95.
Hinweis: Beachten Sie bitte die Anwendungshinweise zu diesen Haltern ab Seite 109!

Holder accessories see page 94 – 95.
Remark: Please see the application guidelines for this holder on page 109!

Accessori corpo a pagina 94 – 95.
Attenzione: Note di utilizzo per questo tipo di utensile a pagina 109!

Schneidplatten-Bohrer mit Morsekegel

Taper shank holders
Corpo con Cono Morse

Serie / Series / Serie

K

Ø 22,0 mm – 24,38 mm
4,5 x D – 12 x D

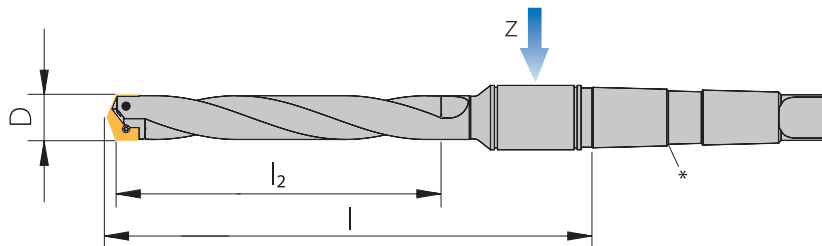

* Morsekegel (MK) nach DIN ISO 296
Taper shank (MK) to DIN ISO 296
Cono Morse (MK) secondo DIN ISO 296

Trägerwerkzeug / Drill holder / Corpo punta

Bezeichnung Designation Articolo	Bohrtiefe Drill depth Profondità foratura	D	l	l ₂	l ₃	d _A	z	MK
HK2200-2438-121SPMK3	4,5 x D – 5,5 x D	22,0 – 24,38	193,9	121	-	-	3KDA	MK3
HK2200-2438-172SPMK3	7 x D – 7,5 x D	22,0 – 24,38	244,1	172	-	-	3KDA	MK3
HK2200-2438-273SPMK3	11 x D – 12 x D	22,0 – 24,38	345,7	273	-	-	3KDA	MK3

HINWEIS: Trägerwerkzeuge werden mit Klemmschrauben, 2 Ersatzschrauben und Schlüssel geliefert.
INFORMATION: Holders will be supplied with clamping screws, 2 spare screws and key.
NOTA: L'utensile é fornito completo di 1 vite, 2 viti di ricambio e 1 chiave.

Serie / Series / Serie

I

Ø 17,53 mm – 24,38 mm
2,5 x D – 9,5 x D

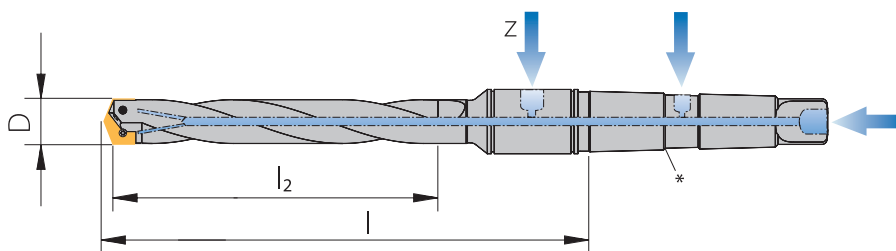

* Morsekegel (MK) nach DIN ISO 296
Taper shank (MK) to DIN ISO 296
Cono Morse (MK) secondo DIN ISO 296

Trägerwerkzeug / Drill holder / Corpo punta

Bezeichnung Designation Articolo	Bohrtiefe Drill depth Profondità foratura	D	l	l ₂	l ₃	d _A	z	MK
HI1753-2438-70GMK3-G	2,5 x D – 3,5 x D	17,53 – 24,38	142,5	70	-	-	3KDA	MK3
HI1753-2438-121SPMK3-G	4,5 x D – 6,5 x D	17,53 – 24,38	193,9	121	-	-	3KDA	MK3
HI1753-2438-172SPMK3-G	7 x D – 9,5 x D	17,53 – 24,38	244,1	172	-	-	3KDA	MK3

HINWEIS: Trägerwerkzeuge werden mit Klemmschrauben, 2 Ersatzschrauben und Schlüssel geliefert.
INFORMATION: Holders will be supplied with clamping screws, 2 spare screws and key.
NOTA: L'utensile é fornito completo di 1 vite, 2 viti di ricambio e 1 chiave.

Zubehör für Bohrer siehe Seite 94 – 95.

Hinweis: Beachten Sie bitte die Anwendungshinweise zu diesen Haltern ab Seite 109!

Holder accessories see page 94 – 95.

Remark: Please see the application guidelines for this holder on page 109!

Accessori corpo a pagina 94 – 95.

Attenzione: Note di utilizzo per questo tipo di utensile a pagina 109!

Schneidplatten-Bohrer mit Morsekegel

Taper shank holders
Corpo con Cono Morse

Serie / Series / Serie

K

Ø 22,0 mm – 24,38 mm
4,5 x D – 7,5 x D

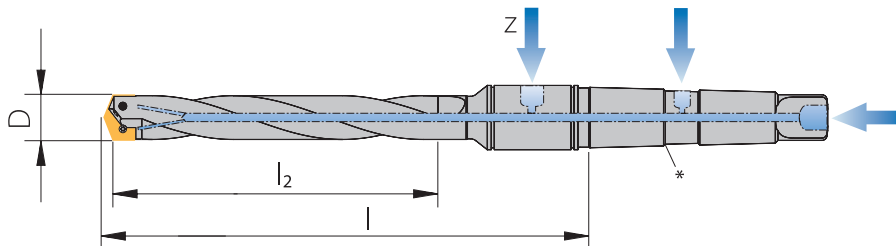

* Morsekegel (MK) nach DIN ISO 296
Taper shank (MK) to DIN ISO 297
Cono Morse (MK) secondo DIN ISO 297

Trägerwerkzeug / Drill holder / Corpo punta

Bezeichnung Designation Articolo	Bohrtiefe Drill depth Profondità foratura	D	l	l ₂	l ₃	d _A	z	MK
HK2200-2438-121SPMK3-G	4,5 x D – 5,5 x D	22,0 – 24,38	193,9	121	-	-	3KDA	MK3
HK2200-2438-172SPMK3-G	7 x D – 7,5 x D	22,0 – 24,38	244,1	172	-	-	3KDA	MK3

HINWEIS: Trägerwerkzeuge werden mit Klemmschrauben, 2 Ersatzschrauben und Schlüssel geliefert.
INFORMATION: Holders will be supplied with clamping screws, 2 spare screws and key.
NOTA: L'utensile é fornito completo di 1 vite, 2 viti di ricambio e 1 chiave.

Serie / Series / Serie

M

Ø 24,41 mm – 35,05 mm
2 x D – 3,5 x D

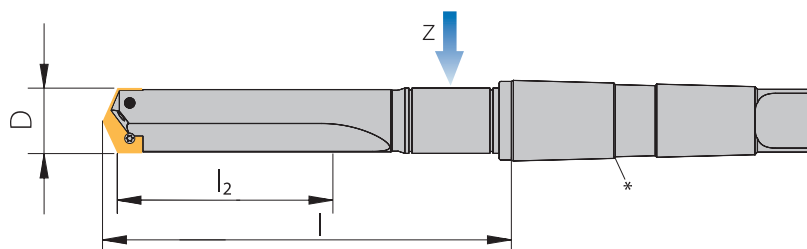

* Morsekegel (MK) nach DIN ISO 296
Taper shank (MK) to DIN ISO 296
Cono Morse (MK) secondo DIN ISO 296

Trägerwerkzeug / Drill holder / Corpo punta

Bezeichnung Designation Articolo	Bohrtiefe Drill depth Profondità foratura	D	l	l ₂	l ₃	d _A	z	MK
HM2441-3505-86GMK4	2 x D – 3,5 x D	24,41 – 35,05	160,4	86	-	-	3KDA	MK4

HINWEIS: Trägerwerkzeuge werden mit Klemmschrauben, 2 Ersatzschrauben und Schlüssel geliefert.
INFORMATION: Holders will be supplied with clamping screws, 2 spare screws and key.
NOTA: L'utensile é fornito completo di 1 vite, 2 viti di ricambio e 1 chiave.

Zubehör für Bohrer siehe Seite 94 – 95.
Hinweis: Beachten Sie bitte die Anwendungshinweise zu diesen Haltern ab Seite 109!

Holder accessories see page 94 – 95.
Remark: Please see the application guidelines for this holder on page 109!

Accessori corpo a pagina 94 – 95.
Attenzione: Note di utilizzo per questo tipo di utensile a pagina 109!

Schneidplatten-Bohrer mit Morsekegel

Taper shank holders
Corpo con Cono Morse

Serie / Series / Serie

O

Ø 30,0 mm – 35,05 mm
2 x D – 3,5 x D

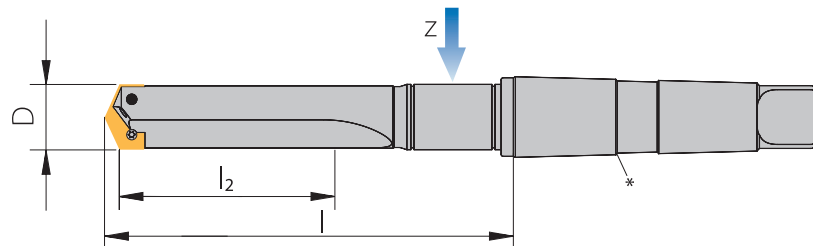

* Morsekegel (MK) nach DIN ISO 296
Taper shank (MK) to DIN ISO 296
Cono Morse (MK) secondo DIN ISO 296

Trägerwerkzeug / Drill holder / Corpo punta

Bezeichnung Designation Articolo	Bohrtiefe Drill depth Profondità foratura	D	l	l ₂	l ₃	d _A	z	MK
HO3000-3505-86GMK4	2 x D – 3,5 x D	30,0 – 35,05	167,6	86	-	-	4KDA	MK4

HINWEIS: Trägerwerkzeuge werden mit Klemmschrauben, 2 Ersatzschrauben und Schlüssel geliefert.
INFORMATION: Holders will be supplied with clamping screws, 2 spare screws and key.
NOTA: L'utensile é fornito completo di 1 vite, 2 viti di ricambio e 1 chiave.

Serie / Series / Serie

M

Ø 24,41 mm – 35,05 mm
3,5 x D – 11,5 x D

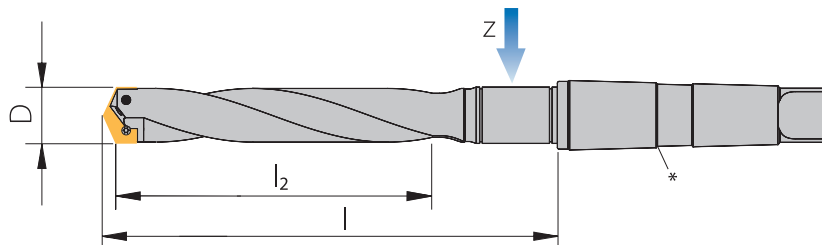

* Morsekegel (MK) nach DIN ISO 296
Taper shank (MK) to DIN ISO 296
Cono Morse (MK) secondo DIN ISO 296

Trägerwerkzeug / Drill holder / Corpo punta

Bezeichnung Designation Articolo	Bohrtiefe Drill depth Profondità foratura	D	l	l ₂	l ₃	d _A	z	MK
HM2441-3505-137SPMK4	3,5 x D – 5,5 x D	24,41 – 35,05	211,2	137	-	-	3KDA	MK4
HM2441-3505-188SPMK4	5 x D – 7,5 x D	24,41 – 35,05	262	188	-	-	3KDA	MK4
HM2441-3505-289SPMK4	8 x D – 11,5 x D	24,41 – 35,05	363,6	289	-	-	3KDA	MK4

HINWEIS: Trägerwerkzeuge werden mit Klemmschrauben, 2 Ersatzschrauben und Schlüssel geliefert.
INFORMATION: Holders will be supplied with clamping screws, 2 spare screws and key.
NOTA: L'utensile é fornito completo di 1 vite, 2 viti di ricambio e 1 chiave.

Zubehör für Bohrer siehe Seite 94 – 95.

Hinweis: Beachten Sie bitte die Anwendungshinweise zu diesen Haltern ab Seite 109!

Holder accessories see page 94 – 95.

Remark: Please see the application guidelines for this holder on page 109!

Accessori corpo a pagina 94 – 95.

Attenzione: Note di utilizzo per questo tipo di utensile a pagina 109!

Schneidplatten-Bohrer mit Morsekegel

Taper shank holders
Corpo con Cono Morse

Serie / Series / Serie

O

Ø 30,0 mm – 35,05 mm
3,5 x D – 11,5 x D

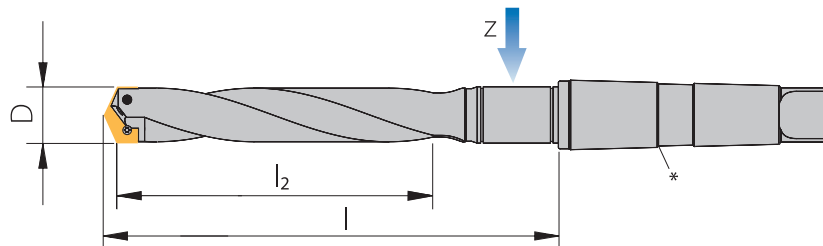

* Morsekegel (MK) nach DIN ISO 296
Taper shank (MK) to DIN ISO 296
Cono Morse (MK) secondo DIN ISO 296

Trägerwerkzeug / Drill holder / Corpo punta

Bezeichnung Designation Articolo	Bohrtiefe Drill depth Profondità foratura	D	l	l ₂	l ₃	d _A	z	MK
HO3000-3505-137SPMK4	3,5 x D – 5,5 x D	30,0 – 35,05	218,4	137	-	-	4KDA	MK4
HO3000-3505-188SPMK4	5 x D – 7,5 x D	30,0 – 35,05	269,4	188	-	-	4KDA	MK4
HO3000-3505-289SPMK4	8 x D – 11,5 x D	30,0 – 35,05	370,8	289	-	-	4KDA	MK4

HINWEIS: Trägerwerkzeuge werden mit Klemmschrauben, 2 Ersatzschrauben und Schlüssel geliefert.
INFORMATION: Holders will be supplied with clamping screws, 2 spare screws and key.
NOTA: L'utensile é fornito completo di 1 vite, 2 viti di ricambio e 1 chiave.

Serie / Series / Serie

M

Ø 24,41 mm – 35,05 mm
2 x D – 7,5 x D

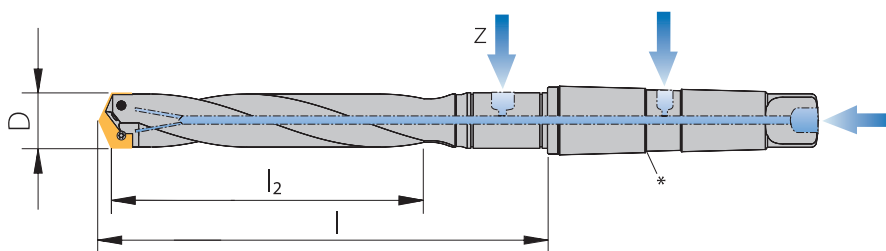

* Morsekegel (MK) nach DIN ISO 296
Taper shank (MK) to DIN ISO 296
Cono Morse (MK) secondo DIN ISO 296

Trägerwerkzeug / Drill holder / Corpo punta

Bezeichnung Designation Articolo	Bohrtiefe Drill depth Profondità foratura	D	l	l ₂	l ₃	d _A	z	MK
HM2441-3505-86GMK4-G	2 x D – 3,5 x D	24,41 – 35,05	160,4	86	-	-	3KDA	MK4
HM2441-3505-137SPMK4-G	3,5 x D – 5,5 x D	24,41 – 35,05	211,2	137	-	-	3KDA	MK4
HM2441-3505-188SPMK4-G	5 x D – 7,5 x D	24,41 – 35,05	262	188	-	-	3KDA	MK4

HINWEIS: Trägerwerkzeuge werden mit Klemmschrauben, 2 Ersatzschrauben und Schlüssel geliefert.
INFORMATION: Holders will be supplied with clamping screws, 2 spare screws and key.
NOTA: L'utensile é fornito completo di 1 vite, 2 viti di ricambio e 1 chiave.

Zubehör für Bohrer siehe Seite 94 – 95.
Hinweis: Beachten Sie bitte die Anwendungshinweise zu diesen Haltern ab Seite 109!

Holder accessories see page 94 – 95.
Remark: Please see the application guidelines for this holder on page 109!

Accessori corpo a pagina 94 – 95.
Attenzione: Note di utilizzo per questo tipo di utensile a pagina 109!

Schneidplatten-Bohrer mit Morsekegel

Taper shank holders
Corpo con Cono Morse

Serie / Series / Serie

Q

Ø 34,37 mm – 47,8 mm
2,5 x D – 3,5 x D

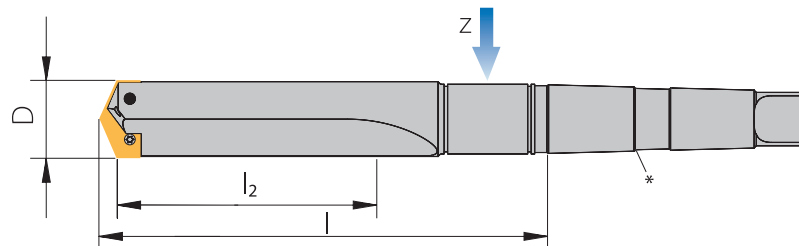

* Morsekegel (MK) nach DIN ISO 296
Taper shank (MK) to DIN ISO 296
Cono Morse (MK) secondo DIN ISO 296

Trägerwerkzeug / Drill holder / Corpo punta

Bezeichnung Designation Articolo	Bohrtiefe Drill depth Profondità foratura	D	l	l ₂	l ₃	d _A	z	MK
HQ3437-4780-121GMK4	2,5 x D – 3,5 x D	34,37 – 47,8	206,4	121	-	-	4KDA	MK4

HINWEIS: Trägerwerkzeuge werden mit Klemmschrauben, 2 Ersatzschrauben und Schlüssel geliefert.
INFORMATION: Holders will be supplied with clamping screws, 2 spare screws and key.
NOTA: L'utensile é fornito completo di 1 vite, 2 viti di ricambio e 1 chiave.

Serie / Series / Serie

Q

Ø 34,37 mm – 47,8 mm
3 x D – 6 x D

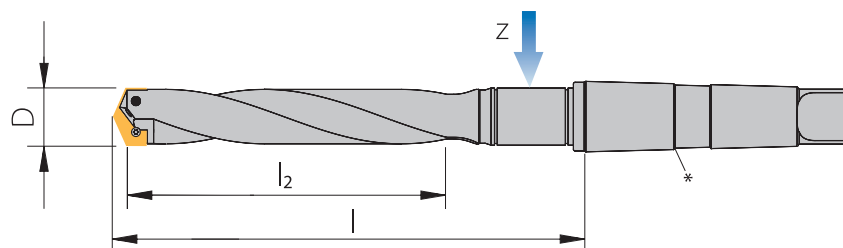

* Morsekegel (MK) nach DIN ISO 296
Taper shank (MK) to DIN ISO 296
Cono Morse (MK) secondo DIN ISO 296

Trägerwerkzeug / Drill holder / Corpo punta

Bezeichnung Designation Articolo	Bohrtiefe Drill depth Profondità foratura	D	l	l ₂	l ₃	d _A	z	MK
HQ3437-4780-165SPMK4	3 x D – 4,5 x D	34,37 – 47,8	250,9	165	-	-	4KDA	MK4
HQ3437-4780-210SPMK4	4 x D – 6 x D	34,37 – 47,8	295,3	210	-	-	4KDA	MK4

HINWEIS: Trägerwerkzeuge werden mit Klemmschrauben, 2 Ersatzschrauben und Schlüssel geliefert.
INFORMATION: Holders will be supplied with clamping screws, 2 spare screws and key.
NOTA: L'utensile é fornito completo di 1 vite, 2 viti di ricambio e 1 chiave.

Zubehör für Bohrer siehe Seite 94 – 95.

Hinweis: Beachten Sie bitte die Anwendungshinweise zu diesen Haltern ab Seite 109!

Holder accessories see page 94 – 95.

Remark: Please see the application guidelines for this holder on page 109!

Accessori corpo a pagina 94 – 95.

Attenzione: Note di utilizzo per questo tipo di utensile a pagina 109!

Schneidplatten-Bohrer mit Morsekegel

Taper shank holders
Corpo con Cono Morse

Serie / Series / Serie

Q

Ø 34,37 mm – 47,8 mm
7 x D – 22,5 x D

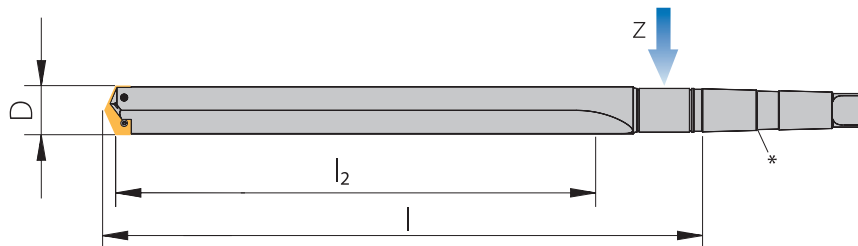

* Morsekegel (MK) nach DIN ISO 296
Taper shank (MK) to DIN ISO 296
Cono Morse (MK) secondo DIN ISO 296

Trägerwerkzeug / Drill holder / Corpo punta

Bezeichnung Designation Articolo	Bohrtiefe Drill depth Profondità foratura	D	l	l ₂	l ₃	d _A	z	MK
HQ3437-4780-349GMK4	7 x D – 10 x D	34,37 – 47,8	435	349	-	-	4KDA	MK4
HQ3437-4780-558GMK4	11,5 x D – 16 x D	34,37 – 47,8	644,6	558	-	-	4KDA	MK4
HQ3437-4780-787GMK4	16 x D – 22,5 x D	34,37 – 47,8	873,2	787	-	-	4KDA	MK4

HINWEIS: Trägerwerkzeuge werden mit Klemmschrauben, 2 Ersatzschrauben und Schlüssel geliefert.
INFORMATION: Holders will be supplied with clamping screws, 2 spare screws and key.
NOTA: L'utensile é fornito completo di 1 vite, 2 viti di ricambio e 1 chiave.

Serie / Series / Serie

Q

Ø 34,37 mm – 47,8 mm
3 x D – 4,5 x D

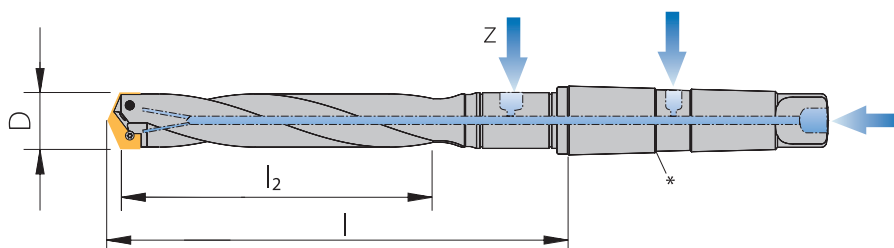

* Morsekegel (MK) nach DIN ISO 296
Taper shank (MK) to DIN ISO 296
Cono Morse (MK) secondo DIN ISO 296

Trägerwerkzeug / Drill holder / Corpo punta

Bezeichnung Designation Articolo	Bohrtiefe Drill depth Profondità foratura	D	l	l ₂	l ₃	d _A	z	MK
HQ3437-4780-165SPMK4-G	3 x D – 4,5 x D	34,37 – 47,8	250,9	165	-	-	4KDA	MK4

HINWEIS: Trägerwerkzeuge werden mit Klemmschrauben, 2 Ersatzschrauben und Schlüssel geliefert.
INFORMATION: Holders will be supplied with clamping screws, 2 spare screws and key.
NOTA: L'utensile é fornito completo di 1 vite, 2 viti di ricambio e 1 chiave.

Zubehör für Bohrer siehe Seite 94 – 95.
Hinweis: Beachten Sie bitte die Anwendungshinweise zu diesen Haltern ab Seite 109!

Holder accessories see page 94 – 95.
Remark: Please see the application guidelines for this holder on page 109!

Accessori corpo a pagina 94 – 95.
Attenzione: Note di utilizzo per questo tipo di utensile a pagina 109!

Schneidplatten-Bohrer mit Morsekegel

Taper shank holders
Corpo con Cono Morse

Serie / Series / Serie

S
Ø 46,99 mm – 65,28 mm
1,5 x D – 2,5 x D

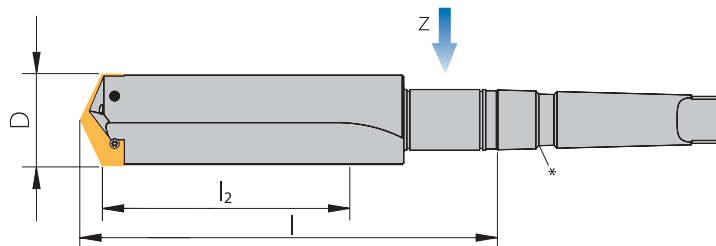

* Morsekegel (MK) nach DIN ISO 296
Taper shank (MK) to DIN ISO 296
Cono Morse (MK) secondo DIN ISO 296

1

Trägerwerkzeug / Drill holder / Corpo punta

Bezeichnung Designation Articolo	Bohrtiefe Drill depth Profondità foratura	D	l	l ₂	l ₃	d _A	z	MK
HS4699-6528-130GMK5	1,5 x D – 2,5 x D	46,99 – 65,28	219,1	130	-	-	5KDA	MK5

HINWEIS: Trägerwerkzeuge werden mit Klemmschrauben, 2 Ersatzschrauben und Schlüssel geliefert.
INFORMATION: Holders will be supplied with clamping screws, 2 spare screws and key.
NOTA: L'utensile é fornito completo di 1 vite, 2 viti di ricambio e 1 chiave.

Serie / Series / Serie

S
Ø 46,99 mm – 65,28 mm
3,5 x D – 4,5 x D

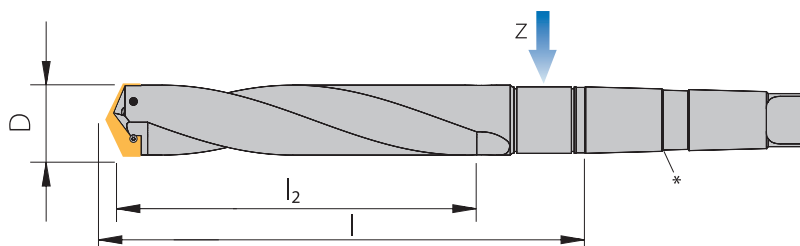

* Morsekegel (MK) nach DIN ISO 296
Taper shank (MK) to DIN ISO 296
Cono Morse (MK) secondo DIN ISO 296

Trägerwerkzeug / Drill holder / Corpo punta

Bezeichnung Designation Articolo	Bohrtiefe Drill depth Profondità foratura	D	l	l ₂	l ₃	d _A	z	MK
HS4699-6528-232SPMK5	3,5 x D – 4,5 x D	46,99 – 65,28	320,7	232	-	-	5KDA	MK5

HINWEIS: Trägerwerkzeuge werden mit Klemmschrauben, 2 Ersatzschrauben und Schlüssel geliefert.
INFORMATION: Holders will be supplied with clamping screws, 2 spare screws and key.
NOTA: L'utensile é fornito completo di 1 vite, 2 viti di ricambio e 1 chiave.

Zubehör für Bohrer siehe Seite 94 – 95.

Hinweis: Beachten Sie bitte die Anwendungshinweise zu diesen Haltern ab Seite 109!

Holder accessories see page 94 – 95.

Remark: Please see the application guidelines for this holder on page 109!

Accessori corpo a pagina 94 – 95.

Attenzione: Note di utilizzo per questo tipo di utensile a pagina 109!

Schneidplatten-Bohrer mit Morsekegel

Taper shank holders
Corpo con Cono Morse

Serie / Series / Serie

S
Ø 46,99 mm – 65,28 mm
6 x D – 18 x D

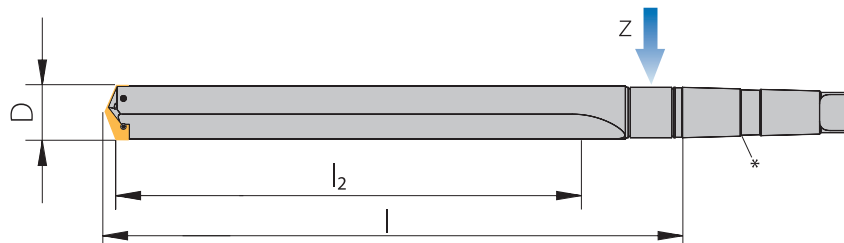

* Morsekegel (MK) nach DIN ISO 296
Taper shank (MK) to DIN ISO 296
Cono Morse (MK) secondo DIN ISO 296

Trägerwerkzeug / Drill holder / Corpo punta

Bezeichnung Designation Articolo	Bohrtiefe Drill depth Profondità foratura	D	l	l ₂	l ₃	d _A	z	MK
HS4699-6528-422GMK5	6 x D – 8,5 x D	46,99 – 65,28	511,2	422	-	-	5KDA	MK5
HS4699-6528-625GMK5	9,5 x D – 13 x D	46,99 – 65,28	714,4	625	-	-	5KDA	MK5
HS4699-6528-879GMK5	13 x D – 18,5 x D	46,99 – 65,28	968,4	879	-	-	5KDA	MK5

HINWEIS: Trägerwerkzeuge werden mit Klemmschrauben, 2 Ersatzschrauben und Schlüssel geliefert.
INFORMATION: Holders will be supplied with clamping screws, 2 spare screws and key.
NOTA: L'utensile é fornito completo di 1 vite, 2 viti di ricambio e 1 chiave.

Serie / Series / Serie

U
Ø 62,38 mm – 89,08 mm
1,5 x D – 2,5 x D

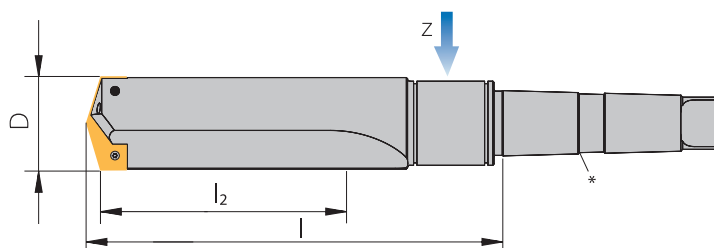

* Morsekegel (MK) nach DIN ISO 296
Taper shank (MK) to DIN ISO 296
Cono Morse (MK) secondo DIN ISO 296

Trägerwerkzeug / Drill holder / Corpo punta

Bezeichnung Designation Articolo	Bohrtiefe Drill depth Profondità foratura	D	l	l ₂	l ₃	d _A	z	MK
HU6238-8908-172GMK5	1,5 x D – 2,5 x D	62,38 – 89,08	287,3	172	-	-	6KDA	MK5

HINWEIS: Trägerwerkzeuge werden mit Klemmschrauben, 2 Ersatzschrauben und Schlüssel geliefert.
INFORMATION: Holders will be supplied with clamping screws, 2 spare screws and key.
NOTA: L'utensile é fornito completo di 1 vite, 2 viti di ricambio e 1 chiave.

Zubehör für Bohrer siehe Seite 94 – 95.
Hinweis: Beachten Sie bitte die Anwendungshinweise zu diesen Haltern ab Seite 109!

Holder accessories see page 94 – 95.
Remark: Please see the application guidelines for this holder on page 109!

Accessori corpo a pagina 94 – 95.
Attenzione: Note di utilizzo per questo tipo di utensile a pagina 109!

Schneidplatten-Bohrer mit Morsekegel

Taper shank holders
Corpo con Cono Morse

Serie / Series / Serie

U

Ø 62,38 mm – 89,08 mm
3 x D – 4 x D

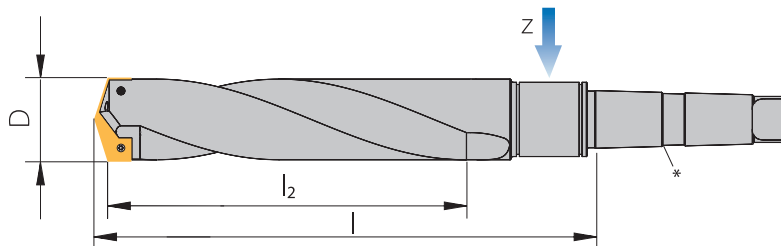

* Morsekegel (MK) nach DIN ISO 296
Taper shank (MK) to DIN ISO 296
Cono Morse (MK) secondo DIN ISO 296

Trägerwerkzeug / Drill holder / Corpo punta

Bezeichnung Designation Articolo	Bohrtiefe Drill depth Profondità foratura	D	l	l ₂	l ₃	d _A	z	MK
HU6238-8908-273SPMK5	3 x D – 4 x D	62,38 – 89,08	388,9	273	-	-	6KDA	MK5

HINWEIS: Trägerwerkzeuge werden mit Klemmschrauben, 2 Ersatzschrauben und Schlüssel geliefert.
INFORMATION: Holders will be supplied with clamping screws, 2 spare screws and key.
NOTA: L'utensile é fornito completo di 1 vite, 2 viti di ricambio e 1 chiave.

Serie / Series / Serie

U

Ø 62,38 mm – 89,08 mm
5 x D – 14 x D

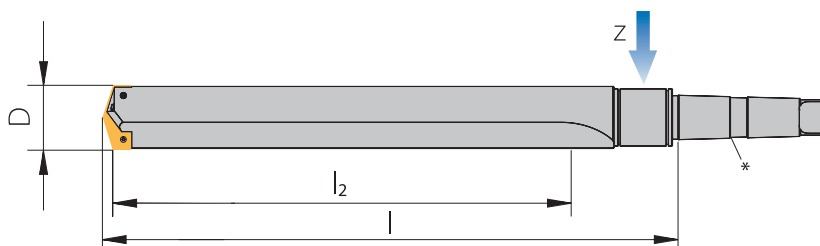

* Morsekegel (MK) nach DIN ISO 296
Taper shank (MK) to DIN ISO 296
Cono Morse (MK) secondo DIN ISO 296

Trägerwerkzeug / Drill holder / Corpo punta

Bezeichnung Designation Articolo	Bohrtiefe Drill depth Profondità foratura	D	l	l ₂	l ₃	d _A	z	MK
HU6238-8908-464GMK5	5 x D – 7 x D	62,38 – 89,08	579,4	464	-	-	6KDA	MK5
HU6238-8908-660GMK5	7 x D – 10,5 x D	62,38 – 89,08	776,2	660	-	-	6KDA	MK5
HU6238-8908-889GMK5	9,5 x D – 14 x D	62,38 – 89,08	1004,8	889	-	-	6KDA	MK5

HINWEIS: Trägerwerkzeuge werden mit Klemmschrauben, 2 Ersatzschrauben und Schlüssel geliefert.
INFORMATION: Holders will be supplied with clamping screws, 2 spare screws and key.
NOTA: L'utensile é fornito completo di 1 vite, 2 viti di ricambio e 1 chiave.

Zubehör für Bohrer siehe Seite 94 – 95.

Hinweis: Beachten Sie bitte die Anwendungshinweise zu diesen Haltern ab Seite 109!

Holder accessories see page 94 – 95.

Remark: Please see the application guidelines for this holder on page 109!

Accessori corpo a pagina 94 – 95.

Attenzione: Note di utilizzo per questo tipo di utensile a pagina 109!

Schneidplatten-Bohrer mit Morsekegel

Taper shank holders
Corpo con Cono Morse

Serie / Series / Serie

W

Ø 87,76 mm – 114,48 mm
1,5 x D – 2 x D

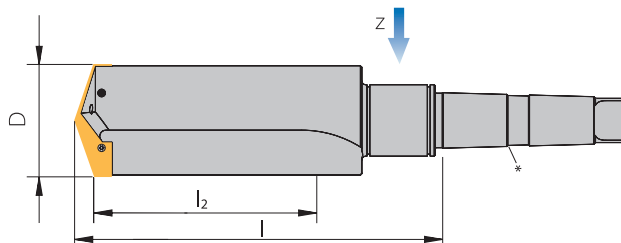

* Morsekegel (MK) nach DIN ISO 296
Taper shank (MK) to DIN ISO 296
Cono Morse (MK) secondo DIN ISO 296

Trägerwerkzeug / Drill holder / Corpo punta

Bezeichnung Designation Articolo	Bohrtiefe Drill depth Profondità foratura	D	l	l ₂	l ₃	d _A	z	MK
HW8776-11400-172GMK5	1,5 x D – 2 x D	87,76 – 114,48	296,8	172	-	-	6KDA	MK5

HINWEIS: Trägerwerkzeuge werden mit Klemmschrauben, 2 Ersatzschrauben und Schlüssel geliefert.
INFORMATION: Holders will be supplied with clamping screws, 2 spare screws and key.
NOTA: L'utensile é fornito completo di 1 vite, 2 viti di ricambio e 1 chiave.

Serie / Series / Serie

W

Ø 87,76 mm – 114,48 mm
2 x D – 3 x D

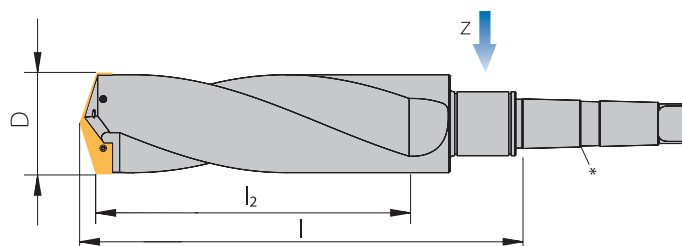

* Morsekegel (MK) nach DIN ISO 296
Taper shank (MK) to DIN ISO 296
Cono Morse (MK) secondo DIN ISO 296

Trägerwerkzeug / Drill holder / Corpo punta

Bezeichnung Designation Articolo	Bohrtiefe Drill depth Profondità foratura	D	l	l ₂	l ₃	d _A	z	MK
HW8776-11400-273SPMK5	2 x D – 3 x D	87,76 – 114,48	398,5	273	-	-	6KDA	MK5

HINWEIS: Trägerwerkzeuge werden mit Klemmschrauben, 2 Ersatzschrauben und Schlüssel geliefert.
INFORMATION: Holders will be supplied with clamping screws, 2 spare screws and key.
NOTA: L'utensile é fornito completo di 1 vite, 2 viti di ricambio e 1 chiave.

Zubehör für Bohrer siehe Seite 94 – 95.
Hinweis: Beachten Sie bitte die Anwendungshinweise zu diesen Haltern ab Seite 109!

Holder accessories see page 94 – 95.
Remark: Please see the application guidelines for this holder on page 109!

Accessori corpo a pagina 94 – 95.
Attenzione: Note di utilizzo per questo tipo di utensile a pagina 109!

Schneidplatten-Bohrer mit Morsekegel

Taper shank holders
Corpo con Cono Morse

Serie / Series / Serie

W

Ø 87,76 mm – 114,48 mm

4,5 x D – 10,5 x D

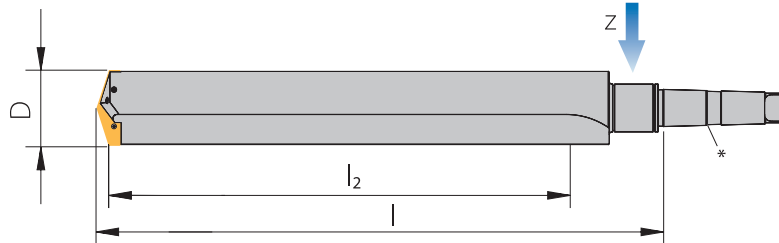

* Morsekegel (MK) nach DIN ISO 296
Taper shank (MK) to DIN ISO 296
Cono Morse (MK) secondo DIN ISO 296

1

Trägerwerkzeug / Drill holder / Corpo punta

Bezeichnung Designation Articolo	Bohrtiefe Drill depth Profondità foratura	D	l	l ₂	l ₃	d _A	z	MK
HW8776-11400-556GMK5	4,5 x D – 6 x D	87,76 – 114,48	681	556	-	-	6KDA	MK5
HW8776-11400-685GMK5	6 x D – 7,5 x D	87,76 – 114,48	811,2	685	-	-	6KDA	MK5
HW8776-11400-939GMK5	8 x D – 10,5 x D	87,76 – 114,48	1065,2	939	-	-	6KDA	MK5

HINWEIS: Trägerwerkzeuge werden mit Klemmschrauben, 2 Ersatzschrauben und Schlüssel geliefert.

INFORMATION: Holders will be supplied with clamping screws, 2 spare screws and key.

NOTA: L'utensile é fornito completo di 1 vite, 2 viti di ricambio e 1 chiave.

Zubehör für Bohrer siehe Seite 94 – 95.

Hinweis: Beachten Sie bitte die Anwendungshinweise zu diesen Haltern ab Seite 109!

Holder accessories see page 94 – 95.

Remark: Please see the application guidelines for this holder on page 109!

Accessori corpo a pagina 94 – 95.

Attenzione: Note di utilizzo per questo tipo di utensile a pagina 109!

Serie/Series/Serie **A**

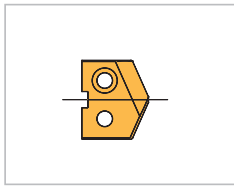

Seite
Page
Pagina **75 – 76**

Lieferbar in den Durchmessern von 9,5 mm bis 11 mm und den Sorten HSS5, HSS8, AK10, AK20 und AP40. Unbeschichtet und beschichtet (TiCN und TiAlN) erhältlich. Weitere Durchmesser, Sorten und Beschichtungen auf Anfrage.

Available in diameter 9.5 mm up to 11 mm. Grades HSS5, HSS8, AK10, AK20 and AP40. Uncoated and coated (TiCN and TiAlN). Other diameters, grades and coatings on request.

Disponibile da diametro 9,5 mm a diametro 11 mm. Gradi HSS5, HSS8, AK10, AK20 e AP40. Rivestiti e non rivestiti (TiCN e TiAlN). Diametri, gradi e rivestimenti diversi da quelli a catalogo disponibili su richiesta.

Serie/Series/Serie **C**

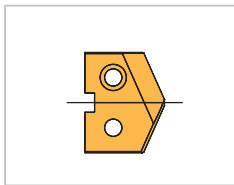

Seite
Page
Pagina **76 – 77**

Lieferbar in den Durchmessern von 11,5 mm bis 12,8 mm und den Sorten HSS5, HSS8, AK10, AK20 und AP40. Unbeschichtet und beschichtet (TiCN und TiAlN) erhältlich. Weitere Durchmesser, Sorten und Beschichtungen auf Anfrage.

Available in diameter 11.5 mm up to 12.8 mm. Grades HSS5, HSS8, AK10, AK20 and AP40. Uncoated and coated (TiCN and TiAlN). Other diameters, grades and coatings on request.

Disponibile da diametro 11,5 mm a diametro 12,8 mm. Gradi HSS5, HSS8, AK10, AK20 e AP40. Rivestiti e non rivestiti (TiCN e TiAlN). Diametri, gradi e rivestimenti diversi da quelli a catalogo disponibili su richiesta.

Serie/Series/Serie **E+G**

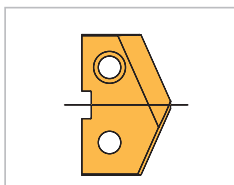

Seite
Page
Pagina **78 – 80**

Lieferbar in den Durchmessern von 13 mm bis 17,5 mm und den Sorten HSS5, HSS8, AK10, AK20 und AP40. Unbeschichtet und beschichtet (TiCN und TiAlN) erhältlich. Weitere Durchmesser, Sorten und Beschichtungen auf Anfrage.

Available in diameter 13 mm up to 17.5 mm. Grades HSS5, HSS8, AK10, AK20 and AP40. Uncoated and coated (TiCN and TiAlN). Other diameters, grades and coatings on request.

Disponibile da diametro 13 mm a diametro 17,5 mm. Gradi HSS5, HSS8, AK10, AK20 e AP40. Rivestiti e non rivestiti (TiCN e TiAlN). Diametri, gradi e rivestimenti diversi da quelli a catalogo disponibili su richiesta.

Serie/Series/Serie **I+K**

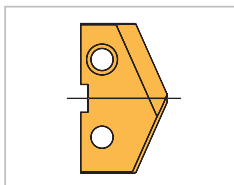

Seite
Page
Pagina **81 – 83**

Lieferbar in den Durchmessern von 17,8 mm bis 24 mm und den Sorten HSS, HSS5, HSS8, AK10, AK20 und AP40. Unbeschichtet und beschichtet (TiCN und TiAlN) erhältlich. Weitere Durchmesser, Sorten und Beschichtungen auf Anfrage.

Available in diameter 17.8 mm up to 24 mm. Grades HSS, HSS5, HSS8, AK10, AK20 and AP40. Uncoated and coated (TiCN and TiAlN). Other diameters, grades and coatings on request.

Disponibile da diametro 17,8 mm a diametro 24 mm. Gradi HSS, HSS5, HSS8, AK10, AK20 e AP40. Rivestiti e non rivestiti (TiCN e TiAlN). Diametri, gradi e rivestimenti diversi da quelli a catalogo disponibili su richiesta.

Serie/Series/Serie **M+O**

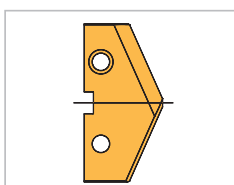

Seite
Page
Pagina **84 – 87**

Lieferbar in den Durchmessern von 24,5 mm bis 35 mm und den Sorten HSS, HSS5, HSS8, AK10, AK20 und AP40. Unbeschichtet und beschichtet (TiCN und TiAlN) erhältlich. Weitere Durchmesser, Sorten und Beschichtungen auf Anfrage.

Available in diameter 24.5 mm up to 35 mm. Grades HSS, HSS5, HSS8, AK10, AK20 and AP40. Uncoated and coated (TiCN and TiAlN). Other diameters, grades and coatings on request.

Disponibile da diametro 24,5 mm a diametro 35 mm. Gradi HSS, HSS5, HSS8, AK10, AK20 e AP40. Rivestiti e non rivestiti (TiCN e TiAlN). Diametri, gradi e rivestimenti diversi da quelli a catalogo disponibili su richiesta.

Serie/Series/Serie **Q**

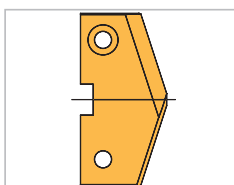

Seite
Page
Pagina **88 – 89**

Lieferbar in den Durchmessern von 36 mm bis 47 mm und den Sorten HSS, HSS5, AK20 und AP40. TiAlN beschichtet. Weitere Durchmesser, Sorten und Beschichtungen auf Anfrage.

Available in diameter 36 mm up to 47 mm. Grades HSS, HSS5, AK20 and AP40. TiAlN coated. Other diameters, grades and coatings on request.

Disponibile da diametro 36 mm a diametro 47 mm. Gradi HSS, HSS5, AK20 e AP40. Rivestiti TiAlN. Diametri, gradi e rivestimenti diversi da quelli a catalogo disponibili su richiesta.

Serie/Series/Serie **S**

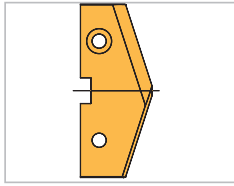

Seite
Page
Pagina **90 – 91**

Lieferbar in den Durchmessern von 48 mm bis 65 mm und den Sorten HSS und HSS5. TiAIN beschichtet. Weitere Durchmesser, Sorten und Beschichtungen auf Anfrage.

Available in diameter 48 mm up to 65 mm. Grades HSS and HSS5. TiAIN coated. Other diameters, grades and coatings on request.

Disponibile da diametro 48 mm a diametro 65 mm. Gradi HSS e HSS5. Rivestiti TiAIN. Diametri, gradi e rivestimenti diversi da quelli a catalogo disponibili su richiesta.

Serie/Series/Serie **U**

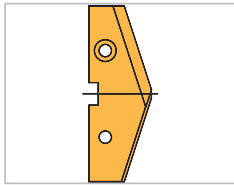

Seite
Page
Pagina **92**

Lieferbar in den Durchmessern von 66 mm bis 89 mm und den Sorten HSS und HSS5. TiAIN beschichtet. Weitere Durchmesser, Sorten und Beschichtungen auf Anfrage.

Available in diameter 66 mm up to 89 mm. Grades HSS and HSS5. TiAIN coated. Other diameters, grades and coatings on request.

Disponibile da diametro 66 mm a diametro 89 mm. Gradi HSS e HSS5. Rivestiti TiAIN. Diametri, gradi e rivestimenti diversi da quelli a catalogo disponibili su richiesta.

Serie/Series/Serie **W**

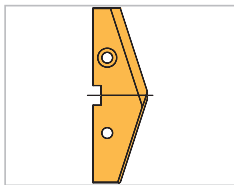

Seite
Page
Pagina **93**

Lieferbar in den Durchmessern von 90 mm bis 114 mm und den Sorten HSS und HSS5. TiAIN beschichtet. Weitere Durchmesser, Sorten und Beschichtungen auf Anfrage.

Available in diameter 90 mm up to 114 mm. Grades HSS and HSS5. TiAIN coated. Other diameters, grades and coatings on request.

Disponibile da diametro 90 mm a diametro 114 mm. Gradi HSS e HSS5. Rivestiti TiAIN. Diametri, gradi e rivestimenti diversi da quelli a catalogo disponibili su richiesta.

1

Universelle Geometrie für die Bearbeitung aller gängigen Werkstoffe. Mit Eckenschutzfase für hohe Standzeiten. Dank der ausgeprägten Schneide sind die Schneideinsätze selbstzentrierend und haben eine geringe Tendenz zum Verlaufen.

Lieferbarer Durchmesserbereich von **9,5 mm bis 114 mm**
Bestellbeispiel: **PE14 HSS5/TiAIN**

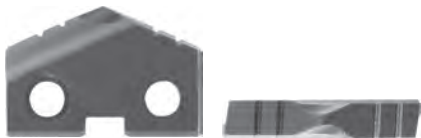

Universal geometry for drilling most common materials. With corner chamfer for better tool life. The drill point geometry makes the insert self-centering providing good hole straightness.

Available in diameter range **9.5 mm to 114 mm**
Ordering example: **PE14 HSS5/TiAIN**

Geometria da applicazione universale. Prima scelta per lavorabilità di qualsiasi materiale non trattato termicamente e a qualsiasi profondità di foratura. Bordo rinforzato per una maggiore durata e tagliente affilato per un migliore controllo truciolo.

Disponibile con gamma diametri da **9,5 mm a 114 mm**
Esempio d'ordine: **PE14 HSS5/TiAIN**

-AS

Unsere Geometrie „-AS“ mit speziell entwickelter Ausspitzung steht Ihnen in beschichteter (HSS5 und AK20 TiAIN) Variante zur Auswahl.

Nutzen Sie die Vorteile:

- reduzierte Vorschubkraft
- besseres Anbohrverhalten
- geringeres Verlaufen
- erste Wahl für tiefe Bohrungen
- reduziert Ausbrüche bei Durchgangsbohrungen

Lieferbarer Durchmesserbereich von **9,5 mm bis 35 mm**
Bestellbeispiel: **PE14-AS HSS5/TiAIN**

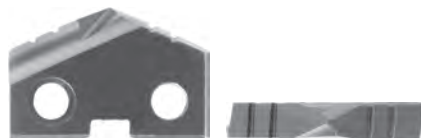

-AS

The „-AS“ geometry with especially developed edge is available in coated (HSS5 and AK20 TiAIN).

Advantages:

- lighter cutting action
- better pre-drilling ability
- improved straightness
- first choice for deep holes
- reduces outbreaks in throughholes

Available in diameter range **9.5 mm to 35 mm**
Ordering example: **PE14-AS HSS5/TiAIN**

-AS

La geometria „-AS“ con tagliente appositamente sviluppato è disponibile rivestita (HSS5 o nuda AK20 TiAIN).

Vantaggi:

- ridotte forze di taglio
- ottimo centraggio nei pre-fori
- migliore rettilineità del foro
- prima scelta per fori profondi
- ridotta rottura in uscita dai fori passanti

Disponibile con gamma diametri da **9,5 mm a 35 mm**
Esempio d'ordine: **PE14-AS HSS5/TiAIN**

-F Flachbohrmesser

Erweitern Sie mit den Flachbohrmessern „-F“ die Einsatzmöglichkeiten des SHARK-Drill®. Diese schnittige Geometrie mit Spanbrechern, sowie Eckenschutzfasen, lässt Sie (nur durch den Tausch der Bohrplatte) mit dem SHARK-Drill® nun auch Bohrungsgrundbearbeitungen oder Schraubensenkungen fertigen.

Lieferbarer Durchmesserbereich von **9,5 mm bis 47 mm**
Bestellbeispiel: **PE14-F HSS5/TiAIN**



-F for flat bottom

Increase the usage of the SHARK-Drill® with the flat bottom inserts. With only the change of an insert the SHARK-Drill® now also drills flat-bottom holes as well as screw counterbores.

Available in diameter range **9.5 mm to 47 mm**
Ordering example: **PE14-F HSS5/TiAIN**

-F a fondo piano

Ampliate l'uso delle punte SHARK-Drill® con gli inserti con fondo piano. Con un semplice cambio di un inserto le punte SHARK-Drill® realizzeranno fori a fondo piatto, oltre a barenature o lamature.

Disponibile con gamma diametri da **9,5 mm a 47 mm**
Esempio d'ordine: **PE14-F HSS5/TiAIN**

Beschichtet / Coated / Rivestito**AK10 TiAlN**

PVD-Mehrlagenbeschichtung,
Substrat K10 + TiAlN
Ausgestattet mit einer speziellen Geometrie zur Bearbeitung von Grauguss (GG). Vergrößerte Eckenfasen und der verstärkte Schneidkeil, in Verbindung mit der TiAlN-Beschichtung, erzielen höchste Standzeiten in diesen Materialien. Im Bohrbereich nur unter stabilen Schnittbedingungen einzusetzen.

*PVD-multilayer coating,
substrate K10 + TiAlN
Designed with a special geometry for drilling grey and white cast iron. Extended corner clips and stronger main cutting edge combined with the TiAlN coating offers maximum tool life in these materials. Use in strong and stabile cutting environment.*

Rivestimento PVD-multistrato,
substrato K10 + TiAlN
Inserito costruito appositamente per la foratura di ghise grigie e acciainose a truciolo corto. Profilo tagliente irrobustito e smusso maggiorato abbinato ad un idoneo rivestimento TiAlN per una ottimizzata applicazione su questi materiali. Da utilizzare in condizioni di massima stabilità e rigidità.

AK20 TiAlN

PVD-Mehrlagenbeschichtung,
Substrat K20 + TiAlN
K20 Hartmetall mit höherer Zähigkeit als AK10. Zur Bearbeitung sämtlicher Gusswerkstoffe, NE-Metalle, Titan- und Titanlegierungen. Ebenfalls einsetzbar im Stahlbereich bis ca. 5 – 7xD unter stabilen Schnittbedingungen.

*PVD-multilayer coating,
substrate K20 + TiAlN
K20 Carbide Grade with higher toughness as AK10 for machining all cast iron materials, nonferrous metals, Titanium and Titanium Alloys. Up to 3xD under best conditions also in steel possible. Only for usage in a stable cutting environment up to 5/7xD.*

Rivestimento PVD-multistrato,
substrato K20 + TiAlN
Grado di metallo duro K20 con maggiore tenacità di AK10 idoneo alla lavorazione di materiale da fusione, materiali non ferrosi, Titanio leghe di Titanio. Per foratura di acciaio, in ottimali condizioni di lavoro può essere utilizzato anche fino a 3xD. Per materiali più essere impiegato anche fino a 5/7xD in ottime condizioni di lavoro.

AP40 TiAlN

PVD-Mehrlagenbeschichtung,
Substrat P40 + TiAlN
P40 Hartmetall. Zur Bearbeitung von Stählen und, mit Einschränkungen, auch von rostfreien Stählen. Für eine HM-Sorte verhältnismäßig zäh. Einsatz bis ca. 5 – 7xD unter stabilen Schnittbedingungen.

*PVD-multilayer coating,
substrate P40 + TiAlN
P40 Carbide grade for machining steel and with restriction also stainless steel. It is our toughest carbide grade. Only for usage in a stable cutting-environment up to 5/7xD.*

Rivestimento PVD-multistrato,
substrato P40 + TiAlN
Metallo duro grado P40 per lavorare acciaio e limitatamente anche acciai inox. Questo è il nostro grado di metallo duro più tenace. Solo per utilizzo in stabili condizioni di lavorazione fino a 5/7xD.

HSS TiN

PVD-Mehrlagenbeschichtung,
HSS + TiN
HSS ohne Co-Gehalt. Unsere zähste Sorte. Sehr gute Verschleißerkennung durch die TiN Beschichtung. Geeignet für die Bearbeitung von Nichteisenmetallen. Auch unter ungünstigen Bearbeitungsbedingungen.

*PVD-multilayer coating,
HSS + TiN
HSS without Co content, our toughest Grade. TiN coating make it easier to recognise wear. The best grade for poor machining conditions. The best grade for poor basic conditions.*

Rivestimento PVD-multistrato,
HSS + TiN
HSS senza contenuto di Co. è il grado HSS più tenace. Il rivestimento TiN permette di monitorare l'usura del tagliente. Il grado migliore per condizioni di lavoro sfavorevoli o per un utilizzo generico.

HSS TiAlN

PVD-Mehrlagenbeschichtung,
HSS + TiAlN
HSS ohne Co-Gehalt. Unsere zähste Sorte. Erhöhte Verschleißfestigkeit und Temperaturbeständigkeit durch die PVD-Mehrlagenbeschichtung. Geeignet für die Bearbeitung von Stahl und rostfreiem Stahl. Auch unter ungünstigen Bedingungen.

*PVD-multilayer coating,
HSS + TiAlN
HSS without Co content, our toughest Grade. Due to PVD multilayer coating improved wear and temperature resistance. The best grade for poor basic conditions.*

Rivestimento PVD-multistrato,
HSS + TiAlN
HSS senza contenuto di Co è il grado HSS più tenace. Il rivestimento multistrato PVD ne aumenta la vita tagliente grazie alla resistenza all'usura ed alle alte temperature. Il grado migliore per condizioni di lavoro sfavorevoli.

Beschichtet / Coated / Rivestito**HSS5 TiAlN**

PVD-Mehrlagenbeschichtung, HSS5 + TiAlN
HSS mit 5% Co-Gehalt. Zähigkeit und Verschleißfestigkeit in einem ausgewogenen Verhältnis. Lieferbar im Durchmesserbereich 9,5 mm–114 mm.

*PVD-multilayer coating, HSS5 + TiAlN
HSS with 5% cobalt contents, stock item from 9.5 mm–114 mm. Often the most universal grade. Excellent combination of toughness and wear resistance.*

Rivestimento PVD-multistrato, HSS + TiAlN
HSS con 5% di contenuto di Co. A magazzino articoli disponibili da Ø 9,5 mm a Ø 114 mm. È il grado più universale. Tenacità e resistenza all'usura in giusta combinazione.

HSS8 TiAlN

PVD-Mehrlagenbeschichtung, HSS8 + TiAlN
HSS mit 8% Co-Gehalt. Durch die sehr hohe Verschleißfestigkeit erzielt diese Sorte bei stabilen Bedingungen die besten Standzeitergebnisse unter den HSS-Sorten. Lieferbar im Durchmesserbereich 9,5 mm–35 mm.

*PVD-multilayer coating, HSS8 + TiAlN
HSS with 8% cobalt content. Because of the high wear resistance, this grade offers the best tool life of all the HSS grades especially under stable machining conditions. Stock item from 9.5 mm–35 mm.*

Rivestimento PVD-multistrato, HSS8 + TiAlN
HSS con 8% di contenuto di Cobalto. Grazie alla elevata resistenza all'usura, questa qualità offre la migliore vita in-serto di tutti i gradi HSS dove le condizioni di lavoro sono ottimali. A magazzino articoli disponibili da Ø 9,5 mm a Ø 35 mm.

HSS8 TiCN

PVD-Mehrlagenbeschichtung, HSS8 + TiCN
HSS mit 8% Co-Gehalt. Sehr hohe Verschleißfestigkeit. Lieferbar im Durchmesserbereich 9,5 mm–35 mm. TiCN-Beschichtung für geringere Aufbauschneidenbildung in NE-Metallen. Gute Resultate bei vergüteten Stählen und größeren Bohrtiefen.

*PVD-multilayer coating, HSS8 + TiCN
HSS with 8% cobalt contents, stock item from 9.5 mm–35 mm. TiCN coating has less tendency to "bulid up edge" in non-ferrous metals. Good results in hardened and tempered steels also for deeper drill depths.*

Rivestimento PVD-multistrato, HSS8 + TiCN
HSS con 8% di contenuto di Cobalto, disponibile da Dia 9,5 mm–35 mm. Il rivestimento TiCN molto più duro del rivestimento TiAlN offre una maggiore resistenza all'usura e una limitata tendenza alla formazione del tagliente di riporto. Idoneo anche per lavorare acciai duri oppure su fori profondi.

Unbeschichtet / Uncoated / Non rivestito**AK20**

K20 Hartmetall mit höherer Zähigkeit als AK10. Zur Bearbeitung sämtlicher Gusswerkstoffe, NE-Metalle, Titan und Titan-Legierungen. Geringere Neigung zur Aufbauschneidenbildung im NE-Bereich. Im Bohrbereich nur unter stabilen Schnittbedingungen einzusetzen.

K20 Carbide Grade with higher toughness as AK10 for machining all cast iron materials, non-ferrous metals, Titanium and Titanium Alloys. Less tendency for build-up edges in non-ferrous metals. Only for usage in a stable cutting-environment.

Metallo duro grado K20 con maggiore tenacità rispetto ad AK10 per la lavorazione di tutte le ghise e materiali non ferrosi, Titanio e leghe di Titanio, materiali induriti fino a 55 HRC. Minore tendenza alla creazione del tagliente di riporto nei materiali non ferrosi. Solo per uso in stabili condizioni di lavorazione.

Serie / Series / Serie

A

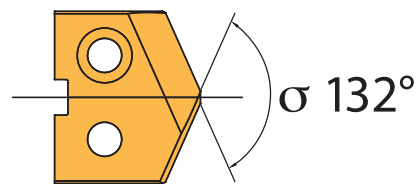

Schneidplatten / Inserts / Inserti

Bezeichnung Designation Articolo	Durchmesser Diameter Diametro			beschichtet coated rivestito							unbeschichtet uncoated non rivestito		
	[mm]	[decimal]	[inch]	AK10 TiAlN	AK20 TiAlN	AP40 TiAlN	HSS TiN	HSS TiAlN	HSS 5 TiN	HSS 5 TiAlN	HSS 8 TiAlN	HSS 8 TiCN	AK 20
PA9.5	9,5	0,3740"		●	●	●				●	●	●	●
PA9.53	9,53	0,3750"	3/8							●			
PA9.8	9,8	0,3860"		●	●	●				●	●	●	●
PA9.92	9,92	0,3906"	25/64			●				●			
PA10	10,0	0,3937"		●	●	●				●	●	●	●
PA10.2	10,2	0,4016"		●	●	●				●	●	●	●
PA10.32	10,32	0,4060"	13/32							●			
PA10.5	10,5	0,4134"		●	●	●				●	●	●	●
PA10.72	10,72	0,4220"	27/64							●			
PA10.8	10,8	0,4252"		●	●	●				●	●	●	●
PA11	11,0	0,4331"		●	●	●				●	●	●	●

<p>Kleinste Verpackungseinheit: 2 Stück Packed in two's = minimum quantity Confezione da 2 pezzi = Quantitativo minimo di acquisto</p>	<p>● Hauptanwendung Main Application Applicazione principale</p> <p>○ Nebenanwendung Secondary application Applicazione secondaria</p>	<table border="1"> <tr><td>P</td><td></td><td>○</td><td>●</td><td></td><td></td><td></td><td></td><td>●</td><td>●</td><td>●</td><td></td><td></td></tr> <tr><td>M</td><td></td><td></td><td></td><td>○</td><td></td><td></td><td></td><td></td><td>●</td><td>●</td><td>○</td><td></td></tr> <tr><td>K</td><td>●</td><td>●</td><td></td><td></td><td></td><td></td><td></td><td></td><td></td><td></td><td>○</td><td>●</td></tr> <tr><td>N</td><td></td><td>●</td><td></td><td></td><td></td><td></td><td></td><td></td><td></td><td></td><td>●</td><td>●</td></tr> <tr><td>S</td><td></td><td>○</td><td></td><td></td><td></td><td></td><td></td><td></td><td>○</td><td>●</td><td></td><td></td></tr> <tr><td>H</td><td></td><td></td><td></td><td></td><td></td><td></td><td></td><td></td><td></td><td></td><td></td><td></td></tr> </table>	P		○	●					●	●	●			M				○					●	●	○		K	●	●									○	●	N		●									●	●	S		○							○	●			H												
P		○	●					●	●	●																																																																						
M				○					●	●	○																																																																					
K	●	●									○	●																																																																				
N		●									●	●																																																																				
S		○							○	●																																																																						
H																																																																																

1

Serie / Series / Serie

A

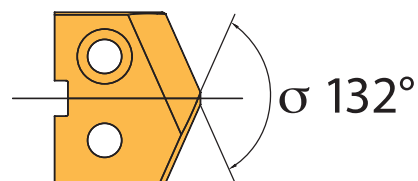

Schneidplatten / Inserts / Inserti

AS Geometrie / Geometry / Geometria

Bezeichnung Designation Articolo	Durchmesser Diameter Diametro			beschichtet coated rivestito							unbeschichtet uncoated non rivestito		
	[mm]	[decimal]	[inch]	AK10 TiAlN	AK20 TiAlN	AP40 TiAlN	HSS TiN	HSS TiAlN	HSS 5 TiN	HSS 5 TiAlN	HSS 8 TiAlN	HSS 8 TiCN	AK 20
PA9.5-AS	9,5	0,3740"			●					●			
PA9.8-AS	9,8	0,3860"			●					●			
PA10-AS	10,0	0,3937"			●					●			
PA10.2-AS	10,2	0,4016"			●					●			
PA10.5-AS	10,5	0,4134"			●					●			
PA10.8-AS	10,8	0,4252"			●					●			
PA11-AS	11,0	0,4331"			●					●			

<p>Kleinste Verpackungseinheit: 2 Stück Packed in two's = minimum quantity Confezione da 2 pezzi = Quantitativo minimo di acquisto</p> <p>"AS" geometry not available for the US market.</p>	<p>● Hauptanwendung Main Application Applicazione principale</p> <p>○ Nebenanwendung Secondary application Applicazione secondaria</p>	<table border="1"> <tr><td>P</td><td></td><td>○</td><td></td><td></td><td></td><td></td><td></td><td></td><td>●</td><td></td><td></td><td></td></tr> <tr><td>M</td><td></td><td></td><td></td><td></td><td></td><td></td><td></td><td></td><td></td><td>●</td><td></td><td></td></tr> <tr><td>K</td><td></td><td>●</td><td></td><td></td><td></td><td></td><td></td><td></td><td></td><td></td><td></td><td></td></tr> <tr><td>N</td><td></td><td>●</td><td></td><td></td><td></td><td></td><td></td><td></td><td></td><td></td><td></td><td></td></tr> <tr><td>S</td><td></td><td>○</td><td></td><td></td><td></td><td></td><td></td><td></td><td>○</td><td></td><td></td><td></td></tr> <tr><td>H</td><td></td><td></td><td></td><td></td><td></td><td></td><td></td><td></td><td></td><td></td><td></td><td></td></tr> </table>	P		○							●				M										●			K		●											N		●											S		○							○				H												
P		○							●																																																																							
M										●																																																																						
K		●																																																																														
N		●																																																																														
S		○							○																																																																							
H																																																																																

Hinweis: Zwischenabmessungen, die hier nicht aufgeführt sind, schleifen und beschichten wir Ihnen ab 5 Stück ohne Mehrpreis!

Remark: Other none standard diameters are available upon request.

Attenzione: Misure non indicate sono disponibili senza incremento prezzo per minimo 5pz.

Serie / Series / Serie

A

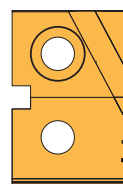

Schneidplatten / Inserts / Inserti

F Geometrie / Geometry / Geometria

Bezeichnung Designation Articolo	Durchmesser Diameter Diametro			beschichtet coated rivestito						unbeschichtet uncoated non rivestito			
	[mm]	[decimal]	[inch]	AK10 TiAlN	AK20 TiAlN	AP40 TiAlN	HSS TiN	HSS TiAlN	HSS 5 TiN	HSS 5 TiAlN	HSS 8 TiAlN	HSS 8 TiCN	AK 20
PA9.5-F	9,5	0,3740"								●			
PA9.8-F	9,8	0,3860"								●			
PA10-F	10,0	0,3937"								●			
PA10.2-F	10,2	0,4016"								●			
PA10.5-F	10,5	0,4134"								●			
PA10.8-F	10,8	0,4252"								●			
PA11-F	11,0	0,4331"								●			
Kleinste Verpackungseinheit: 2 Stück Packed in two's = minimum quantity Confezione da 2 pezzi = Quantitativo minimo di acquisto				<input checked="" type="radio"/> Hauptanwendung Main Application Applicazione principale				<input type="radio"/> Nebenanwendung Secondary application Applicazione secondaria					
				P						●			
				M						●			
				K									
				N									
				S						○			
				H									

Serie / Series / Serie

C

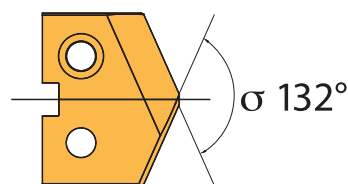

Schneidplatten / Inserts / Inserti

Bezeichnung Designation Articolo	Durchmesser Diameter Diametro			beschichtet coated rivestito						unbeschichtet uncoated non rivestito			
	[mm]	[decimal]	[inch]	AK10 TiAlN	AK20 TiAlN	AP40 TiAlN	HSS TiN	HSS TiAlN	HSS 5 TiN	HSS 5 TiAlN	HSS 8 TiAlN	HSS 8 TiCN	AK 20
PC11.11	11,11	0,4375"	7/16							●			
PC11.5	11,5	0,4528"		●	●	●				●	●	●	●
PC11.51	11,51	0,4530"	29/64							●			
PC11.55	11,55	0,4547"			●								
PC11.8	11,8	0,4646"				●							
PC11.91	11,91	0,4690"	15/32							●			
PC12	12,0	0,4724"		●	●	●			●	●	●	●	●
PC12.3	12,3	0,4844"	31/64							●			
PC12.5	12,5	0,4921"		●	●	●				●	●	●	●
PC12.7	12,7	0,5000"	1/2							●			
PC12.8	12,8	0,5039"		●	●	●				●	●	●	●
Kleinste Verpackungseinheit: 2 Stück Packed in two's = minimum quantity Confezione da 2 pezzi = Quantitativo minimo di acquisto				<input checked="" type="radio"/> Hauptanwendung Main Application Applicazione principale				<input type="radio"/> Nebenanwendung Secondary application Applicazione secondaria					
				P	○	●			●	●	●	●	
				M		○			●	●	●	○	
				K	●	●					○		●
				N		●						●	●
				S		○			○	○	●		
				H									

Hinweis: Zwischenabmessungen, die hier nicht aufgeführt sind, schleifen und beschichten wir Ihnen ab 5 Stück ohne Mehrpreis!

Remark: Other none standard diameters are available upon request.

Attenzione: Misure non indicate sono disponibili senza incremento prezzo per minimo 5pz.

Serie / Series / Serie

C

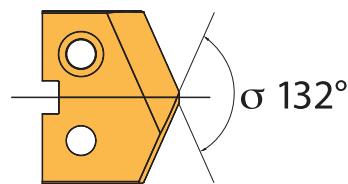

Schneidplatten / Inserts / Inserti

AS Geometrie / Geometry / Geometria

Bezeichnung Designation Articolo	Durchmesser Diameter Diametro			beschichtet coated rivestito						unbeschichtet uncoated non rivestito				
	[mm]	[decimal]	[inch]	AK10 TiAlN	AK20 TiAlN	AP40 TiAlN	HSS TiN	HSS TiAlN	HSS 5 TiN	HSS 5 TiAlN	HSS 8 TiAlN	HSS 8 TiCN	AK 20	
PC11.5-AS	11,5	0,4528"			●					●				
PC12-AS	12,0	0,4724"			●					●				
PC12.5-AS	12,5	0,4921"			●					●				
PC12.8-AS	12,8	0,5039"			●					●				
Kleinste Verpackungseinheit: 2 Stück Packed in twos = minimum quantity Confezione da 2 pezzi = Quantitativo minimo di acquisto				● Hauptanwendung Main Application Applicazione principale				P			○			
				● Nebenanwendung Secondary application Applicazione secondaria				M			○			
"AS" geometry not available for the US market.								K			●			
								N			●			
								S			○			
								H						

Serie / Series / Serie

C



Schneidplatten / Inserts / Inserti

F Geometrie / Geometry / Geometria

Bezeichnung Designation Articolo	Durchmesser Diameter Diametro			beschichtet coated rivestito						unbeschichtet uncoated non rivestito				
	[mm]	[decimal]	[inch]	AK10 TiAlN	AK20 TiAlN	AP40 TiAlN	HSS TiN	HSS TiAlN	HSS 5 TiN	HSS 5 TiAlN	HSS 8 TiAlN	HSS 8 TiCN	AK 20	
PC11.5-F	11,5	0,4528"								●				
PC12-F	12,0	0,4724"								●				
PC12.5-F	12,5	0,4921"								●				
PC12.8-F	12,8	0,5039"								●				
Kleinste Verpackungseinheit: 2 Stück Packed in twos = minimum quantity Confezione da 2 pezzi = Quantitativo minimo di acquisto				● Hauptanwendung Main Application Applicazione principale				P			○			
				● Nebenanwendung Secondary application Applicazione secondaria				M			○			
								K			●			
								N			●			
								S			○			
								H						

Hinweis: Zwischenabmessungen, die hier nicht aufgeführt sind, schleifen und beschichten wir Ihnen ab 5 Stück ohne Mehrpreis!

Remark: Other none standard diameters are available upon request.

Attenzione: Misure non indicate sono disponibili senza incremento prezzo per minimo 5pz.

Serie / Series / Serie E + G

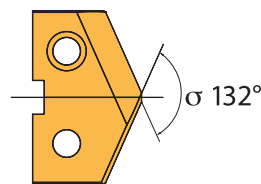

Schneidplatten / Inserts / Inserti

1

Bezeichnung Designation Articolo	Durchmesser Diameter Diametro			beschichtet coated rivestito							unbeschichtet uncoated non rivestito		
	[mm]	[decimal]	[inch]	AK10 TiAlN	AK20 TiAlN	AP40 TiAlN	HSS TiN	HSS TiAlN	HSS 5 TiN	HSS 5 TiAlN	HSS 8 TiAlN	HSS 8 TiCN	AK 20
PE13	13,0	0,5118"		●	●	●				●	●	●	●
PE13.1	13,1	0,5156"	33/64		●					●			
PE13.15	13,15	0,5177"									●		
PE13.49	13,49	0,5310"	17/32							●			
PE13.5	13,5	0,5315"		●	●	●				●	●	●	●
PE13.8	13,8	0,5433"		●	●	●				●	●	●	●
PE14	14,0	0,5512"		●	●	●			●	●	●	●	●
PE14.29	14,29	0,5626"	9/16							●			
PE14.3	14,3	0,5630"			●								
PE14.5	14,5	0,5709"		●	●	●				●	●	●	●
PE14.68	14,68	0,5779"	37/64							●			
PE14.8	14,8	0,5827"		●	●	●				●	●	●	●
PE15	15,0	0,5906"		●	●	●				●	●	●	●
PE15.08	15,08	0,5940"	19/32							●			
PE15.2	15,2	0,5984"								●			
PE15.5*	15,5	0,6102"		●	●	●				●	●	●	●
PE15.8*	15,8	0,6220"		●	●	●				●	●	●	●
PE15.88*	15,88	0,6252"	5/8							●			
PE16*	16,0	0,6299"		●	●	●			●	●	●	●	●
PE16.05*	16,05	0,6319"							●				
PE16.1*	16,1	0,6339"				●			●				
PE16.27*	16,27	0,6406"	41/64							●	●		
PE16.3*	16,3	0,6417"			●								
PE16.5*	16,5	0,6496"		●	●	●				●	●	●	●
PE16.67*	16,67	0,6563"	21/32							●			
PE16.8*	16,8	0,6614"		●	●	●				●	●	●	●
PE17*	17,0	0,6693"		●	●	●				●	●	●	●
PE17.46*	17,46	0,6870"	11/16							●			
PE17.5*	17,5	0,6890"		●	●	●				●	●	●	●
PE17.86*	17,86	0,7030"								●			

* Schneidplatten passend für Halter der Serie E und G
* Inserts for use in holders serie E and G
* Inserto per corpi serie E e G

Kleinste Verpackungseinheit: 2 Stück
Packed in two's = minimum quantity
Confezione da 2 pezzi = Quantitativo minimo di acquisto

● Hauptanwendung
Main Application
Applicazione principale

○ Nebenanwendung
Secondary application
Applicazione secondaria

	P	M	K	N	S	H
● Hauptanwendung	●	○	●			
○ Nebenanwendung	●	●	○	○	○	○

Hinweis: Zwischenabmessungen, die hier nicht aufgeführt sind, schleifen und beschichten wir Ihnen ab 5 Stück ohne Mehrpreis!

Remark: Other none standard diameters are available upon request.

Attenzione: Misure non indicate sono disponibili senza incremento prezzo per minimo 5pz.

Serie / Series / Serie E + G

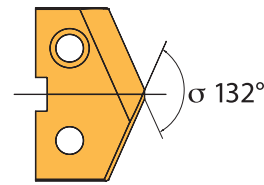

Schneidplatten / Inserts / Inserti AS Geometrie / Geometry / Geometria

Bezeichnung Designation Articolo	Durchmesser Diameter Diametro			beschichtet coated rivestito								unbeschichtet uncoated non rivestito	
	[mm]	[decimal]	[inch]	AK10 TiAlN	AK20 TiAlN	AP40 TiAlN	HSS TiN	HSS TiAlN	HSS 5 TiN	HSS 5 TiAlN	HSS 8 TiAlN	HSS 8 TiCN	AK 20
PE13-AS	13,0	0,5118"			●					●			
PE13.5-AS	13,5	0,5315"			●					●			
PE13.8-AS	13,8	0,5433"			●					●			
PE14-AS	14,0	0,5512"			●					●			
PE14.5-AS	14,5	0,5709"			●					●			
PE14.8-AS	14,8	0,5827"			●					●			
PE15-AS	15,0	0,5906"			●					●			
PE15.5-AS*	15,5	0,6102"			●					●			
PE15.8-AS*	15,8	0,6220"			●					●			
PE16-AS*	16,0	0,6299"			●					●			
PE16.5-AS*	16,5	0,6496"			●					●			
PE16.8-AS*	16,8	0,6614"			●					●			
PE17-AS*	17,0	0,6693"			●					●			
PE17.5-AS*	17,5	0,6890"			●					●			
* Schneidplatten passend für Halter der Serie E und G * Inserts for use in holders serie E and G * Inserto per corpi serie E e G				● Hauptanwendung Main Application Applicazione principale	P	○				●			
					M					●			
Kleinste Verpackungseinheit: 2 Stück Packed in two's = minimum quantity Confezione da 2 pezzi = Quantitativo minimo di acquisto				○ Nebenanwendung Secondary application Applicazione secondaria	K	●							
					N	●							
"-AS" geometry not available for the US market.					S	○				○			
					H								



Hinweis: Zwischenabmessungen, die hier nicht aufgeführt sind, schleifen und beschichten wir Ihnen ab 5 Stück ohne Mehrpreis!

Remark: Other none standard diameters are available upon request.

Attenzione: Misure non indicate sono disponibili senza incremento prezzo per minimo 5pz.

Serie / Series / Serie E + G

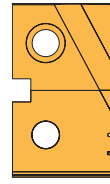

Schneidplatten / Inserts / Inserti F Geometrie / Geometry / Geometria

1

Bezeichnung Designation Articolo	Durchmesser Diameter Diametro			beschichtet coated rivestito							unbeschichtet uncoated non rivestito		
	[mm]	[decimal]	[inch]	AK10 TiAlN	AK20 TiAlN	AP40 TiAlN	HSS TiN	HSS TiAlN	HSS 5 TiN	HSS 5 TiAlN	HSS 8 TiAlN	HSS 8 TiCN	AK 20
PE13-F	13,0	0,5118"								●			
PE13.5-F	13,5	0,5315"								●			
PE13.8-F	13,8	0,5433"								●			
PE14-F	14,0	0,5512"								●			
PE14.5-F	14,5	0,5709"								●			
PE14.8-F	14,8	0,5827"								●			
PE15-F	15,0	0,5906"								●			
PE15.5-F*	15,5	0,6102"								●			
PE15.8-F*	15,8	0,6220"								●			
PE16-F*	16,0	0,6299"								●			
PE16.5-F*	16,5	0,6496"						●		●			
PE16.8-F*	16,8	0,6614"								●			
PE17-F*	17,0	0,6693"								●			
PE17.5-F*	17,5	0,6890"								●			

* Schneidplatten passend für Halter der Serie E und G
* Inserts for use in holders serie E and G
* Inserto per corpi serie E e G

Kleinste Verpackungseinheit: 2 Stück
Packed in two's = minimum quantity
Confezione da 2 pezzi = Quantitativo minimo di acquisto

- **Hauptanwendung**
Main Application
Applicazione principale
- **Nebenanwendung**
Secondary application
Applicazione secondaria

P								●	●				
M								●	●				
K													
N													
S								○	○				
H													

Hinweis: Zwischenabmessungen, die hier nicht aufgeführt sind, schleifen und beschichten wir Ihnen ab 5 Stück ohne Mehrpreis!

Remark: Other none standard diameters are available upon request.

Attenzione: Misure non indicate sono disponibili senza incremento prezzo per minimo 5pz.

Serie / Series / Serie I + K

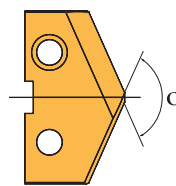

Schneidplatten / Inserts / Inserti

Bezeichnung Designation Articolo	Durchmesser Diameter Diametro			beschichtet coated rivestito								unbeschichtet uncoated non rivestito	
	[mm]	[decimal]	[inch]	AK10 TiAlN	AK20 TiAlN	AP40 TiAlN	HSS TiN	HSS TiAlN	HSS 5 TiN	HSS 5 TiAlN	HSS 8 TiAlN	HSS 8 TiCN	AK 20
PI17.5	17,5	0,6890"											
PI17.8	17,8	0,7008"		•	•	•			•	•	•	•	•
PI17.86	17,86	0,7030"	45/64							•			
PI18	18,0	0,7087"		•	•	•		•		•	•	•	•
PI18.26	18,26	0,7190"	23/32							•			
PI18.5	18,5	0,7283"		•	•	•				•	•	•	•
PI18.65	18,65	0,7343"	47/64							•			
PI18.8	18,8	0,7402"		•	•	•				•	•	•	•
PI19	19,0	0,7480"		•	•	•		•		•	•	•	•
PI19.05	19,05	0,7500"	3/4							•		•	
PI19.45	19,45	0,7660"	49/64							•			
PI19.5	19,5	0,7677"		•	•	•		•		•	•	•	•
PI19.8	19,8	0,7795"		•	•	•	•			•	•	•	•
PI19.84	19,84	0,7811"	25/32							•			
PI19.95	19,95	0,7854"					•						
PI20	20,0	0,7874"		•	•	•	•	•		•	•	•	•
PI20.15	20,15	0,7933"					•						
PI20.2	20,2	0,7953"					•						
PI20.5	20,5	0,8071"		•	•	•	•			•	•	•	•
PI20.64	20,64	0,8130"	13/16							•			
PI20.7	20,7	0,8150"		•	•	•				•	•	•	•
PI21	21,0	0,8268"		•	•	•		•		•	•	•	•
PI21.43	21,43	0,8437"	27/32							•			
PI21.5	21,5	0,8465"		•	•	•				•	•	•	•
PI21.7	21,7	0,8543"		•	•	•				•	•	•	•
PI21.95	21,95	0,8642"					•						
PI22*	22,0	0,8661"		•	•	•	•	•		•	•	•	•
PI22.23*	22,23	0,8750"	7/8				•			•			
PI22.4*	22,4	0,8819"						•					
PI22.5*	22,5	0,8858"		•	•	•				•	•	•	•
PI22.62*	22,62	0,8906"								•			
PI22.7*	22,7	0,8937"		•	•	•				•	•	•	•
PI23*	23,0	0,9055"		•	•	•				•	•	•	•
PI23.02*	23,02	0,9060"	29/32							•			
PI23.42*	23,42	0,9220"	59/64							•			
PI23.5*	23,5	0,9252"		•	•	•		•		•	•	•	•
PI23.7*	23,7	0,9331"		•	•	•				•	•	•	•
PI23.81*	23,81	0,9370"	15/16							•			
PI24*	24,0	0,9449"		•	•	•		•		•	•	•	•
PI24.21*	24,21	0,9531"								•			

* Schneidplatten passend für Halter der Serie I und K
* Inserts for use in holders serie I and K
* Inserto per corpi serie I e K

• **Hauptanwendung**
Main Application
Applicazione principale

○ **Nebenanwendung**
Secondary application
Applicazione secondaria

P		○	•	•	•	•	•	•	•	•	•	•	
M			○	○	○	•	•	•	•	•	○		
K	•	•									○		•
N		•										•	•
S		○						○	○	•			
H													

Hinweis: Zwischenabmessungen, die hier nicht aufgeführt sind, schleifen und beschichten wir Ihnen ab 5 Stück ohne Mehrpreis!

Remark: Other none standard diameters are available upon request.

Attenzione: Misure non indicate sono disponibili senza incremento prezzo per minimo 5pz.



Serie / Series / Serie I + K

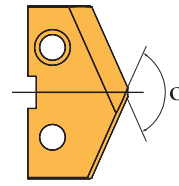

Schneidplatten / Inserts / Inserti AS Geometrie / Geometry / Geometria

1

Bezeichnung Designation Articolo	Durchmesser Diameter Diametro			beschichtet coated rivestito							unbeschichtet uncoated non rivestito		
	[mm]	[decimal]	[inch]	AK10 TiAlN	AK20 TiAlN	AP40 TiAlN	HSS TiN	HSS TiAlN	HSS 5 TiN	HSS 5 TiAlN	HSS 8 TiAlN	HSS 8 TiCN	AK 20
PI17.8-AS	17,8	0,7008"			●					●			
PI18-AS	18,0	0,7087"			●					●			
PI18.5-AS	18,5	0,7283"			●					●			
PI18.8-AS	18,8	0,7402"			●					●			
PI19-AS	19,0	0,7480"			●					●			
PI19.5-AS	19,5	0,7677"			●					●			
PI19.8-AS	19,8	0,7795"			●					●			
PI20-AS	20,0	0,7874"			●					●			
PI20.5-AS	20,5	0,8071"			●					●			
PI20.7-AS	20,7	0,8150"			●					●			
PI21-AS	21,0	0,8268"			●					●			
PI21.5-AS	21,5	0,8465"			●					●			
PI21.7-AS	21,7	0,8543"			●					●			
PI22-AS*	22,0	0,8661"			●					●			
PI22.5-AS*	22,5	0,8858"			●					●			
PI22.7-AS*	22,7	0,8937"			●					●			
PI23-AS*	23,0	0,9055"			●					●			
PI23.5-AS*	23,5	0,9252"			●					●			
PI23.7-AS*	23,7	0,9331"			●					●			
PI24-AS*	24,0	0,9449"			●					●			

* Schneidplatten passend für Halter der Serie I und K
* Inserts for use in holders serie I and K
* Inserto per corpi serie I e K

"AS" geometry not available for the US market.

● Hauptanwendung
Main Application
Applicazione principale

○ Nebenanwendung
Secondary application
Applicazione secondaria

P	○	●		
M		●		
K	●			
N	●			
S	○		○	
H				

Hinweis: Zwischenabmessungen, die hier nicht aufgeführt sind, schleifen und beschichten wir Ihnen ab 5 Stück ohne Mehrpreis!

Remark: Other none standard diameters are available upon request.

Attenzione: Misure non indicate sono disponibili senza incremento prezzo per minimo 5pz.

Serie / Series / Serie I + K

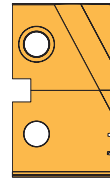

Schneidplatten / Inserts / Inserti F Geometrie / Geometry / Geometria

Bezeichnung Designation Articolo	Durchmesser Diameter Diametro			beschichtet coated rivestito							unbeschichtet uncoated non rivestito		
	[mm]	[decimal]	[inch]	AK10 TiAlN	AK20 TiAlN	AP40 TiAlN	HSS TiN	HSS TiAlN	HSS 5 TiN	HSS 5 TiAlN	HSS 8 TiAlN	HSS 8 TiCN	AK 20
PI17.8-F	17,8	0,7008"								●			
PI18-F	18,0	0,7087"								●			
PI18.5-F	18,5	0,7283"								●			
PI18.8-F	18,8	0,7402"								●			
PI19-F	19,0	0,7480"								●			
PI19.5-F	19,5	0,7677"								●			
PI19.8-F	19,8	0,7795"								●			
PI20-F	20,0	0,7874"								●			
PI20.5-F	20,5	0,8071"								●			
PI20.7-F	20,7	0,8150"								●			
PI21-F	21,0	0,8268"								●			
PI21.5-F	21,5	0,8465"								●			
PI21.7-F	21,7	0,8543"								●			
PI22-F*	22,0	0,8661"								●			
PI22.5-F*	22,5	0,8858"								●			
PI22.7-F*	22,7	0,8937"								●			
PI23-F*	23,0	0,9055"								●			
PI23.5-F*	23,5	0,9252"								●			
PI23.7-F*	23,7	0,9331"								●			
PI24-F*	24,0	0,9449"								●			

* Schneidplatten passend für Halter der Serie I und K
* Inserts for use in holders serie I and K
* Inserto per corpi serie I e K

- Hauptanwendung
Main Application
Applicazione principale
- Nebenanwendung
Secondary application
Applicazione secondaria

P	●	
M	●	
K		
N		
S	○	
H		

Hinweis: Zwischenabmessungen, die hier nicht aufgeführt sind, schleifen und beschichten wir Ihnen ab 5 Stück ohne Mehrpreis!

Remark: Other none standard diameters are available upon request.

Attenzione: Misure non indicate sono disponibili senza incremento prezzo per minimo 5pz.

Serie / Series / Serie M + O

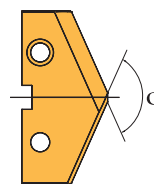

Schneidplatten / Inserts / Inserti

1

Bezeichnung Designation Articolo	Durchmesser Diameter Diametro			beschichtet coated rivestito								unbeschichtet uncoated non rivestito	
	[mm]	[decimal]	[inch]	AK10 TiAlN	AK20 TiAlN	AP40 TiAlN	HSS TiN	HSS TiAlN	HSS 5 TiN	HSS 5 TiAlN	HSS 8 TiAlN	HSS 8 TiCN	AK 20
PM24.5	24,5	0,9646"		●	●	●				●	●	●	●
PM24.61	24,61	0,9688"	31/32	●			●			●			
PM24.7	24,7	0,9724"					●						
PM24.85	24,85	0,9783"					●						
PM24.95	24,95	0,9823"					●						
PM25	25,0	0,9843"	63/64	●	●	●	●	●		●	●	●	●
PM25.4	25,4	1,0000"	1							●			
PM25.5	25,5	1,0040"		●	●	●				●	●	●	●
PM25.7	25,7	1,0118"								●			
PM25.8	25,8	1,0157"	1 1/64							●			
PM26	26,0	1,0236"		●	●	●	●	●		●	●	●	●
PM26.19	26,19	1,0313"	1 1/32				●	●					
PM26.5	26,5	1,0433"		●	●	●				●	●	●	●
PM26.6	26,6	1,0472"					●						
PM26.7	26,7	1,0512"					●						
PM26.8	26,8	1,0551"			●								
PM26.99	26,99	1,0630"								●			
PM27	27,0	1,0630"	1 1/16	●	●	●	●	●		●	●	●	●
PM27.4	27,4	1,0787"						●					
PM27.5	27,5	1,0827"		●	●	●	●			●	●	●	●
PM27.7	27,7	1,0906"					●						
PM27.78	27,78	1,0938"	1 3/32				●	●					
PM27.8	27,8	1,0945"					●						
PM28	28,0	1,1024"		●	●	●	●	●		●	●	●	●
PM28.3	28,3	1,1141"					●						
PM28.5	28,5	1,1220"		●	●	●				●	●	●	●
PM28.58	28,58	1,1252"	1 1/8							●			
PM29	29,0	1,1417"		●	●	●	●	●		●	●	●	●
PM29.37	29,37	1,1563"	1 5/32				●						
PM29.5	29,5	1,1614"		●	●	●	●			●	●	●	●
PM29.9	29,9	1,1772"					●						
PM30*	30,0	1,1811"		●	●	●	●	●		●	●	●	●
PM30.16*	30,16	1,1874"	1 3/16							●			
PM30.5*	30,5	1,2007"		●	●	●		●		●	●	●	●
PM30.7*	30,7	1,2087"								●			
PM30.96*	30,96	1,2190"	1 7/32							●			
PM31*	31,0	1,2205"		●	●	●	●	●		●	●	●	●
PM31.5*	31,5	1,2402"		●	●	●				●	●	●	●

* Schneidplatten passend für Halter der Serie M und O
* Inserts for use in holders serie M and O
* Inserto per corpi serie M e O

● Hauptanwendung
Main Application
Applicazione principale

○ Nebenanwendung
Secondary application
Applicazione secondaria

	P	M	K	N	S	H
● Hauptanwendung	○	●	●	●	●	●
○ Nebenanwendung	●	●			○	●
		○	○	○	○	○
					○	●

Hinweis: Zwischenabmessungen, die hier nicht aufgeführt sind, schleifen und beschichten wir Ihnen ab 5 Stück ohne Mehrpreis!

Remark: Other none standard diameters are available upon request.

Attenzione: Misure non indicate sono disponibili senza incremento prezzo per minimo 5pz.

Schneidplatten / Inserts / Inserti

Bezeichnung Designation Articolo	Durchmesser Diameter Diametro			beschichtet coated rivestito							unbeschichtet uncoated non rivestito		
	[mm]	[decimal]	[inch]	AK10 TiAlN	AK20 TiAlN	AP40 TiAlN	HSS TiN	HSS TiAlN	HSS 5 TiN	HSS 5 TiAlN	HSS 8 TiAlN	HSS 8 TiCN	AK 20
PM31.7	31,7	1,2480"					●						
PM31.75*	31,75	1,2500"	1 1/4				●	●		●			
PM32*	32,0	1,2598"		●	●	●	●	●		●	●	●	●
PM32.5*	32,5	1,2795"		●	●	●		●		●	●	●	●
PM32.54*	32,54	1,2813"	1 9/32				●						
PM33*	33,0	1,2992"		●	●	●		●		●	●	●	●
PM33.34*	33,34	1,3130"	1 5/16							●			
PM33.5*	33,5	1,3189"		●	●	●				●	●	●	●
PM33.7*	33,7	1,3268"											●
PM34*	34,0	1,3386"		●	●	●	●	●		●	●	●	●
PM34.13*	34,13	1,3438"	1 11/32				●	●		●			
PM34.5*	34,5	1,3583"		●		●	●			●	●	●	●
PM34.7*	34,7	1,3661"								●			
PM34.93*	34,93	1,3752"	1 3/8							●			
PM35*	35,0	1,3780"		●	●	●	●	●		●	●	●	●

* Schneidplatten passend für Halter der Serie M und O * Inserts for use in holders serie M and O * Inserto per corpi serie M e O	● Hauptanwendung Main Application Applicazione principale	P		○	●	●	●	●	●	●	●		
	○ Nebenanwendung Secondary application Applicazione secondaria	M			○	○	○		●	●	○		
		K	●	●							○		●
		N		●								●	●
		S		○						○	●		
		H											

Hinweis: Zwischenabmessungen, die hier nicht aufgeführt sind, schleifen und beschichten wir Ihnen ab 5 Stück ohne Mehrpreis!

Remark: Other none standard diameters are available upon request.

Attenzione: Misure non indicate sono disponibili senza incremento prezzo per minimo 5pz.



Serie / Series / Serie M + O

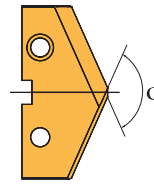

Schneidplatten / Inserts / Inserti AS Geometrie / Geometry / Geometria

1

Bezeichnung Designation Articolo	Durchmesser Diameter Diametro			beschichtet coated rivestito								unbeschichtet uncoated non rivestito	
	[mm]	[decimal]	[inch]	AK10 TiAlN	AK20 TiAlN	AP40 TiAlN	HSS TiN	HSS TiAlN	HSS 5 TiN	HSS 5 TiAlN	HSS 8 TiAlN	HSS 8 TiCN	AK 20
PM24.5-AS	24,5	0,9646"			●					●			
PM25-AS	25,0	0,9843"	63/64		●					●			
PM25.5-AS	25,5	1,0040"			●					●			
PM26-AS	26,0	1,0236"			●					●			
PM26.5-AS	26,5	1,0433"			●					●			
PM27-AS	27,0	1,0630"	1 1/16		●					●			
PM27.5-AS	27,5	1,0827"			●					●			
PM28-AS	28,0	1,1024"			●					●			
PM28.5-AS	28,5	1,1220"			●					●			
PM29-AS	29,0	1,1417"			●					●			
PM29.5-AS	29,5	1,1614"			●					●			
PM30-AS*	30,0	1,1811"			●					●			
PM30.5-AS*	30,5	1,2007"			●					●			
PM31-AS*	31,0	1,2205"			●					●			
PM31.5-AS*	31,5	1,2402"			●					●			
PM32-AS*	32,0	1,2598"			●					●			
PM32.5-AS*	32,5	1,2795"			●					●			
PM33-AS*	33,0	1,2992"			●					●			
PM33.5-AS*	33,5	1,3189"			●					●			
PM34-AS*	34,0	1,3386"			●					●			
PM34.5-AS*	34,5	1,3583"			●					●			
PM35-AS*	35,0	1,3780"			●					●			

* Schneidplatten passend für Halter der Serie M und O	● Hauptanwendung	P								●			
* Inserts for use in holders serie M and O	Main Application	M								●			
* Inserto per corpi serie M e O	Applicazione principale	K		●									
	○ Nebenanwendung	N		●									
	Secondary application	S								○			
	Applicazione secondaria	H											

“-AS” geometry not available for the US market.

Hinweis: Zwischenabmessungen, die hier nicht aufgeführt sind, schleifen und beschichten wir Ihnen ab 5 Stück ohne Mehrpreis!

Remark: Other none standard diameters are available upon request.

Attenzione: Misure non indicate sono disponibili senza incremento prezzo per minimo 5pz.

Serie / Series / Serie M + O



Schneidplatten / Inserts / Inserti F Geometrie / Geometry / Geometria

Bezeichnung Designation Articolo	Durchmesser Diameter Diametro			beschichtet coated rivestito							unbeschichtet uncoated non rivestito		
	[mm]	[decimal]	[inch]	AK10 TiAlN	AK20 TiAlN	AP40 TiAlN	HSS TiN	HSS TiAlN	HSS 5 TiAlN	HSS 5 TiAlN	HSS 8 TiAlN	HSS 8 TiCN	AK 20
PM24.5-F	24,5	0,9646"								●			
PM25-F	25,0	0,9843"	63/64							●			
PM25.5-F	25,5	1,0040"								●			
PM26-F	26,0	1,0236"								●			
PM26.5-F	26,5	1,0433"								●			
PM27-F	27,0	1,0630"	1 1/16							●			
PM27.5-F	27,5	1,0827"								●			
PM28-F	28,0	1,1024"								●			
PM28.5-F	28,5	1,1220"								●			
PM29-F	29,0	1,1417"								●			
PM29.5-F	29,5	1,1614"								●			
PM30-F*	30,0	1,1811"								●			
PM30.5-F*	30,5	1,2007"								●			
PM31-F*	31,0	1,2205"								●			
PM31.5-F*	31,5	1,2402"								●			
PM31.75-F*	31,75	1,2500"	1 1/4							●			
PM32-F*	32,0	1,2598"								●			
PM32.5-F*	32,5	1,2795"								●			
PM33-F*	33,0	1,2992"								●			
PM33.5-F*	33,5	1,3189"								●			
PM34-F*	34,0	1,3386"								●			
PM34.5-F*	34,5	1,3583"								●			
PM35-F*	35,0	1,3780"								●			

* Schneidplatten passend für Halter der Serie M und O
* Inserts for use in holders serie M and O
* Inserto per corpi serie M e O

- Hauptanwendung
Main Application
Applicazione principale
- Nebenanwendung
Secondary application
Applicazione secondaria

P	●		
M	●		
K			
N			
S	○		
H			

Hinweis: Zwischenabmessungen, die hier nicht aufgeführt sind, schleifen und beschichten wir Ihnen ab 5 Stück ohne Mehrpreis!

Remark: Other none standard diameters are available upon request.

Attenzione: Misure non indicate sono disponibili senza incremento prezzo per minimo 5pz.

Serie / Series / Serie

Q

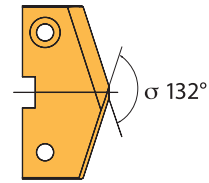

Schneidplatten / Inserts / Inserti

Bezeichnung Designation Articolo	Durchmesser Diameter Diametro			beschichtet coated rivestito							unbeschichtet uncoated non rivestito		
	[mm]	[decimal]	[inch]	AK10 TiAlN	AK20 TiAlN	AP40 TiAlN	HSS TiN	HSS TiAlN	HSS 5 TiN	HSS 5 TiAlN	HSS 8 TiAlN	HSS 8 TiCN	AK 20
PQ35	35,0	1,3780"								●			
PQ35.7	35,7	1,4005"						●					
PQ35.72	35,72	1,4063"	1 13/32							●			
PQ36	36,0	1,4173"		●	●		●	●		●			
PQ36.5	36,5	1,4370"				●							
PQ36.51	36,51	1,4375"	1 7/16				●						
PQ37	37,0	1,4567"		●	●			●		●			
PQ37.5	37,5	1,4764"								●			
PQ38	38,0	1,4961"		●	●			●		●			
PQ38.1	38,1	1,5000"	1 1/5							●			
PQ38.5	38,5	1,5157"								●			
PQ38.89	38,89	1,5311"	1 17/32							●			
PQ39	39,0	1,5354"		●	●		●	●		●			
PQ39.5	39,5	1,5551"								●			
PQ39.69	39,69	1,5625"	1 9/16				●	●					
PQ40	40,0	1,5748"		●	●			●		●			
PQ41	41,0	1,6142"		●	●			●		●			
PQ41.28	41,28	1,6250"	1 5/8							●			
PQ41.5	41,5	1,6339"								●			
PQ42	42,0	1,6535"		●	●		●	●		●			
PQ42.07	42,07	1,6563"	1 21/32				●						
PQ42.3	42,3	1,6654"								●			
PQ42.5	42,5	1,6732"					●	●					
PQ42.86	42,86	1,6875"	1 11/16				●						
PQ43	43,0	1,6929"		●	●		●			●			
PQ43.33	43,33	1,7059"								●			
PQ44	44,0	1,7323"		●	●			●		●			
PQ44.45	44,45	1,7500"	1 3/4							●			
PQ45	45,0	1,7717"		●	●			●		●			
PQ45.24	45,24	1,7811"	1 25/32							●			
PQ46	46,0	1,8110"		●	●			●		●			
PQ46.83	46,83	1,8438"	1 27/32				●	●					
PQ47	47,0	1,8504"		●	●		●	●		●			
PQ47.62	47,62	1,8748"								●			

- Hauptanwendung
Main Application
Applicazione principale
- Nebenanwendung
Secondary application
Applicazione secondaria

P	○	●	●	●	●	
M		○	○	○	●	
K	●					
N	●					
S	○				○	
H						

Hinweis: Zwischenabmessungen, die hier nicht aufgeführt sind, schleifen und beschichten wir Ihnen ab 5 Stück ohne Mehrpreis!

Remark: Other none standard diameters are available upon request.

Attenzione: Misure non indicate sono disponibili senza incremento prezzo per minimo 5pz.

Serie / Series / Serie

Q

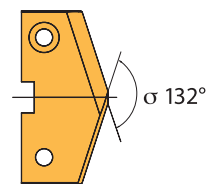

Schneidplatten / Inserts / Inserti

AS Geometrie / Geometry / Geometria

Bezeichnung Designation Articolo	Durchmesser Diameter Diametro			beschichtet coated rivestito							unbeschichtet uncoated non rivestito		
	[mm]	[decimal]	[inch]	AK10 TiAlN	AK20 TiAlN	AP40 TiAlN	HSS TiN	HSS TiAlN	HSS 5 TiAlN	HSS 5 TiAlN	HSS 8 TiAlN	HSS 8 TiCN	AK 20
PQ38-AS	38,0	1,4961"								●			
PQ39-AS	39,0	1,5354"								●			
PQ40-AS	40,0	1,5748"								●			
PQ41-AS	41,0	1,6142"								●			
PQ42-AS	42,0	1,6535"								●			
PQ43-AS	43,0	1,6929"								●			
PQ44-AS	44,0	1,7323"								●			
PQ45-AS	45,0	1,7717"								●			
"AS" geometry not available for the US market. ● Hauptanwendung Main Application Applicazione principale ○ Nebenanwendung Secondary application Applicazione secondaria				P						●			
				M						●			
				K									
				N									
				S						○			
				H									

1

Serie / Series / Serie

Q



Schneidplatten / Inserts / Inserti

F Geometrie / Geometry / Geometria

Bezeichnung Designation Articolo	Durchmesser Diameter Diametro			beschichtet coated rivestito							unbeschichtet uncoated non rivestito		
	[mm]	[decimal]	[inch]	AK10 TiAlN	AK20 TiAlN	AP40 TiAlN	HSS TiN	HSS TiAlN	HSS 5 TiAlN	HSS 5 TiAlN	HSS 8 TiAlN	HSS 8 TiCN	AK 20
PQ36-F	36,0	1,4173"								●			
PQ37-F	37,0	1,4567"								●			
PQ38-F	38,0	1,4961"								●			
PQ39-F	39,0	1,5354"								●			
PQ40-F	40,0	1,5748"								●			
PQ41-F	41,0	1,6142"								●			
PQ42-F	42,0	1,6535"								●			
PQ43-F	43,0	1,6929"								●			
PQ44-F	44,0	1,7323"								●			
PQ45-F	45,0	1,7717"								●			
PQ46-F	46,0	1,8110"								●			
PQ47-F	47,0	1,8504"								●			
● Hauptanwendung Main Application Applicazione principale ○ Nebenanwendung Secondary application Applicazione secondaria				P						●			
				M						●			
				K									
				N									
				S						○			
				H									

Serie / Series / Serie

S

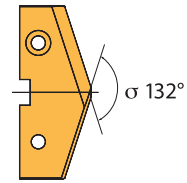

Schneidplatten / Inserts / Inserti

1

Bezeichnung Designation Articolo	Durchmesser Diameter Diametro			beschichtet coated rivestito							unbeschichtet uncoated non rivestito		
	[mm]	[decimal]	[inch]	AK10 TiAlN	AK20 TiAlN	AP40 TiAlN	HSS TiN	HSS TiAlN	HSS 5 TiN	HSS 5 TiAlN	HSS 8 TiAlN	HSS 8 TiCN	AK 20
PS48	48,0	1,8898"						●		●			
PS49	49,0	1,9291"					●	●		●			
PS49.21	49,21	1,9375"	1 15/16				●	●					
PS50	50,0	1,9685"						●		●			
PS50.8	50,8	2,0000"	2							●			
PS51	51,0	2,0079"						●		●			
PS52	52,0	2,0472"	2 3/64					●		●			
PS52.5	52,5	2,0669"								●			
PS53	53,0	2,0866"						●		●			
PS53.98	53,98	2,1252"	2 1/8							●			
PS54	54,0	2,1260"						●		●			
PS55	55,0	2,1654"								●			
PS56	56,0	2,2047"					●	●		●			
PS57	57,0	2,2441"						●		●			
PS57.15	57,15	2,2500"	2 1/4							●			
PS58	58,0	2,2835"						●		●			
PS59	59,0	2,3228"								●			
PS60	60,0	2,3622"					●			●			
PS61	61,0	2,4016"								●			
PS62	62,0	2,4409"					●			●			
PS63	63,0	2,4803"						●		●			
PS63.50	63,5	2,5000"	2 1/2							●			
PS64	64,0	2,5197"					●			●			
PS65	65,0	2,5591"						●		●			
● Hauptanwendung Main Application Applicazione principale	P						●	●		●			
	M						○	○		●			
○ Nebenanwendung Secondary application Applicazione secondaria	K												
	N												
	S									○			
	H												

Hinweis: Zwischenabmessungen, die hier nicht aufgeführt sind, schleifen und beschichten wir Ihnen ab 5 Stück ohne Mehrpreis!

Remark: Other none standard diameters are available upon request.

Attenzione: Misure non indicate sono disponibili senza incremento prezzo per minimo 5pz.

Serie / Series / Serie

S

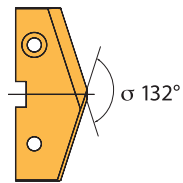

Schneidplatten / Inserts / Inserti

AS Geometrie / Geometry / Geometria

Bezeichnung Designation Articolo	Durchmesser Diameter Diametro			beschichtet coated rivestito							unbeschichtet uncoated non rivestito				
	[mm]	[decimal]	[inch]	AK10 TiAlN	AK20 TiAlN	AP40 TiAlN	HSS TiN	HSS TiAlN	HSS 5 TiN	HSS 5 TiAlN	HSS 8 TiAlN	HSS 8 TiCN	AK 20		
PS60-AS	60,0	2,3622"						●							
"AS" geometry not available for the US market.				<ul style="list-style-type: none"> ● Hauptanwendung Main Application Applicazione principale ○ Nebenanwendung Secondary application Applicazione secondaria 				P		●					
				M				○							
				K											
				N											
				S											
				H											



Hinweis: Zwischenabmessungen, die hier nicht aufgeführt sind, schleifen und beschichten wir Ihnen ab 5 Stück ohne Mehrpreis!

Remark: Other none standard diameters are available upon request.

Attenzione: Misure non indicate sono disponibili senza incremento prezzo per minimo 5pz.

Serie / Series / Serie

U

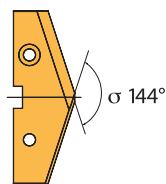

Schneidplatten / Inserts / Inserti

1

Bezeichnung Designation Articolo	Durchmesser Diameter Diametro			beschichtet coated rivestito								unbeschichtet uncoated non rivestito	
	[mm]	[decimal]	[inch]	AK10 TiAlN	AK20 TiAlN	AP40 TiAlN	HSS TiN	HSS TiAlN	HSS 5 TiN	HSS 5 TiAlN	HSS 8 TiAlN	HSS 8 TiCN	AK 20
PU66	66,0	2,5984"								●			
PU66.68	66,68	2,6252"	2 5/8							●			
PU67	67,0	2,6378"						●		●			
PU67.47	67,47	2,6563"	2 21/32							●			
PU68	68,0	2,6772"						●		●			
PU69	69,0	2,7165"								●			
PU69.85	69,85	2,7500"	2 3/4							●			
PU70	70,0	2,7559"						●		●			
PU71	71,0	2,7953"								●			
PU71.44	71,44	2,8126"								●			
PU72	72,0	2,8346"						●		●			
PU73	73,0	2,8740"						●		●			
PU74	74,0	2,9134"						●		●			
PU75	75,0	2,9528"								●			
PU76	76,0	2,9921"						●		●			
PU76.2	76,2	3,0000"	3							●			
PU77	77,0	3,0315"								●			
PU77.78	77,78	3,0620"								●			
PU78	78,0	3,0709"					●	●		●			
PU79	79,0	3,1102"						●		●			
PU80	80,0	3,1496"						●		●			
PU81	81,0	3,1890"								●			
PU82	82,0	3,2283"								●			
PU82.55	82,55	3,2500"								●			
PU83	83,0	3,2677"								●			
PU84	84,0	3,3071"								●			
PU84.93	84,93	3,3437"	3 11/32							●			
PU85	85,0	3,3465"								●			
PU86	86,0	3,3858"								●			
PU87	87,0	3,4252"								●			
PU88	88,0	3,4646"								●			
PU88.9	88,9	3,5000"	3 1/2							●			
PU89	89,0	3,5039"								●			

● Hauptanwendung Main Application Applicazione principale	P	M	K	N	S	H
	●	●				
○ Nebenanwendung Secondary application Applicazione secondaria		○	○			
					○	

Hinweis: Zwischenabmessungen, die hier nicht aufgeführt sind, schleifen und beschichten wir Ihnen ab 5 Stück ohne Mehrpreis!

Remark: Other none standard diameters are available upon request.

Attenzione: Misure non indicate sono disponibili senza incremento prezzo per minimo 5pz.

Serie / Series / Serie W

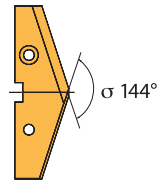

Schneidplatten / Inserts / Inserti

Bezeichnung Designation Articolo	Durchmesser Diameter Diametro			beschichtet coated rivestito							unbeschichtet uncoated non rivestito		
	[mm]	[decimal]	[inch]	AK10 TiAlN	AK20 TiAlN	AP40 TiAlN	HSS TiN	HSS TiAlN	HSS 5 TiN	HSS 5 TiAlN	HSS 8 TiAlN	HSS 8 TiCN	AK 20
PW90	90,0	3,5433"						●		●			
PW91	91,0	3,5827"					●	●		●			
PW92	92,0	3,6221"						●		●			
PW93	93,0	3,6614"						●		●			
PW94	94,0	3,7008"						●		●			
PW95	95,0	3,7402"						●		●			
PW95.25	95,25	3,7500"								●			
PW96	96,0	3,7795"						●		●			
PW97	97,0	3,8189"						●		●			
PW98	98,0	3,8583"						●		●			
PW98.43	98,43	3,8725"	3 7/8							●			
PW99	99,0	3,8976"						●		●			
PW100	100,0	3,9370"	3 15/16					●		●			
PW101	101,0	3,9764"						●		●			
PW101.6	101,6	4,0000"	4							●			
PW102	102,0	4,0157"	4 1/64					●		●			
PW103	103,0	4,0551"						●		●			
PW104	104,0	4,0945"	4 3/32					●		●			
PW104.75	104,75	4,1240"	4 1/8							●			
PW105	105,0	4,1339"						●		●			
PW106	106,0	4,1732"						●		●			
PW107	107,0	4,2126"						●		●			
PW108	108,0	4,2520"						●		●			
PW109	109,0	4,2913"						●		●			
PW110	110,0	4,3307"						●		●			
PW111	111,0	4,3701"						●		●			
PW111.13	111,13	4,3752"					●			●			
PW112	112,0	4,4094"						●		●			
PW112.71	112,71	4,4374"	4 7/16							●			
PW113	113,0	4,4408"						●		●			
PW114	114,0	4,4882"						●		●			

● Hauptanwendung Main Application Applicazione principale	P		●	●		●							
	M		○	○		●							
○ Nebenanwendung Secondary application Applicazione secondaria	K												
	N												
	S									○			
	H												

Hinweis: Zwischenabmessungen, die hier nicht aufgeführt sind, schleifen und beschichten wir Ihnen ab 5 Stück ohne Mehrpreis!

Remark: Other none standard diameters are available upon request.

Attenzione: Misure non indicate sono disponibili senza incremento prezzo per minimo 5pz.

Halter und Zubehör / Holder accessories / Accessori corpi

Bezeichnung Designation Articolo	Passend zu Haltern der Serien Used on the holder series Utilizzati sui corpi serie	❶ Schnellkupplung Fast action coupling Attacco rapido	❷ Kühlmitteladapter Rotary coolant adapters Anello refrigerante	❸ Stützstange Solid steady bar Barra anti rotazione
2KDA	A - C - E - G	SK-2KDA	R-2KDA	SS-2KDA
3KDA	I - K - M	SK-3KDA	R-3KDA	SS-3KDA
4KDA	O - Q	SK-4KDA	R-4KDA	SS-4KDA
5KDA	S	SK-5KDA	R-5KDA	SS-5KDA
6KDA	U - W	SK-6KDA	R-6KDA	SS-6KDA

❶ Schnellkupplung

Fast action coupling
Attacco rapido

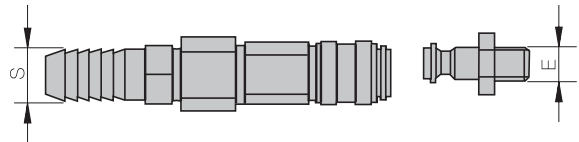

Bezeichnung Designation Articolo	Norm. Rohr-Gewinde E Norm pipe thread Filetto GAS	Schlauch- Ø S Hose Ø S Tubo Ø S
SK-2KDA	1/8"	9 mm
SK-3KDA	1/8"	9 mm
SK-4KDA	1/4"	9 mm
SK-5KDA	1/4"	12 mm
SK-6KDA	1/2"	12 mm

❷ Kühlmitteladapter

Rotary coolant adapter
Anello refrigerante

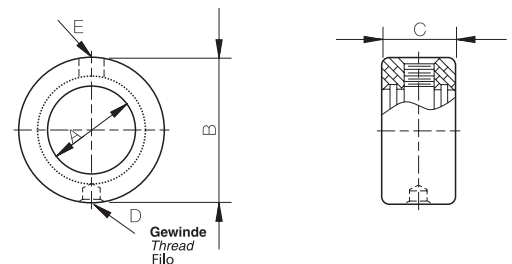

Bezeichnung Designation Articolo	A	B	C	D	E
R-2KDA	19,05	44,45	22,23	M8	1/8"
R-3KDA	25,40	53,97	28,57	M8	1/8"
R-4KDA	31,75	63,50	34,92	M10	1/4"
R-5KDA	44,45	76,20	34,92	M10	1/4"
R-6KDA	57,15	95,27	44,45	M12	1/2"

❸ Stützstange

Solid steady bar
Barra anti rotazione

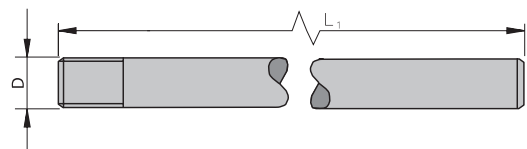

Bezeichnung Designation Articolo	Gewindegröße Thread size Filetto	L ₁ [mm]
SS-2KDA	M8	250
SS-3KDA	M8	250
SS-4KDA	M10	250
SS-5KDA	M10	250
SS-6KDA	M12	250

Schrauben und Schraubendreher / Screws and Screwdrivers / Chiavi e Viti

Bezeichnung Designation Articolo	für Ø-Bereich Drill Range used with Campo serie	Torx Schraubendreher Screwdriver Torx Chiave Torx	Anzugsmoment Torque Momento seraggio	Schrauben Screws Vite
A	9,5–11,0	T5107	0,6 Nm	AS 0011
C	11,5–12,8	T5107	0,6 Nm	AS 0011
E	13,0–17,5	T5108	1,3 Nm	AS 0012
G	15,5–17,5	T5108	1,3 Nm	AS 0018
I	17,8–24,0	T5109	2,2 Nm	AS 0013
K	22,0–24,0	T5109	2,2 Nm	AS 0019
M	24,5–35,0	T5115	5,1 Nm	AS 0014
O	30,0–35,0	T5115	5,1 Nm	AS 0014
Q	36,0–47,0	T5120	6,2 Nm	AS 0015
S	48,0–65,0	T5120	6,2 Nm	AS 0015
U	66,0–89,0	T5125	8,1 Nm	AS 0016
W	90,0–114,0	T5125	8,1 Nm	AS 0016

Hinweis: Drehmoment-Schraubendreher siehe Seite 281.

Remark: For torque screwdrivers see page 281.

Nota: Chiavi dinamometriche a pagina 281.



HSS-Einsätze

1

ISO	Werkstoff	Zugfestigkeit [N/mm ²]	Schnittgeschwindigkeit V _c									
			TTCN [m/min]	TAIN [m/min]	Serie A, C 9,5 – 12,53 [mm/U]	Serie E, G 12,98 – 17,93 [mm/U]	Serie I, K 17,53 – 24,38 [mm/U]	Serie M, O 24,41 – 35,00 [mm/U]	Serie Q 35,00 – 47,8 [mm/U]	Serie S 47,85 – 65,00 [mm/U]	Serie U, W 66,00 – 114,48 [mm/U]	
P	Automatenstähle z. B. 9SMn28; 9SMnPb28; 10SPb20	bis 500	80	86	0,18	0,25	0,33	0,41	0,51	0,58	0,7	
		500 - 850	64	73	0,15	0,25	0,33	0,41	0,51	0,58	0,7	
	Baustähle z. B. St33; St37-2; St44-2; St52; St60	350 - 500	55	60	0,15	0,25	0,3	0,35	0,45	0,52	0,65	
		500 - 850	45	51	0,13	0,23	0,25	0,3	0,4	0,47	0,6	
	Unlegierte und niedrig legierter Stahl beinhaltet auch Vergütungsstähle und Einsatzstähle z. B. C15; C22; 20Mn5; Ck45	850 - 1200	40	43	0,1	0,2	0,23	0,25	0,35	0,43	0,5	
		bis 450	64	74	0,15	0,23	0,3	0,38	0,47	0,58	0,7	
		450 - 750	60	70	0,13	0,2	0,25	0,36	0,45	0,52	0,6	
		750 - 900	55	65	0,13	0,2	0,25	0,36	0,45	0,52	0,6	
	Legierter Stahl z. B. 42CrMo4; 16MnCr5; 36CrNiMo4 14NiCrMo13-4; Ck75; Ck101; 17CrNiMo8; 35CrMo4; 41Cr4; 50MnSi4	900 - 1100	51	60	0,1	0,18	0,23	0,3	0,4	0,47	0,55	
		bis 600	60	65	0,15	0,2	0,25	0,36	0,42	0,47	0,55	
		600 - 800	55	60	0,13	0,2	0,25	0,36	0,42	0,47	0,55	
		800 - 950	51	55	0,13	0,18	0,25	0,36	0,42	0,47	0,55	
950 - 110		47	51	0,1	0,15	0,23	0,3	0,37	0,42	0,5		
Hochlegierter und hochfester Stahl z. B. 41CrAlMo7; 36CrNiMo4; 32NiCrMo14-5	1100 - 1250	45	48	0,08	0,15	0,23	0,3	0,37	0,42	0,5		
	600 - 1000	30	35	0,13	0,18	0,23	0,25	0,35	0,42	0,5		
	1000 - 1200	25	27	0,1	0,13	0,23	0,25	0,35	0,42	0,5		
Werkzeugstähle z. B. C75W; 102Cr6; 105WCr6; X153CrMoV12	1200 - 1350	20	22	0,08	0,11	0,2	0,23	0,3	0,4	0,45		
	500 - 700	32	35	0,1	0,15	0,2	0,25	0,3	0,35	0,41		
M	Nichtrostender Stahl und Stahlguss	austenitisch und austenitisch/ferritisch, abgeschreckt	700 - 950	25	28	0,1	0,15	0,2	0,25	0,3	0,35	0,41
		450 - 610	30	33	0,09	0,19	0,2	0,29	0,37	0,42	0,52	
K	Grauguss z. B. GG25; GG40	perlitisch, ferritisch	500 - 700	61	70	0,16	0,29	0,37	0,47	0,57	0,65	0,72
		perlitisch, martensitisch	700 - 850	45	50	0,14	0,19	0,24	0,3	0,37	0,44	0,52
	Gusseisen mit Kugelgraphit z. B. GGG50	ferritisch	850 - 1100	38	42	0,11	0,16	0,19	0,24	0,29	0,37	0,42
		perlitisch	540	50	57	0,16	0,22	0,3	0,4	0,45	0,5	0,6
Temperguss z. B. GTS70	ferritisch	450	50	57	0,16	0,22	0,3	0,4	0,45	0,5	0,6	
	perlitisch	780	45	50	0,13	0,17	0,22	0,28	0,35	0,45	0,5	
N	Aluminium-Knetlegierungen z. B. AlMgSiPb; AlCuMg1; AlMgSi1	nicht aushärtbar	200	210	250	0,12	0,17	0,28	0,34	0,56	0,65	0,65
		aushärtbar, ausgehärtet	335	125	140	0,2	0,34	0,4	0,45	0,57	0,65	0,65
	Aluminium-Gusslegierungen z. B. G-AlSi10Mg; G-ALSi12	≤ 12 % Si, ausgehärtet	250	200	240	0,2	0,33	0,41	0,48	0,56	0,64	0,64
		≤ 12 % Si, aushärtbar, ausgehärtet	300	160	190	0,2	0,33	0,41	0,48	0,56	0,64	0,64
		≤ 12 % Si, nicht aushärtbar	450	140	160	0,18	0,3	0,38	0,45	0,56	0,64	0,64
Kupfer und Kupferlegierungen (Bronze / Messing)	Automatenlegierung, Pb > 1 %	370	102	117	0,18	0,3	0,4	0,5	0,6	0,7	0,75	
	Messing, Rotguss	300	123	138	0,19	0,3	0,42	0,52	0,62	0,72	0,76	
	Aluminiumbronze	500	68	77	0,16	0,29	0,37	0,47	0,57	0,67	0,72	
	Kupfer und Elektrolytkupfer	200	46	51	0,06	0,09	0,16	0,21	0,26	0,36	0,41	
Nichtmetallische Werkstoffe	Duroplaste	Die Schnittwerte sind abhängig von der vorhandenen Kühlung. Startwerte wie bei Aluminium-Knetlegierungen (Luftkühlung ist empfohlen).										
	Faserverstärkte Kunststoffe											
	Hartgummi											
S	Warmfeste Legierungen / Superlegierungen z. B. Inconell, Hasteloy, Nimonic, Waspaloy, Monel	Fe-Basis gegläht	700	12	13	0,08	0,17	0,21	0,25	0,3	0,35	0,35
		Fe-Basis ausgehärtet	980	-	-	-	-	-	-	-	-	-
		Ni- oder Co-Basis gegläht	850	12	13	0,08	0,17	0,21	0,25	0,3	0,35	0,35
		Ni- oder Co-Basis gegossen ausgehärtet	1100	-	-	-	-	-	-	-	-	-
		1230	8	11	0,08	0,14	0,19	0,21	0,26	0,32	0,32	
Titanlegierungen z. B. Ti99,5; Ti Al6V4; TiCu2	Reintitan	500 - 700	13	15	0,09	0,19	0,21	0,25	0,31	0,37	0,4	
	700 - 1050	12	15	0,09	0,16	0,19	0,2	0,26	0,31	0,31		
H	Gehärteter Stahl	gehärtet und angelassen	1020 - 1365	22	30	0,09	0,16	0,2	0,24	0,3	0,42	0,47
		gehärtet und angelassen	1365 - 1850	13	15	0,06	0,13	0,19	0,2	0,26	0,3	0,4
	Hartguss	gegossen	1365	-	-	0,08	0,15	0,2	0,23	0,3	0,38	0,43
Gehärtetes Gusseisen	gehärtet und angelassen	2090	-	-	-	-	-	-	-	-	-	

Bitte beachten Sie, dass die nachfolgend genannten Werte als Richtwerte gelten und sich auf die Kühlmittelbedingungen, wie sie auf Seite 99 im Katalog „Bohrsystem SHARK-Drill“ beschrieben werden, beziehen. Wichtig ist auch, dass maschinenseitige Rahmenbedingungen als durchschnittlich bewertet werden können. Zur technischen Unterstützung wenden Sie sich bitte an unser Kompetenz-Team.

HM-Einsätze

ISO	Werkstoff	Zugfestigkeit [N/mm ²]	Schnittgeschwindigkeit V _c		Serie A, C 9,5–12,53 [mm/U]	Serie E, G 12,98–17,53 [mm/U]	Serie I, K 17,53–24,38 [mm/U]	Serie M, O 24,41–35,00 [mm/U]	Serie Q 35,00–47,8 [mm/U]	
			TiCN [m/min]	TiAlN [m/min]						
P	Automatenstähle z. B. 9SMn28; 9SMnPb28; 10SPb20	bis 500	115	125	0,15	0,21	0,28	0,35	0,43	
		500 - 850	90	105	0,13	0,21	0,28	0,35	0,43	
	Baustähle z. B. St33; St37-2; St44-2; St52; St60	350 - 500	85	95	0,13	0,21	0,26	0,3	0,38	
		500 - 850	68	75	0,11	0,2	0,21	0,26	0,34	
	Unlegierte und niedrig legierter Stahl beinhaltet auch Vergütungsstähle und Einsatzstähle z. B. C15; C22; 20Mn5; Ck45	850 - 1200	62	70	0,09	0,17	0,2	0,21	0,3	
		bis 450	110	120	0,13	0,2	0,26	0,32	0,4	
		450 - 750	85	95	0,11	0,17	0,21	0,31	0,38	
		750 - 900	70	85	0,11	0,17	0,21	0,31	0,38	
	Legierter Stahl z. B. 42CrMo4; 16MnCr5; 36CrNiMo4 14NiCrMo13-4; Ck75; Ck101; 17CrNiMo8; 35CrMo4; 41Cr4; 50MnSi4	900 - 1100	60	70	0,09	0,15	0,2	0,26	0,34	
		bis 600	90	100	0,13	0,17	0,21	0,31	0,36	
		600 - 800	80	90	0,11	0,17	0,21	0,31	0,36	
		800 - 950	70	85	0,11	0,15	0,21	0,31	0,36	
		950 - 110	67	75	0,09	0,13	0,2	0,26	0,31	
	Hochlegierter und hochfester Stahl z. B. 41CrAlMo7; 36CrNiMo4; 32NiCrMo14-5	1100 - 1250	60	65	0,07	0,13	0,2	0,26	0,31	
600 - 1000		55	60	0,11	0,15	0,2	0,21	0,3		
1000 - 1200		50	55	0,09	0,11	0,2	0,21	0,3		
Werkzeugstähle z. B. C75W; 102Cr6; 105WCr6; X153CrMoV12	1200 - 1350	44	50	0,07	0,09	0,17	0,2	0,26		
	500 - 700	60	65	0,09	0,13	0,17	0,21	0,26		
M	Nichtrostender Stahl und Stahlguss	austenitisch und austenitisch/ferritisch, abgeschreckt	500 - 700	60	65	0,09	0,13	0,17	0,21	0,26
		700 - 950	45	50	0,09	0,13	0,17	0,21	0,26	
K	Grauguss z. B. GG25; GG40	perlitisch, ferritisch	450 - 610	58	65	0,09	0,16	0,19	0,24	0,3
		perlitisch, martensitisch	610 - 930	44	50	0,09	0,14	0,16	0,2	0,25
	Gusseisen mit Kugelgraphit z. B. GGG50	ferritisch	500 - 700	103	123	0,14	0,2	0,26	0,37	0,45
		perlitisch	700 - 850	80	95	0,1	0,16	0,19	0,26	0,37
Temperguss z. B. GTS70	ferritisch	850 - 1100	70	84	0,1	0,14	0,16	0,22	0,32	
	perlitisch	540	100	120	0,12	0,17	0,2	0,29	0,45	
N	Aluminium-Knetlegierungen z. B. AlMgSiPb; AlCuMg1; AlMgSi1	ferritisch	850	75	95	0,1	0,14	0,18	0,26	0,37
		perlitisch	450	105	125	0,12	0,17	0,2	0,29	0,4
	Aluminium-Gusslegierungen z. B. G-AlSi10Mg; G-ALSi12	ferritisch	780	78	97	0,1	0,14	0,18	0,26	0,37
		perlitisch	200	410	450	0,1	0,17	0,27	0,33	0,38
	Kupfer und Kupferlegierungen (Bronze / Messing)	nicht aushärtbar	335	275	305	0,12	0,29	0,37	0,52	0,6
		aushärtbar, ausgehärtet	250	400	450	0,2	0,31	0,4	0,48	0,5
		≤ 12 % Si, ausgehärtet	300	350	380	0,2	0,3	0,4	0,48	0,5
		≤ 12 % Si, aushärtbar, ausgehärtet	450	250	280	0,18	0,28	0,36	0,46	0,48
	Nichtmetallische Werkstoffe	Automatenlegierung, Pb > 1 %	370	130	145	0,15	0,23	0,28	0,38	0,45
		Messing, Rotguss	300	160	185	0,16	0,24	0,29	0,39	0,45
Aluminiumbronze		500	100	110	0,14	0,2	0,26	0,37	0,42	
Kupfer und Elektrolytkupfer		200	100	120	0,05	0,09	0,1	0,16	0,25	
S	Warmfeste Legierungen / Superlegierungen z. B. Inconell, Hasteloy, Nimonic, Waspaloy, Monel	Duroplaste	Die Schnittwerte sind abhängig von der vorhandenen Kühlung. Startwerte wie bei Aluminium-Knetlegierungen (Luftkühlung ist empfohlen).							
		Faserverstärkte Kunststoffe								
		Hartgummi								
		Fe-Basis gegläht	700	29	32	0,08	0,16	0,2	0,24	0,3
		Fe-Basis ausgehärtet	980	-	-	-	-	-	-	-
	Ni- oder Co-Basis gegläht	850	29	32	0,08	0,16	0,2	0,24	0,3	
	Ni- oder Co-Basis gegossen ausgehärtet	1100	-	-	-	-	-	-	-	
Titanlegierungen z. B. Ti99,5; Ti Al6V4; TiCu2	1230	21	25	0,08	0,12	0,16	0,18	0,25		
H	Gehärteter Stahl	Reintitan	500 - 700	33	39	0,09	0,16	0,19	0,24	0,3
		700 - 1050	29	34	0,09	0,14	0,16	0,22	0,28	
	Hartguss	gehärtet und angelassen	1020 - 1365	40	44	0,09	0,14	0,22	0,25	0,32
		gehärtet und angelassen	1365 - 1850	24	26	0,06	0,11	0,16	0,22	0,27
Gehärtetes Gusseisen	gegossen	1365	30	35	0,07	0,12	0,18	0,22	0,27	
	gehärtet und angelassen	2090	-	-	-	-	-	-		

Bitte beachten Sie, dass die nachfolgend genannten Werte als Richtwerte gelten und sich auf die Kühlmittelbedingungen, wie sie auf Seite 99 im Katalog „Bohrsystem SHARK-Drill“ beschrieben werden, beziehen. Wichtig ist auch, dass maschinenseitige Rahmenbedingungen als durchschnittlich bewertet werden können. Zur technischen Unterstützung wenden Sie sich bitte an unser Kompetenz-Team.

Flachschneideinsätze

1

ISO	Werkstoff	Zugfestigkeit [N/mm ²]	Schnittgeschwindigkeit V _c		Serie A, C 9,5 – 12,53 [mm/U]	Serie E, G 12,98 – 17,53 [mm/U]	Serie I, K 17,53 – 24,38 [mm/U]	Serie M, O 24,41 – 35,00 [mm/U]	Serie Q 35,00 – 47,8 [mm/U]
			TiCN [m/min]	TiAlN [m/min]					
P	Automatenstähle z. B. 9SMn28; 9SMnPb28; 10SPb20	bis 500	–	69	0,14	0,2	0,26	0,33	0,41
		500 - 850	–	58	0,12	0,2	0,26	0,33	0,41
	Baustähle z. B. St33; St37-2; St44-2; St52; St60	350 - 500	–	48	0,12	0,2	0,24	0,28	0,36
		500 - 850	–	41	0,1	0,18	0,2	0,24	0,32
	Unlegierte und niedrig legierter Stahl beinhaltet auch Vergütungsstähle und Einsatzstähle z. B. C15; C22; 20Mn5; Ck45	850 - 1200	–	34	0,08	0,16	0,18	0,2	0,28
		bis 450	–	59	0,12	0,18	0,24	0,3	0,38
		450 - 750	–	56	0,1	0,16	0,2	0,29	0,36
		750 - 900	–	52	0,1	0,16	0,2	0,29	0,36
	Legierter Stahl z. B. 42CrMo4; 16MnCr5; 36CrNiMo4 14NiCrMo13-4; Ck75; Ck101; 17CrNiMo8; 35CrMo4; 41Cr4; 50MnSi4	900 - 1100	–	48	0,08	0,14	0,18	0,24	0,32
		bis 600	–	52	0,12	0,16	0,2	0,29	0,34
		600 - 800	–	48	0,1	0,16	0,2	0,29	0,34
		800 - 950	–	44	0,1	0,14	0,2	0,29	0,34
950 - 110		–	41	0,08	0,12	0,18	0,24	0,3	
Hochlegierter und hochfester Stahl z. B. 41CrAlMo7; 36CrNiMo4; 32NiCrMo14-5	1100 - 1250	–	38	0,06	0,12	0,18	0,24	0,3	
	600 - 1000	–	28	0,1	0,14	0,18	0,2	0,28	
	1000 - 1200	–	22	0,08	0,1	0,18	0,2	0,28	
Werkzeugstähle z. B. C75W; 102Cr6; 105WCr6; X153CrMoV12	1200 - 1350	–	18	0,06	0,09	0,16	0,18	0,24	
	500 - 700	–	28	0,08	0,12	0,16	0,2	0,24	
M	Nichtrostender Stahl und Stahlguss	austenitisch und austenitisch/ferritisch, abgeschreckt	500 - 700	–	28	0,08	0,12	0,16	0,2
		700 - 950	–	22	0,08	0,12	0,16	0,2	
K	Grauguss z. B. GG25; GG40	perlitisch, ferritisch	450 - 610	–	26	0,14	0,19	0,2	0,25
		610 - 930	–	23	0,1	0,15	0,19	0,22	0,25
	Gusseisen mit Kugelgraphit z. B. GGG50	perlitisch, martensitisch	500 - 700	–	60	0,14	0,24	0,3	0,42
		700 - 850	–	47	0,1	0,15	0,2	0,25	0,3
Temperguss z. B. GTS70	ferritisch	850 - 1100	–	38	0,1	0,12	0,15	0,2	0,25
		540	–	58	0,14	0,24	0,29	0,4	0,45
N	Aluminium-Knetlegierungen z. B. AlMgSiPb; AlCuMg1; AlMgSi1	ferritisch	850	–	47	0,1	0,16	0,19	0,24
		perlitisch	450	–	66	0,14	0,24	0,29	0,4
	Aluminium-Gusslegierungen z. B. G-ALSi10Mg; G-ALSi12	perlitisch	780	–	47	0,1	0,16	0,19	0,24
		nicht aushärtbar	200	–	230	0,18	0,29	0,37	0,44
	Kupfer und Kupferlegierungen (Bronze / Messing)	aushärtbar, ausgehärtet	335	–	120	0,19	0,29	0,37	0,42
		≤ 12 % Si, ausgehärtet	250	–	210	0,17	0,29	0,37	0,44
		≤ 12 % Si, aushärtbar, ausgehärtet	300	–	160	0,17	0,29	0,37	0,43
		≤ 12 % Si, nicht aushärtbar	450	–	120	0,17	0,29	0,37	0,42
	Nichtmetallische Werkstoffe	Automatenlegierung, Pb > 1 %	370	–	70	0,16	0,26	0,38	0,45
		Messing, Rotguss	300	–	68	0,15	0,25	0,37	0,44
Aluminiumbronze		500	–	60	0,14	0,24	0,3	0,42	
Kupfer und Elektrolytkupfer		200	–	45	0,06	0,09	0,16	0,2	
S	Warmfeste Legierungen / Superlegierungen z. B. Inconell, Hasteloy, Nimonic, Waspaloy, Monel	Duroplaste	Die Schnittwerte sind abhängig von der vorhandenen Kühlung. Startwerte wie bei Aluminium-Knetlegierungen (Luftkühlung ist empfohlen).						
		Faserverstärkte Kunststoffe							
		Hartgummi							
		Fe-Basis gegläht	700	–	10	0,08	0,14	0,17	0,22
		Fe-Basis ausgehärtet	980	–	–	–	–	–	–
	Ni- oder Co-Basis gegläht	850	–	9	0,08	0,13	0,15	0,19	
	Ni- oder Co-Basis gegossen ausgehärtet	1100	–	–	–	–	–	–	
Titanlegierungen z. B. Ti99,5; Ti Al6V4; TiCu2	1230	–	8	0,07	0,12	0,14	0,17		
H	Gehärteter Stahl	Reintitan	500 - 700	–	15	0,09	0,15	0,19	0,24
		700 - 1050	–	12	0,09	0,14	0,15	0,19	
	Hartguss	gehärtet und angelassen	1020 - 1365	–	20	0,09	0,14	0,19	0,24
		gehärtet und angelassen	1365 - 1850	–	13	0,09	0,1	0,15	0,19
Gehärtetes Gusseisen	gegossen	1365	–	18	0,09	0,12	0,16	0,19	
	gehärtet und angelassen	2090	–	–	–	–	–	–	

Bitte beachten Sie, dass die nachfolgend genannten Werte als Richtwerte gelten und sich auf die Kühlmittelbedingungen, wie sie auf Seite 99 im Katalog „Bohrsystem SHARK-Drill“ beschrieben werden, beziehen. Wichtig ist auch, dass maschinenseitige Rahmenbedingungen als durchschnittlich bewertet werden können. Zur technischen Unterstützung wenden Sie sich bitte an unser Kompetenz-Team.

ISO	Werkstoff	Kühlmittel Druck [bar] Volumen [Liter/min]	HSS-Einsatz							HM-Einsatz				
			Serie A, C 9,5–12,95	Serie E, G 12,98–17,53	Serie I, K 17,53–24,38	Serie M, O 24,41–35,00	Serie Q 35,00–47,80	Serie S 47,85–65,00	Serie U, W 66,00–114,48	Serie A, C 9,5–12,95	Serie E, G 12,98–17,53	Serie I, K 17,53–24,38	Serie M, O 24,41–35,00	Serie Q 35,00–47,80
P	Automatenstähle	[bar] [Liter/min]	12 10	6 10	7 16	6 27	5 45	3 114	3 144	12 10	7 11	7 17	7 30	7 60
	Baustähle	[bar] [Liter/min]	11 9	6 10	6 16	5 23	5 45	3 114	3 144	12 10	7 11	6 16	6 27	5 47
	Unlegierte und niedrig legierter Stahl beinhaltet auch Vergütungsstähle und Einsatzstähle	[bar] [Liter/min]	11 9	4 11	4 12	2 19	2 30	2 87	2 98	11 9	4 10	4 12	4 19	3 40
	Legierter Stahl	[bar] [Liter/min]	12 9	6 10	5 14	4 23	4 38	2 98	2 117	15 11	10 13	10 22	9 34	7,5 56
	Hochlegierter und hochfester Stahl	[bar] [Liter/min]	11 9	5 8	4 12	2 20	2 30	2 87	2 98	15 11	5 12	4 13	4 20	3 40
	Werkzeugstähle	[bar] [Liter/min]	11 10	4 8	4 12	3 20	2 30	2 87	2 98	15 11	5 12	4 13	3 20	3 37
M	Nichtrostender Stahl und Stahlguss	[bar] [Liter/min]	12 10	6 10	5 14	4 23	4 38	2 98	2 117	15 11	10 13	10 22	9 34	9 70
K	Grauguss	[bar] [Liter/min]	11 9	5 9	4 13	3 19	2 34	2 98	2 106	11 9	5 9	5 12	5 19	4 49
	Gusseisen mit Kugelgraphit	[bar] [Liter/min]	11 9	5 9	4 13	3 19	2 34	2 98	2 106	11 9	5 9	5 12	5 19	4 49
	Temperguss	[bar] [Liter/min]	11 9	5 9	4 13	3 19	2 34	2 98	2 106	11 9	5 9	5 13	5 19	4 49
N	Aluminium-Knetlegierungen	[bar] [Liter/min]	15 10	12 14	16 23	11 34	9 61	4 125	4 159	22 13	19 17	19 28	17 45	14 77
	Aluminium-Gusslegierungen	[bar] [Liter/min]	15 10	12 14	16 23	11 34	9 61	4 125	4 159	22 13	19 17	19 28	17 45	14 77
	Kupfer und Kupferlegierungen (Bronze / Messing)	[bar] [Liter/min]	13 10	8 11	10 20	8 30	7 53	4 125	4 167	14 10	10 13	10 21	10 34	10 75
	Nichtmetallische Werkstoffe	[bar] [Liter/min]	Luftkühlung ist empfohlen.											
S	Warmfeste Legierungen	[bar] [Liter/min]	11 9	4 11	4 12	2 19	2 30	2 87	2 98	18 10	11 11	10 12	10 19	9 62
	Titanlegierungen	[bar] [Liter/min]	11 9	5 9	4 12	2 19	2 30	2 98	2 125	18 10	11 11	10 16	10 27	9 62
H	Gehärteter Stahl	[bar] [Liter/min]	11 9	4 11	4 12	2 19	2 30	2 87	2 98	11 9	4 10	4 12	3 19	3 37
	Hartguss	[bar] [Liter/min]	11 9	4 11	4 12	2 19	2 30	2 87	2 98	11 9	4 10	4 12	3 19	3 37
	Gehärtetes Gusseisen	[bar] [Liter/min]	- -	- -	- -	- -	- -	- -	- -	- -	- -	- -	- -	- -

Diese Empfehlungen ermöglichen optimale Standzeiten und Spanabfuhr. Bei geringeren Werten müssen Verschleiß und Spanentwicklung beobachtet werden und gegebenenfalls die Schnittwerte angepasst werden.

Hinweis: Die Kühlmittelangaben gelten bis ca. 8xD Bohrtiefe.

Bei 8–12xD multiplizieren Sie die Werte mit 1,3. Bei 12–20xD mit 2,0. Über 20xD bitte mit 3,0 multiplizieren.



HSS inserts

1

ISO	Material	Tensile strength [N/mm ²]	Cutting speed V _c		Series A, C 9.5 – 12.53 [mm/rev]	Series E, G 12.98 – 17.53 [mm/rev]	Series I, K 17.53 – 24.38 [mm/rev]	Series M, O 24.41 – 35.00 [mm/rev]	Series Q 35.00 – 47.8 [mm/rev]	Series S 47.85 – 66.00 [mm/rev]	Series U, W 66.00 – 114.48 [mm/rev]	
			TiCN [m/min]	TiAlN [m/min]								
P	Unalloyed steel and cast steel e. G. 9SMn28; 9SMnPb28; 10SPb20	up to 500	80	86	0.18	0.25	0.33	0.41	0.51	0.58	0.7	
		500 - 850	64	73	0.15	0.25	0.33	0.41	0.51	0.58	0.7	
	Structural steel e. G. St33; St37-2; St44-2; St52; St60	350 - 500	55	60	0.15	0.25	0.3	0.35	0.45	0.52	0.65	
		500 - 850	45	51	0.13	0.23	0.25	0.3	0.4	0.47	0.6	
	None- and low alloy steel as well as carbon steel and case hardened steel e. G. C15; C22; 20Mn5; Ck45	850 - 1200	40	43	0.1	0.2	0.23	0.25	0.35	0.43	0.5	
		bis 450	64	74	0.15	0.23	0.3	0.38	0.47	0.58	0.7	
		450 - 750	60	70	0.13	0.2	0.25	0.36	0.45	0.52	0.6	
		750 - 900	55	65	0.13	0.2	0.25	0.36	0.45	0.52	0.6	
	Alloys steel e. G. 42CrMo4; 16MnCr5; 36CrNiMo4 14NiCrMo13-4; Ck75; Ck101; 17CrNiMo8; 35CrMo4; 41Cr4; 50MnSi4	900 - 1100	51	60	0.1	0.18	0.23	0.3	0.4	0.47	0.55	
		bis 600	60	65	0.15	0.2	0.25	0.36	0.42	0.47	0.55	
		600 - 800	55	60	0.13	0.2	0.25	0.36	0.42	0.47	0.55	
		800 - 950	51	55	0.13	0.18	0.25	0.36	0.42	0.47	0.55	
950 - 110		47	51	0.1	0.15	0.23	0.3	0.37	0.42	0.5		
High alloys steel e. G. 41CrAlMo7; 36CrNiMo4; 32NiCrMo14-5	1100 - 1250	45	48	0.08	0.15	0.23	0.3	0.37	0.42	0.5		
	600 - 1000	30	35	0.13	0.18	0.23	0.25	0.35	0.42	0.5		
	1000 - 1200	25	27	0.1	0.13	0.23	0.25	0.35	0.42	0.5		
Tool steel e. G. C75W; 102Cr6; 105WCr6; X153CrMoV12	1200 - 1350	20	22	0.08	0.11	0.2	0.23	0.3	0.4	0.45		
	500 - 700	32	35	0.1	0.15	0.2	0.25	0.3	0.35	0.41		
M	Stainless steel and cast steel	austenitic and austenitic/ferritic	450 - 610	30	33	0.09	0.19	0.2	0.29	0.37	0.42	0.52
		chilled	610 - 930	25	29	0.09	0.16	0.19	0.25	0.3	0.37	0.47
K	Cast iron e. G. GG25; GG40	pearlitic, ferritic	500 - 700	61	70	0.16	0.29	0.37	0.47	0.57	0.65	0.72
		pearlitic, martensitic	700 - 850	45	50	0.14	0.19	0.24	0.3	0.37	0.44	0.52
	Cast iron with nodular graphite e. G. GGG50	ferritic	540	50	57	0.16	0.22	0.3	0.4	0.45	0.5	0.6
		pearlitic	850	45	50	0.13	0.17	0.22	0.28	0.35	0.45	0.5
Malleable cast iron e. G. GTS70	ferritic	450	50	57	0.16	0.22	0.3	0.4	0.45	0.5	0.6	
	pearlitic	780	45	50	0.13	0.17	0.22	0.28	0.35	0.45	0.5	
N	Aluminium alloys, long chipping e. G. AlMgSiPb; AlCuMg1; AMgSi1	not heat treatable	200	210	250	0.12	0.17	0.28	0.34	0.56	0.65	0.65
		heat treatable, heat-treated	335	125	140	0.2	0.34	0.4	0.45	0.57	0.65	0.65
	Casted aluminium alloys e. G. G-AlSi10Mg; G-ALSi12	≤ 12 % Si, hardened	250	200	240	0.2	0.33	0.41	0.48	0.56	0.64	0.64
		≤ 12 % Si, heat treatable, hardened	300	160	190	0.2	0.33	0.41	0.48	0.56	0.64	0.64
		≤ 12 % Si, not heat treatable	450	140	160	0.18	0.3	0.38	0.45	0.56	0.64	0.64
	Copper and copper alloys (brass / bronze)	Lead alloys, Pb > 1 %	370	102	117	0.18	0.3	0.4	0.5	0.6	0.7	0.75
Brass, bronze		300	123	138	0.19	0.3	0.42	0.52	0.62	0.72	0.76	
Aluminium bronze		500	68	77	0.16	0.29	0.37	0.47	0.57	0.67	0.72	
Copper and electrolyte copper		200	46	51	0.06	0.09	0.16	0.21	0.26	0.36	0.41	
Non-ferrous materials	Duroplastics	The cutting datas are depending on the available coolant supply. Starting datas are the same as aluminium alloys, long chipping. Air coolant is recommended.										
	Re- inforced plastics											
	Hard rubber											
S	High temperature resistant alloys e. G. Inconell, Hasteloy, Nimonic, Waspaloy, Monel	Fe-alloyed annealed	700	12	13	0.08	0.17	0.21	0.25	0.3	0.35	0.35
		heat - treated	980	-	-	-	-	-	-	-	-	-
		Ni- or annealed	850	12	13	0.08	0.17	0.21	0.25	0.3	0.35	0.35
		Co based casting	1100	-	-	-	-	-	-	-	-	-
		heat - treated	1230	8	11	0.08	0.14	0.19	0.21	0.26	0.32	0.32
Titanium alloys / Titan e. G. Ti99,5; Ti Al6V4; TiCu2	Pure titan	500 - 700	13	15	0.09	0.19	0.21	0.25	0.31	0.37	0.4	
H	Hardened steel	700 - 1050	12	15	0.09	0.16	0.19	0.2	0.26	0.31	0.31	
		1365 - 1365	22	30	0.09	0.16	0.2	0.24	0.3	0.42	0.47	
	1365 - 1850	13	15	0.06	0.13	0.19	0.2	0.26	0.3	0.4		
	Hard cast iron	casting	1365	-	-	0.08	0.15	0.2	0.23	0.3	0.38	0.43
Hardened cast iron	hardened and tempered	2090	-	-	-	-	-	-	-	-		

Please note that the recommended cutting datas are a starting reference point in combination with the coolant figures on page 103 in the catalogue "Drillsystem SHARK-Drill®". Also important is that the basic conditions are on an average. For technical support please contact our application engineers.

Carbide inserts

ISO	Material	Tensile strength [N/mm ²]	Cutting speed V _c		Serie A, C 9.5 – 12.53 [mm/rev]	Serie E, G 12.98 – 17.53 [mm/rev]	Serie I, K 17.53 – 24.38 [mm/rev]	Serie M, O 24.41 – 35.00 [mm/rev]	Serie Q 35.00 – 47.8 [mm/rev]
			TiCN [m/min]	TiAlN [m/min]					
P	Unalloyed steel and cast steel e. G. 9SMn28; 9SMnPb28; 10SPb20	up to 500	115	125	0.15	0.21	0.28	0.35	0.43
		500 - 850	90	105	0.13	0.21	0.28	0.35	0.43
	Structural steel e. G. St33; St37-2; St44-2; St52; St60	350 - 500	85	95	0.13	0.21	0.26	0.3	0.38
		500 - 850	68	75	0.11	0.2	0.21	0.26	0.34
	None- and low alloy steel as well as carbon steel and case hardened steel e. G. C15; C22; 20Mn5; Ck45	850 - 1200	62	70	0.09	0.17	0.2	0.21	0.3
		bis 450	110	120	0.13	0.2	0.26	0.32	0.4
		450 - 750	85	95	0.11	0.17	0.21	0.31	0.38
		750 - 900	70	85	0.11	0.17	0.21	0.31	0.38
	Alloys steel e. G. 42CrMo4; 16MnCr5; 36CrNiMo4 14NiCrMo13-4; Ck75; Ck101; 17CrNiMo8; 35CrMo4; 41Cr4; 50MnSi4	900 - 1100	60	70	0.09	0.15	0.2	0.26	0.34
		bis 600	90	100	0.13	0.17	0.21	0.31	0.36
		600 - 800	80	90	0.11	0.17	0.21	0.31	0.36
		800 - 950	70	85	0.11	0.15	0.21	0.31	0.36
		950 - 110	67	75	0.09	0.13	0.2	0.26	0.31
	High alloys steel e. G. 41CrAlMo7; 36CrNiMo4; 32NiCrMo14-5	1100 - 1250	60	65	0.07	0.13	0.2	0.26	0.31
600 - 1000		55	60	0.11	0.15	0.2	0.21	0.3	
1000 - 1200		50	55	0.09	0.11	0.2	0.21	0.3	
Tool steel e. G. C75W; 102Cr6; 105WCr6; X153CrMoV12	1200 - 1350	44	50	0.07	0.09	0.17	0.2	0.26	
	500 - 700	60	65	0.09	0.13	0.17	0.21	0.26	
M	Stainless steel and cast steel	austenitic and austenitic/ferritic	500 - 700	60	65	0.09	0.13	0.17	0.21
		chilled	700 - 950	45	50	0.09	0.13	0.17	0.21
K	Cast iron e. G. GG25; GG40	pearlitic, ferritic	450 - 610	58	65	0.09	0.16	0.19	0.24
		chilled	610 - 930	44	50	0.09	0.14	0.16	0.2
	Cast iron with nodular graphite e. G. GGG50	pearlitic, ferritic	500 - 700	103	123	0.14	0.2	0.26	0.37
		pearlitic, martensitic	700 - 850	80	95	0.1	0.16	0.19	0.26
Malleable cast iron e. G. GTS70	ferritic	850 - 1100	70	84	0.1	0.14	0.16	0.22	
	pearlitic	540	100	120	0.12	0.17	0.2	0.29	
N	Aluminium alloys, long chipping e. G. AlMgSiPb; AlCuMg1; AlMgSi1	ferritic	850	75	95	0.1	0.14	0.18	0.26
		pearlitic	450	105	125	0.12	0.17	0.2	0.29
	Casted aluminium alloys e. G. G-AlSi10Mg; G-ALSi12	ferritic	450	78	97	0.1	0.14	0.18	0.26
		pearlitic	780	78	97	0.1	0.14	0.18	0.26
	Non-ferrous materials	not heat treatable	200	410	450	0.1	0.17	0.27	0.33
		heat treatable, heat-treated	335	275	305	0.12	0.29	0.37	0.52
		≤ 12 % Si, hardened	250	400	450	0.2	0.31	0.4	0.48
		≤ 12 % Si, heat treatable, hardened	300	350	380	0.2	0.3	0.4	0.48
	Copper and copper alloys (brass / bronze)	≤ 12 % Si, not heat treatable	450	250	280	0.18	0.28	0.36	0.46
		Lead alloys, Pb > 1 %	370	130	145	0.15	0.23	0.28	0.38
Brass, bronze		300	160	185	0.16	0.24	0.29	0.39	
Aluminium bronze		500	100	110	0.14	0.2	0.26	0.37	
S	High temperature resistant alloys e. G. Inconell, Hasteloy, Nimonic, Waspaloy, Monel	Copper and electrolyte copper	200	100	120	0.05	0.09	0.1	0.16
		Duroplastics	The cutting datas are depending on the available coolant supply. Starting datas are the same as aluminium alloys, long chipping. Air coolant is recommended.						
		Re- inforced plastics							
Hard rubber									
H	Hardened steel	Fe-alloyed annealed	700	29	32	0.08	0.16	0.2	0.24
		heat - treated	980	-	-	-	-	-	-
		Ni- or annealed	850	29	32	0.08	0.16	0.2	0.24
		Co based casting	1100	-	-	-	-	-	-
		heat - treated	1230	21	25	0.08	0.12	0.16	0.18
Titanium alloys / Titan e. G. Ti99,5; Ti Al6V4; TiCu2	Pure titan	500 - 700	33	39	0.09	0.16	0.19	0.24	
		700 - 1050	29	34	0.09	0.14	0.16	0.22	
Hard cast iron	hardened and tempered	1020 - 1365	40	44	0.09	0.14	0.22	0.25	
	hardened and tempered	1365 - 1850	24	26	0.06	0.11	0.16	0.22	
	casting	1365	30	35	0.07	0.12	0.18	0.22	
Hardened cast iron	hardened and tempered	2090	-	-	-	-	-	-	

Please note that the recommended cutting datas are a starting reference point in combination with the coolant figures on page 103 in the catalogue "Drillsystem SHARK-Drill®". Also important is that the basic conditions are on an average. For technical support please contact our application engineers.

Flat bottom inserts

ISO	Material	Tensile strength [N/mm ²]	Cutting speed V _c		Serie A, C 9.5–12.53 [mm/rev]	Serie E, G 12.98–17.53 [mm/rev]	Serie I, K 17.53–24.38 [mm/rev]	Serie M, O 24.41–35.00 [mm/rev]	Serie Q 35.00–47.8 [mm/rev]	
			TiCN [m/min]	TiAlN [m/min]						
P	Unalloyed steel and cast steel e. G. 9SMn28; 9SMnPb28; 10SPb20	up to 500	–	69	0.14	0.2	0.26	0.33	0.41	
		500 - 850	–	58	0.12	0.2	0.26	0.33	0.41	
	Structural steel e. G. St33; St37-2; St44-2; St52; St60	350 - 500	–	48	0.12	0.2	0.24	0.28	0.36	
		500 - 850	–	41	0.1	0.18	0.2	0.24	0.32	
	None- and low alloy steel as well as carbon steel and case hardened steel e. G. C15; C22; 20Mn5; Ck45	850 - 1200	–	34	0.08	0.16	0.18	0.2	0.28	
		bis 450	–	59	0.12	0.18	0.24	0.3	0.38	
		450 - 750	–	56	0.1	0.16	0.2	0.29	0.36	
		750 - 900	–	52	0.1	0.16	0.2	0.29	0.36	
	Alloys steel e. G. 42CrMo4; 16MnCr5; 36CrNiMo4 14NiCrMo13-4; Ck75; Ck101; 17CrNiMo8; 35CrMo4; 41Cr4; 50MnSi4	900 - 1100	–	48	0.08	0.14	0.18	0.24	0.32	
		bis 600	–	52	0.12	0.16	0.2	0.29	0.34	
		600 - 800	–	48	0.1	0.16	0.2	0.29	0.34	
		800 - 950	–	44	0.1	0.14	0.2	0.29	0.34	
		950 - 110	–	41	0.08	0.12	0.18	0.24	0.3	
	High alloys steel e. G. 41CrAlMo7; 36CrNiMo4; 32NiCrMo14-5	1100 - 1250	–	38	0.06	0.12	0.18	0.24	0.3	
600 - 1000		–	28	0.1	0.14	0.18	0.2	0.28		
1000 - 1200		–	22	0.08	0.1	0.18	0.2	0.28		
Tool steel e. G. C75W; 102Cr6; 105WCr6; X153CrMoV12	1200 - 1350	–	18	0.06	0.09	0.16	0.18	0.24		
	500 - 700	–	28	0.08	0.12	0.16	0.2	0.24		
M	Stainless steel and cast steel	austenitic and austenitic/ferritic	–	26	0.14	0.19	0.2	0.25	0.29	
		chilled	–	23	0.1	0.15	0.19	0.22	0.25	
K	Cast iron e. G. GG25; GG40	pearlitic, ferritic	–	60	0.14	0.24	0.3	0.42	0.46	
		pearlitic, martensitic	–	47	0.1	0.15	0.2	0.25	0.3	
		850 - 1100	–	38	0.1	0.12	0.15	0.2	0.25	
	Cast iron with nodular graphite e. G. GGG50	ferritic	–	58	0.14	0.24	0.29	0.4	0.45	
pearlitic		–	47	0.1	0.16	0.19	0.24	0.3		
Malleable cast iron e. G. GTS70	ferritic	–	66	0.14	0.24	0.29	0.4	0.45		
	pearlitic	–	47	0.1	0.16	0.19	0.24	0.3		
N	Aluminium alloys, long chipping e. G. AlMgSiPb; AlCuMg1; AlMgSi1	not heat treatable	–	230	0.18	0.29	0.37	0.44	0.5	
		heat treatable, heat-treated	–	120	0.19	0.29	0.37	0.42	0.45	
	Casted aluminium alloys e. G. G-AlSi10Mg; G-ALSi12	≤ 12 % Si, hardened	–	250	0.17	0.29	0.37	0.44	0.5	
		≤ 12 % Si, heat treatable, hardened	–	300	0.17	0.29	0.37	0.43	0.47	
		≤ 12 % Si, not heat treatable	–	450	0.17	0.29	0.37	0.42	0.45	
Copper and copper alloys (brass / bronze)	Lead alloys, Pb > 1 %	–	370	0.16	0.26	0.38	0.45	0.5		
	Brass, bronze	–	300	0.15	0.25	0.37	0.44	0.49		
	Aluminium bronze	–	500	0.14	0.24	0.3	0.42	0.45		
	Copper and electrolyte copper	–	200	0.06	0.09	0.16	0.2	0.3		
Non-ferrous materials	Duroplastics	The cutting datas are depending on the available coolant supply. Starting datas are the same as aluminium alloys, long chipping. Air coolant is recommended.								
	Re- inforced plastics									
	Hard rubber									
S	High temperature resistant alloys e. G. Inconell, Hasteloy, Nimonic, Waspaloy, Monel	Fe-alloyed annealed	–	10	0.08	0.14	0.17	0.22	0.27	
		heat - treated	–	980	–	–	–	–	–	
		Ni- or annealed	–	850	–	9	0.08	0.13	0.15	0.19
		Co based casting	–	1100	–	–	–	–	–	
	Titanium alloys / Titan e. G. Ti99,5; Ti Al6V4; TiCu2	heat - treated	–	1230	–	8	0.07	0.12	0.14	0.17
H	Hardened steel	Pure titan	–	500 - 700	–	15	0.09	0.15	0.19	0.24
		700 - 1050	–	12	0.09	0.14	0.15	0.19	0.23	
	Hard cast iron	hardened and tempered	–	1020 - 1365	–	20	0.09	0.14	0.19	0.24
		hardened and tempered	–	1365 - 1850	–	13	0.09	0.1	0.15	0.19
Hardened cast iron	casting	–	1365	–	18	0.09	0.12	0.16	0.19	
	hardened and tempered	–	2090	–	–	–	–	–	–	

Please note that the recommended cutting datas are a starting reference point in combination with the coolant figures on page 103 in the catalogue "Drillsystem SHARK-Drill®". Also important is that the basic conditions are on an average. For technical support please contact our application engineers.

ISO	Material	Coolant pressure [bar] flow rate [litre/min]	HSS inserts							HM inserts				
			Series A, C 9.5–12.95	Series E, G 12.98–17.53	Series I, K 17.53–24.38	Series M, O 24.41–35.00	Series Q 35.00–47.80	Series S 47.85–65.00	Series U, W 66.00–114.48	Series A, C 9.5–12.95	Series E, G 12.98–17.53	Series I, K 17.53–24.38	Series M, O 24.41–35.00	Series Q 35.00–47.80
P	Unalloyed steel and cast steel	[bar]	12	6	7	6	5	3	3	12	7	7	7	7
		[litre/min]	10	10	16	27	45	114	144	10	11	17	30	60
	Structural steel	[bar]	11	6	6	5	5	3	3	12	7	6	6	5
		[litre/min]	9	10	16	23	45	114	144	10	11	16	27	47
	None- and low alloy steel as well as carbon steel and case hardened steel	[bar]	11	4	4	2	2	2	2	11	4	4	4	3
		[litre/min]	9	11	12	19	30	87	98	9	10	12	19	40
Alloys steel	[bar]	12	6	5	4	4	2	2	15	10	10	9	7.5	
	[litre/min]	9	10	14	23	38	98	117	11	13	22	34	56	
High alloys steel	[bar]	11	5	4	2	2	2	2	15	5	4	4	3	
	[litre/min]	9	8	12	20	30	87	98	11	12	13	20	40	
Tool steel	[bar]	11	4	4	3	2	2	2	15	5	4	3	3	
	[litre/min]	10	8	12	20	30	87	98	11	12	13	20	37	
M	Stainless steel and cast steel	[bar]	12	6	5	4	4	2	2	15	10	10	9	9
		[litre/min]	10	10	14	23	38	98	117	11	13	22	34	70
K	Cast iron	[bar]	11	5	4	3	2	2	2	11	5	5	5	4
		[litre/min]	9	9	13	19	34	98	106	9	9	12	19	49
	Cast iron with nodular graphite	[bar]	11	5	4	3	2	2	2	11	5	5	5	4
[litre/min]		9	9	13	19	34	98	106	9	9	12	19	49	
Malleable cast iron	[bar]	11	5	4	3	2	2	2	11	5	5	5	4	
	[litre/min]	9	9	13	19	34	98	106	9	9	13	19	49	
N	Aluminium alloys, long chipping	[bar]	15	12	16	11	9	4	4	22	19	19	17	14
		[litre/min]	10	14	23	34	61	125	159	13	17	28	45	77
	Casted aluminium alloys	[bar]	15	12	16	11	9	4	4	22	19	19	17	14
		[litre/min]	10	14	23	34	61	125	159	13	17	28	45	77
	Copper and copper alloys (brass / bronze)	[bar]	13	8	10	8	7	4	4	14	10	10	10	10
[litre/min]		10	11	20	30	53	125	167	10	13	21	34	75	
Non-ferrous materials	[bar] [litre/min]	Air coolant is recommended.												
S	High temperature resistant alloys	[bar]	11	4	4	2	2	2	2	18	11	10	10	9
		[litre/min]	9	11	12	19	30	87	98	10	11	12	19	62
Titanium alloys / Titan	[bar]	11	5	4	2	2	2	2	18	11	10	10	9	
	[litre/min]	9	9	12	19	30	98	125	10	11	16	27	62	
H	Hardened steel	[bar]	11	4	4	2	2	2	2	11	4	4	3	3
		[litre/min]	9	11	12	19	30	87	98	9	10	12	19	37
	Hard cast iron	[bar]	11	4	4	2	2	2	2	11	4	4	3	3
		[litre/min]	9	11	12	19	30	87	98	9	10	12	19	37
Hardened cast iron	[bar] [litre/min]	-	-	-	-	-	-	-	-	-	-	-	-	

These recommendations produce optimum tool life and chip evacuation. With lower values, wear and chip evacuation should receive attention. If necessary the speeds and feeds must be reduced.

Information: Please note that the coolant figures are recommendations for a drilling depth to 8xD. With longer drills multiply the recommended data as follows; 8 to 12xD multiply by 1.3; 12 to 20xD multiply by 2.0; over 20xD multiply by 3.0

Inserti HSS

ISO	Materiale	Carico di rottura [N/mm ²]	Velocità di taglio V _c		Serie A, C 9,5 - 12,53 [mm/giro]	Serie E, G 12,98 - 17,53 [mm/giro]	Serie I, K 17,53 - 24,38 [mm/giro]	Serie M, O 24,41 - 35,00 [mm/giro]	Serie Q 35,00 - 47,8 [mm/giro]	Serie S 47,85 - 65,00 [mm/giro]	Serie U, W 66,00 - 114,48 [mm/giro]	
			TTCN [m/min]	TAIN [m/min]								
P	Acciaio non legato o da fusione p. e. 9SMn28; 9SMnPb28; 10SPb20	fino a 500	80	86	0,18	0,25	0,33	0,41	0,51	0,58	0,7	
		500 - 850	64	73	0,15	0,25	0,33	0,41	0,51	0,58	0,7	
	Acciaio da costruzione p. e. St33; St37-2; St44-2; St52; St60	350 - 500	55	60	0,15	0,25	0,3	0,35	0,45	0,52	0,65	
		500 - 850	45	51	0,13	0,23	0,25	0,3	0,4	0,47	0,6	
	Acciaio non legato o debolmente legato, acciaio al carbonio o acciaio stampato p. e. C15; C22; 20Mn5; Ck45	850 - 1200	40	43	0,1	0,2	0,23	0,25	0,35	0,43	0,5	
		bis 450	64	74	0,15	0,23	0,3	0,38	0,47	0,58	0,7	
		450 - 750	60	70	0,13	0,2	0,25	0,36	0,45	0,52	0,6	
		750 - 900	55	65	0,13	0,2	0,25	0,36	0,45	0,52	0,6	
	Acciaio legato p. e. 42CrMo4; 16MnCr5; 36CrNiMo4 14NiCrMo13-4; Ck75; Ck101; 17CrNiMo8; 35CrMo4; 41Cr4; 50MnSi4	900 - 1100	51	60	0,1	0,18	0,23	0,3	0,4	0,47	0,55	
		bis 600	60	65	0,15	0,2	0,25	0,36	0,42	0,47	0,55	
		600 - 800	55	60	0,13	0,2	0,25	0,36	0,42	0,47	0,55	
		800 - 950	51	55	0,13	0,18	0,25	0,36	0,42	0,47	0,55	
950 - 110		47	51	0,1	0,15	0,23	0,3	0,37	0,42	0,5		
Acciaio fortemente legato p. e. 41CrAlMo7; 36CrNiMo4; 32NiCrMo14-5	1100 - 1250	45	48	0,08	0,15	0,23	0,3	0,37	0,42	0,5		
	600 - 1000	30	35	0,13	0,18	0,23	0,25	0,35	0,42	0,5		
	1000 - 1200	25	27	0,1	0,13	0,23	0,25	0,35	0,42	0,5		
Acciaio da utensili p. e. C75W; 102Cr6; 105WCr6; X153CrMoV12	1200 - 1350	20	22	0,08	0,11	0,2	0,23	0,3	0,4	0,45		
	500 - 700	32	35	0,1	0,15	0,2	0,25	0,3	0,35	0,41		
M	Acciaio inossidabile ed acciaio da fusione	austenitico e austenitico/ferritico	450 - 610	30	33	0,09	0,19	0,2	0,29	0,37	0,42	0,52
		temprato	610 - 930	25	29	0,09	0,16	0,19	0,25	0,3	0,37	0,47
K	Ghisa p. e. GG25; GG40	perlitica, ferritica	500 - 700	61	70	0,16	0,29	0,37	0,47	0,57	0,65	0,72
		perlitica, martensitica	700 - 850	45	50	0,14	0,19	0,24	0,3	0,37	0,44	0,52
			850 - 1100	38	42	0,11	0,16	0,19	0,24	0,29	0,37	0,42
K	Ghisa grigia sferoidale p. e. GGG50	ferritica	540	50	57	0,16	0,22	0,3	0,4	0,45	0,5	0,6
		perlitica	850	45	50	0,13	0,17	0,22	0,28	0,35	0,45	0,5
K	Ghisa malleabile p. e. GTS70	ferritica	450	50	57	0,16	0,22	0,3	0,4	0,45	0,5	0,6
		perlitica	780	45	50	0,13	0,17	0,22	0,28	0,35	0,45	0,5
N	Leghe di Alluminio a truciolo lungo p. e. AlMgSiPb; AlCuMgLi; AMgSi1	non temprabile	200	210	250	0,12	0,17	0,28	0,34	0,56	0,65	0,65
		temprabile, temprato	335	125	140	0,2	0,34	0,4	0,45	0,57	0,65	0,65
	Leghe di Alluminio da getti p. e. G-AlSi10Mg; G-ALSi12	≤ 12 % Si, temprato	250	200	240	0,2	0,33	0,41	0,48	0,56	0,64	0,64
		≤ 12 % Si, temprabile, temprato	300	160	190	0,2	0,33	0,41	0,48	0,56	0,64	0,64
		≤ 12 % Si, non temprabile	450	140	160	0,18	0,3	0,38	0,45	0,56	0,64	0,64
	Rame e leghe di rame (ottone / bronzo)	Legate al piombo, Pb > 1 %	370	102	117	0,18	0,3	0,4	0,5	0,6	0,7	0,75
Ottone / Bronzo		300	123	138	0,19	0,3	0,42	0,52	0,62	0,72	0,76	
Bronzo alluminio		500	68	77	0,16	0,29	0,37	0,47	0,57	0,67	0,72	
Rame e rame elettrolitico		200	46	51	0,06	0,09	0,16	0,21	0,26	0,36	0,41	
Materiali non ferrosi	Plastiche dure	I parametri di taglio dipendono dalla quantità di refrigerante disponibile. Come parametri di partenza utilizzare dati per leghe di alluminio a truciolo lungo.										
	Plastiche rinforzate											
	Gomme dure											
S	Leghe esotiche resistenti alle alte temperature p. e. Inconell, Hasteloy, Nimonic, Waspaloy, Monel	Fe-legate ricotto	700	12	13	0,08	0,17	0,21	0,25	0,3	0,35	0,35
		temprato	980	-	-	-	-	-	-	-	-	-
		Ni o ricotto	850	12	13	0,08	0,17	0,21	0,25	0,3	0,35	0,35
		Co legato stampato	1100	-	-	-	-	-	-	-	-	-
		temprato	1230	8	11	0,08	0,14	0,19	0,21	0,26	0,32	0,32
Leghe di titanio, Titanio p. e. Ti99,5; Ti Al6V4; TiCu2	Titanio puro	500 - 700	13	15	0,09	0,19	0,21	0,25	0,31	0,37	0,4	
		700 - 1050	12	15	0,09	0,16	0,19	0,2	0,26	0,31	0,31	
H	Acciaio temprato	temprato	1020 - 1365	22	30	0,09	0,16	0,2	0,24	0,3	0,42	0,47
		temprato	1365 - 1850	13	15	0,06	0,13	0,19	0,2	0,26	0,3	0,4
	Ghisa temprata	stampato	1365	-	-	0,08	0,15	0,2	0,23	0,3	0,38	0,43
	Ghisa temprata	temprato	2090	-	-	-	-	-	-	-	-	-

I parametri di taglio indicati sono da considerarsi come valori massimi ed in ottimali condizioni di lavoro (stabilità sistema, qualità e pressione refrigerante, buona truciolabilità del materiale). Combinare a questi parametri di taglio gli accorgimenti relativi al refrigerante riportati a pagina 107. Per ulteriore supporto tecnico contattare i tecnici ARNO.

Inserti in metallo duro

ISO	Materiale	Carico di rottura [N/mm²]	Velocità di taglio V _c		Serie A, C 9,5-12,53 [mm/giro]	Serie E, G 12,98-17,53 [mm/giro]	Serie I, K 17,53-24,38 [mm/giro]	Serie M, O 24,41-35,00 [mm/giro]	Serie Q 35,00-47,8 [mm/giro]	
			TiCN [m/min]	TiAlN [m/min]						
P	Acciaio non legato o da fusione p. e. 9SMn28; 9SMnPb28; 10SPb20	fino a 500	115	125	0,15	0,21	0,28	0,35	0,43	
		500-850	90	105	0,13	0,21	0,28	0,35	0,43	
	Acciaio da costruzione p. e. St33; St37-2; St44-2; St52; St60	350-500	85	95	0,13	0,21	0,26	0,3	0,38	
		500-850	68	75	0,11	0,2	0,21	0,26	0,34	
	Acciaio non legato o debolmente legato, acciaio al carbonio o acciaio stampato p. e. C15; C22; 20Mn5; Ck45	bis 450	110	120	0,13	0,2	0,26	0,32	0,4	
		450-750	85	95	0,11	0,17	0,21	0,31	0,38	
		750-900	70	85	0,11	0,17	0,21	0,31	0,38	
		900-1100	60	70	0,09	0,15	0,2	0,26	0,34	
	Acciaio legato p. e. 42CrMo4; 16MnCr5; 36CrNiMo4 14NiCrMo13-4; Ck75; Ck101; 17CrNiMo8; 35CrMo4; 41Cr4; 50MnSi4	bis 600	90	100	0,13	0,17	0,21	0,31	0,36	
		600-800	80	90	0,11	0,17	0,21	0,31	0,36	
		800-950	70	85	0,11	0,15	0,21	0,31	0,36	
		950-110	67	75	0,09	0,13	0,2	0,26	0,31	
1100-1250		60	65	0,07	0,13	0,2	0,26	0,31		
Acciaio fortemente legato p. e. 41CrAlMo7; 36CrNiMo4; 32NiCrMo14-5	600-1000	55	60	0,11	0,15	0,2	0,21	0,3		
	1000-1200	50	55	0,09	0,11	0,2	0,21	0,3		
	1200-1350	44	50	0,07	0,09	0,17	0,2	0,26		
Acciaio da utensili p. e. C75W; 102Cr6; 105WCr6; X153CrMoV12	500-700	60	65	0,09	0,13	0,17	0,21	0,26		
	700-950	45	50	0,09	0,13	0,17	0,21	0,26		
M	Acciaio inossidabile ed acciaio da fusione	austenitico e austenitico/ferritico	450-610	58	65	0,09	0,16	0,19	0,24	0,3
		temprato	610-930	44	50	0,09	0,14	0,16	0,2	0,25
K	Ghisa p. e. GG25; GG40	perlitica, ferritica	500-700	103	123	0,14	0,2	0,26	0,37	0,45
		perlitica, martensitica	700-850	80	95	0,1	0,16	0,19	0,26	0,37
			850-1100	70	84	0,1	0,14	0,16	0,22	0,32
	Ghisa grigia sferoidale p. e. GGG50	ferritica	540	100	120	0,12	0,17	0,2	0,29	0,45
perlitica		850	75	95	0,1	0,14	0,18	0,26	0,37	
Ghisa malleabile p. e. GTS70	ferritica	450	105	125	0,12	0,17	0,2	0,29	0,4	
	perlitica	780	78	97	0,1	0,14	0,18	0,26	0,37	
N	Leghe di Alluminio a truciolo lungo p. e. AlMgSiPb; AlCuMg1; AlMgSi1	non temprabile	200	410	450	0,1	0,17	0,27	0,33	0,38
		temprabile, temprato	335	275	305	0,12	0,29	0,37	0,52	0,6
	Leghe di Alluminio da getti p. e. G-AlSi10Mg; G-ALSi12	≤ 12% Si, temprato	250	400	450	0,2	0,31	0,4	0,48	0,5
		≤ 12% Si, temprabile, temprato	300	350	380	0,2	0,3	0,4	0,48	0,5
		≤ 12% Si, non temprabile	450	250	280	0,18	0,28	0,36	0,46	0,48
	Rame e leghe di rame (ottone / bronzo)	Legate al piombo, Pb > 1%	370	130	145	0,15	0,23	0,28	0,38	0,45
Ottone / Bronzo		300	160	185	0,16	0,24	0,29	0,39	0,45	
Bronzo alluminio		500	100	110	0,14	0,2	0,26	0,37	0,42	
Rame e rame elettrolitico		200	100	120	0,05	0,09	0,1	0,16	0,25	
Materiali non ferrosi	Plastiche dure	I parametri di taglio dipendono dalla quantità di refrigerante disponibile. Come parametri di partenza utilizzare dati per leghe di alluminio a truciolo lungo.								
	Plastiche rinforzate									
	Gomme dure									
S	Leghe esotiche resistenti alle alte temperature p. e. Inconell, Hasteloy, Nimonic, Waspaloy, Monel	Fe-legate ricotto	700	29	32	0,08	0,16	0,2	0,24	0,3
		temprato	980	-	-	-	-	-	-	-
		Ni o ricotto	850	29	32	0,08	0,16	0,2	0,24	0,3
		Co legato stampato	1100	-	-	-	-	-	-	-
		temprato	1230	21	25	0,08	0,12	0,16	0,18	0,25
	Leghe di titanio, Titanio p. e. Ti99,5; Ti Al6V4; TiCu2	Titanio puro	500-700	33	39	0,09	0,16	0,19	0,24	0,3
H	Acciaio temprato	temprato	1020-1365	40	44	0,09	0,14	0,22	0,25	0,32
		temprato	1365-1850	24	26	0,06	0,11	0,16	0,22	0,27
	Ghisa temprata	stampato	1365	30	35	0,07	0,12	0,18	0,22	0,27
	Ghisa temprata	temprato	2090	-	-	-	-	-	-	-

I parametri di taglio indicati sono da considerarsi come valori massimi ed in ottimali condizioni di lavoro (stabilità sistema, qualità e pressione refrigerante, buona truciolabilità del materiale). Combinare a questi parametri di taglio gli accorgimenti relativi al refrigerante riportati a pagina 107. Per ulteriore supporto tecnico contattare i tecnici ARNO.



Inserti a fondo piano

ISO	Materiale	Carico di rottura [N/mm ²]	Velocità di taglio V _c		Serie A, C 9,5-12,53 [mm/giro]	Serie E, G 12,98-17,53 [mm/giro]	Serie I, K 17,53-24,38 [mm/giro]	Serie M, O 24,41-35,00 [mm/giro]	Serie Q 35,00-47,8 [mm/giro]
			TiCN [m/min]	TiAlN [m/min]					
P	Acciaio non legato o da fusione p. e. 9SMn28; 9SMnPb28; 10SPb20	fino a 500	-	69	0,14	0,2	0,26	0,33	0,41
		500 - 850	-	58	0,12	0,2	0,26	0,33	0,41
	Acciaio da costruzione p. e. St33; St37-2; St44-2; St52; St60	350 - 500	-	48	0,12	0,2	0,24	0,28	0,36
		500 - 850	-	41	0,1	0,18	0,2	0,24	0,32
	Acciaio non legato o debolmente legato, acciaio al carbonio o acciaio stampato p. e. C15; C22; 20Mn5; Ck45	850 - 1200	-	34	0,08	0,16	0,18	0,2	0,28
		bis 450	-	59	0,12	0,18	0,24	0,3	0,38
		450 - 750	-	56	0,1	0,16	0,2	0,29	0,36
		750 - 900	-	52	0,1	0,16	0,2	0,29	0,36
	Acciaio legato p. e. 42CrMo4; 16MnCr5; 36CrNiMo4 14NiCrMo13-4; Ck75; Ck101; 17CrNiMo8, 35CrMo4; 41Cr4; 50MnSi4	900 - 1100	-	48	0,08	0,14	0,18	0,24	0,32
		bis 600	-	52	0,12	0,16	0,2	0,29	0,34
		600 - 800	-	48	0,1	0,16	0,2	0,29	0,34
		800 - 950	-	44	0,1	0,14	0,2	0,29	0,34
		950 - 110	-	41	0,08	0,12	0,18	0,24	0,3
	Acciaio fortemente legato p. e. 41CrAlMo7; 36CrNiMo4; 32NiCrMo14-5	1100 - 1250	-	38	0,06	0,12	0,18	0,24	0,3
600 - 1000		-	28	0,1	0,14	0,18	0,2	0,28	
1000 - 1200		-	22	0,08	0,1	0,18	0,2	0,28	
Acciaio da utensili p. e. C75W; 102Cr6; 105WCr6; X153CrMoV12	1200 - 1350	-	18	0,06	0,09	0,16	0,18	0,24	
	500 - 700	-	28	0,08	0,12	0,16	0,2	0,24	
M	Acciaio inossidabile ed acciaio da fusione	austenitico e austenitico/ferritico	450 - 610	-	26	0,14	0,19	0,2	0,25
		temprato	610 - 930	-	23	0,1	0,15	0,19	0,22
K	Ghisa p. e. GG25; GG40	perlitica, ferritica	500 - 700	-	60	0,14	0,24	0,3	0,42
		perlitica, martensitica	700 - 850	-	47	0,1	0,15	0,2	0,25
			850 - 1100	-	38	0,1	0,12	0,15	0,2
K	Ghisa grigia sferoidale p. e. GGG50	ferritica	540	-	58	0,14	0,24	0,29	0,4
		perlitica	850	-	47	0,1	0,16	0,19	0,24
K	Ghisa malleabile p. e. GTS70	ferritica	450	-	66	0,14	0,24	0,29	0,4
		perlitica	780	-	47	0,1	0,16	0,19	0,24
N	Leghe di Alluminio a truciolo lungo p. e. AlMgSiPb; AlCuMg1; AlMgSi1	non temprabile	200	-	230	0,18	0,29	0,37	0,44
		temprabile, temprato	335	-	120	0,19	0,29	0,37	0,42
	Leghe di Alluminio da getti p. e. G-AlSi10Mg; G-ALSi12	≤ 12 % Si, temprato	250	-	210	0,17	0,29	0,37	0,44
		≤ 12 % Si, temprabile, temprato	300	-	160	0,17	0,29	0,37	0,43
N	Rame e leghe di rame (ottone / bronzo)	≤ 12 % Si, non temprabile	450	-	120	0,17	0,29	0,37	0,42
		Legate al piombo, Pb > 1 %	370	-	70	0,16	0,26	0,38	0,45
		Ottone / Bronzo	300	-	68	0,15	0,25	0,37	0,44
		Bronzo alluminio	500	-	60	0,14	0,24	0,3	0,42
N	Materiali non ferrosi	Rame e rame elettrolitico	200	-	45	0,06	0,09	0,16	0,2
		Plastiche dure	I parametri di taglio dipendono dalla quantità di refrigerante disponibile. Come parametri di partenza utilizzare dati per leghe di alluminio a truciolo lungo.						
		Plastiche rinforzate							
Gomme dure									
S	Leghe esotiche resistenti alle alte temperature p. e. Inconell, Hasteloy, Nimonic, Waspaloy, Monel	Fe-legate ricotto	700	-	10	0,08	0,14	0,17	0,22
		temprato	980	-	-	-	-	-	-
		Ni o ricotto	850	-	9	0,08	0,13	0,15	0,19
		Co legato stampato	1100	-	-	-	-	-	-
		temprato	1230	-	8	0,07	0,12	0,14	0,17
S	Leghe di titanio, Titanio p. e. Ti99,5; Ti Al6V4; TiCu2	Titanio puro	500 - 700	-	15	0,09	0,15	0,19	0,24
			700 - 1050	-	12	0,09	0,14	0,15	0,19
H	Acciaio temprato	temprato	1020 - 1365	-	20	0,09	0,14	0,19	0,24
		temprato	1365 - 1850	-	13	0,09	0,1	0,15	0,19
	Ghisa temprata	stampato	1365	-	18	0,09	0,12	0,16	0,19
H	Ghisa temprata	temprato	2090	-	-	-	-	-	

I parametri di taglio indicati sono da considerarsi come valori massimi ed in ottimali condizioni di lavoro (stabilità sistema, qualità e pressione refrigerante, buona truciolabilità del materiale). Combinare a questi parametri di taglio gli accorgimenti relativi al refrigerante riportati a pagina 107. Per ulteriore supporto tecnico contattare i tecnici ARNO.

ISO	Materiale	Refrigerante Pressione [bar] Portata [litre/min]	Inserto acciaio super rapido (HSS)							Inserto metallo duro				
			Serie A, C 9,5-12,95	Serie E, G 12,98-17,53	Serie I, K 17,53-24,38	Serie M, O 24,41-35,00	Serie Q 35,00-47,80	Serie S 47,85-65,00	Serie U, W 66,00-114,48	Serie A, C 9,5-12,95	Serie E, G 12,98-17,53	Serie I, K 17,53-24,38	Serie M, O 24,41-35,00	Serie Q 35,00-47,80
P	Acciaio non legato o da fusione	[bar] [litre/min]	12 10	6 10	7 16	6 27	5 45	3 114	3 144	12 10	7 11	7 17	7 30	7 60
	Acciaio da costruzione	[bar] [litre/min]	11 9	6 10	6 16	5 23	5 45	3 114	3 144	12 10	7 11	6 16	6 27	5 47
	Acciaio non legato o debolmente legato, acciaio al carbonio o acciaio stampato	[bar] [litre/min]	11 9	4 11	4 12	2 19	2 30	2 87	2 98	11 9	4 10	4 12	4 19	3 40
	Acciaio legato	[bar] [litre/min]	12 9	6 10	5 14	4 23	4 38	2 98	2 117	15 11	10 13	10 22	9 34	7,5 56
	Acciaio fortemente legato	[bar] [litre/min]	11 9	5 8	4 12	2 20	2 30	2 87	2 98	15 11	5 12	4 13	4 20	3 40
	Acciaio da utensili	[bar] [litre/min]	11 10	4 8	4 12	3 20	2 30	2 87	2 98	15 11	5 12	4 13	3 20	3 37
M	Acciaio inossidabile ed acciaio da fusione	[bar] [litre/min]	12 10	6 10	5 14	4 23	4 38	2 98	2 117	15 11	10 13	10 22	9 34	9 70
K	Ghisa	[bar] [litre/min]	11 9	5 9	4 13	3 19	2 34	2 98	2 106	11 9	5 9	5 12	5 19	4 49
	Ghisa grigia sferoidale	[bar] [litre/min]	11 9	5 9	4 13	3 19	2 34	2 98	2 106	11 9	5 9	5 12	5 19	4 49
	Ghisa malleabile	[bar] [litre/min]	11 9	5 9	4 13	3 19	2 34	2 98	2 106	11 9	5 9	5 13	5 19	4 49
N	Leghe di Alluminio a truciolo lungo	[bar] [litre/min]	15 10	12 14	16 23	11 34	9 61	4 125	4 159	22 13	19 17	19 28	17 45	14 77
	Leghe di Alluminio da getti	[bar] [litre/min]	15 10	12 14	16 23	11 34	9 61	4 125	4 159	22 13	19 17	19 28	17 45	14 77
	Rame e leghe di rame (ottone / bronzo)	[bar] [litre/min]	13 10	8 11	10 20	8 30	7 53	4 125	4 167	14 10	10 13	10 21	10 34	10 75
	Materiali non ferrosi	[bar] [litre/min]	Utilizzo di aria raccomandato.											
S	Leghe esotiche resistenti alle alte temperature	[bar] [litre/min]	11 9	4 11	4 12	2 19	2 30	2 87	2 98	18 10	11 11	10 12	10 19	9 62
	Leghe di titanio, Titanio	[bar] [litre/min]	11 9	5 9	4 12	2 19	2 30	2 98	2 125	18 10	11 11	10 16	10 27	9 62
H	Acciaio temprato	[bar] [litre/min]	11 9	4 11	4 12	2 19	2 30	2 87	2 98	11 9	4 10	4 12	3 19	3 37
	Ghisa temprata	[bar] [litre/min]	11 9	4 11	4 12	2 19	2 30	2 87	2 98	11 9	4 10	4 12	3 19	3 37
	Ghisa temprata	[bar] [litre/min]	- -	- -	- -	- -	- -	- -	- -	- -	- -	- -	- -	- -

Questi suggerimenti consentono un'ottima durata utensile e evacuazione truciolo. Con valori più bassi si deve prestare attenzione all'usura e all'evacuazione truciolo. Se necessario le velocità e gli avanzamenti dovranno essere ridotti.

Informazione: Prego notare che i valori di portata del refrigerante sono riferiti ad una profondità di foratura 8xD.

Per fori più profondi moltiplicare i valori raccomandati come segue: da 8 a 12xD moltiplicare per 1.3 da 12 a 20xD moltiplicare per 2.0 oltre 20xD moltiplicare per 3.

Anbohren oder Zentrieren / Sport drill / Foro di centraggio

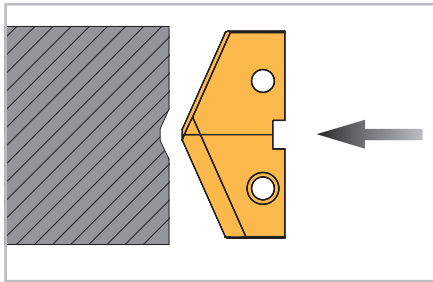

Die Bohrplatte unseres „SHARK-Drill®“-Bohrers sind stark ausgespitzt, sodass ein Anzentrieren erst ab 8xD Bohrtiefe erforderlich ist.

Achtung: Spitzen ✂ **der Bohrplatten:**
bis Ø 65 mm = 132°
bis Ø 114 mm = 144°
Der Zentrierbohrer muss einen gleichen oder größeren Spitzenwinkel haben.

The inserts for our “SHARK-Drill®” got a self-centering point. To spot the hole is only required when you drill deeper than 8xD.

Attention: Point ✂ inserts:
up to Ø 65 mm = 132°
up to Ø 114 mm = 144°
The spot drill must have the same or a bigger spot.

Gli inserti del sistema “SHARK-Drill®” possono eseguire anche il foro da centro. Eseguire un foro da centro è suggerito per fori con profondità superiore a 8xD o in condizioni di centraggio difficili.

Attenzione: Inserti con cuspidi:
fino a Ø 65 mm = 132°
fino a Ø 114 mm = 144°
Il foro da centro deve avere identico o maggiore angolo di cuspidi.

Verlaufen des Bohrers / Holder deflection / Deviazione del foro

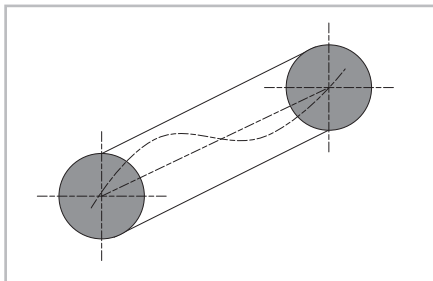

Das „Verlaufen“ des Bohrers ist von mehreren Faktoren abhängig:

- Werkstückspannung
- Werkzeugspannung
- Homogenität des Materials
- Durchmesser/Bohrtiefenverhältnis

The run out of the drill is depending on several issues:

- Component clamping
- Tool clamping
- Material
- Diameter / depth ratio

La deviazione dell'utensile dipende da diversi fattori:

- Staffaggio del pezzo
- Serraggio dell'utensile
- Materiale
- Rapporto Diametro / Profondità

Spanbruch bei zähen Materialien / Chipping in tough materials / Evacuazione in materiali difficili



Viele Stähle mit hohen Cr- und Ni- Anteilen können allein durch die Spanbrecher und Spanformer nicht gebrochen werden. Es hilft einzig (aber zuverlässig) ein Spanzyklus:

- Rückzugweg 0,1 mm bleibt immer gleich!
- Bohrerweg so anpassen, dass Späne problemlos ausgespült werden!

Many steels with high Cr and Ni content can only be drilled with a peck cycle:

- 0.1 mm back is always the same
- Drill depth in the peck cycle should not be too long (coolant must float out the chips)

Molti materiali con elevato contenuto di Cr e Ni, possono venire forati solamente con cicli di scarico truciolo:

- 0,1 mm di ritorno è il valore suggerito
- La profondità di ogni foratura del ciclo non deve mai essere troppo lunga (il refrigerante deve far evacuare il truciolo)

Niedriger Kühlmitteldruck / Low coolant pressure / Bassa pressione del refrigerante

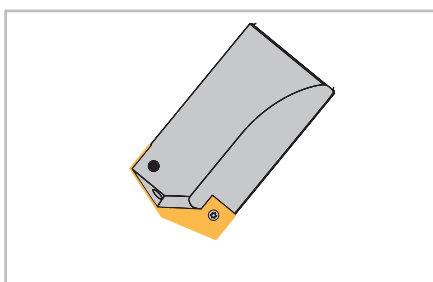

Bei niedrigem Kühlmitteldruck müssen die Schnittwerte nach unten korrigiert werden. Das Kühlmittel ist bei diesem Werkzeug für die Spanausbringung sehr wichtig. Ohne innere Kühlmittelzufuhr ist die Funktion nur bis 1,5xD Bohrtiefe gewährleistet.

Achtung: Je mehr Kühlmitteldruck und -menge umso besser!

With low coolant supply, speeds and feeds must be reduced. Internal coolant supply is necessary over 1.5xD drill depth.

Attention: High coolant pressure and volume give you better results.

Con basse pressioni del refrigerante, velocità ed avanzamenti vanno ridotti. Per forature superiori a 1,5xD è indispensabile l'adduzione interna del refrigerante.

Attenzione: Pressione e portata elevate del refrigerante offrono sempre risultati migliori.

Unterbrochener Schnitt oder schräges Anbohren / Interrupted cutting / Taglio interrotto

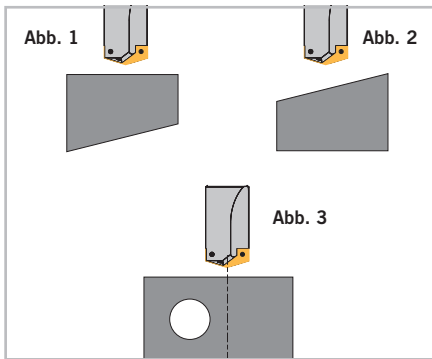

Unterbrochener Schnitt oder schräges Anbohren wird nicht empfohlen, da die Abstützung der Bohrerplatte nur relativ gering ist!

Abb. 1+2: Unter Reduzierung der Schnittwerte bis $\sphericalangle 7^\circ$ teils möglich.
Abb. 3: Fast unmöglich! Besprechen Sie mit uns Ihren Anwendungsfall, wir versuchen eine Lösung zu finden!

Interrupted cutting is not recommended. Due lead of you may get damaged holders, excessive lead wear, oversize holes.

*Pic. 1+2: By reduction speed, it may possible up to $\sphericalangle 7^\circ$.
Pic. 3: Nearly impossible. Please call our Application Helpline. We try to find a solution.*

Il taglio interrotto non è consigliato. Questo perché si possono danneggiare i portautensili, usurare precocemente gli inserti ed i fori possono risultare maggiorati.

Fig. 1+2: Riducendo la velocità, possibile fino a $\sphericalangle 7^\circ$. Fig. 3: Non possibile. Chiamare il supporto tecnico per una soluzione.



Ausbrüche an der Bohrerplatte / Fracture of inserts / Rotture di inserti

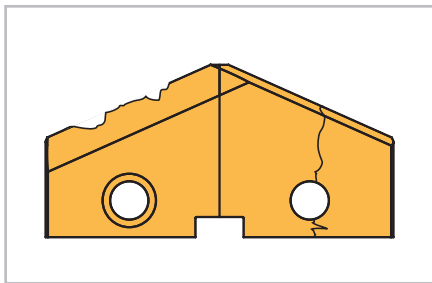

Bricht die Bohrerplatte aus oder zerbricht völlig, so ist die gewählte Qualität zu hart für die Anwendung. Stellen Sie auf eine zähere Qualität um (z.B. von Hartmetall auf HSS) oder ändern Sie etwas an den Rahmenbedingungen (wenn möglich unterbrochenen Schnitt vermeiden). Hartmetall nur unter stabilen Rahmenbedingungen einsetzen.

When the insert fracture, the Quality (Grade) is too brittle for the Application. Please use a tougher grade (for example: from Carbide to HSS) or change the cutting environment. Use Carbide only when workholding is stable and the drill depth is $< 5 \times D$. Also a high quality machine is necessary.

Quando l'inserto si frattura significa che la qualità che si sta utilizzando (grado) è troppo fragile per l'applicazione che si sta eseguendo. Utilizzare un grado più tenace (per esempio sostituire la cuspide in metallo duro con una in HSS) o modificare le condizioni di taglio. Utilizzare le cuspidi di foratura in metallo duro solamente quando il sistema di staffaggio è stabile e la profondità di foratura è $< 5 \times D$. E' anche necessario lavorare con una macchina utensile di qualità elevata.

Ausbrennen der Platte (HSS) / Accelerated insert wear / Precoce usura degli inserti

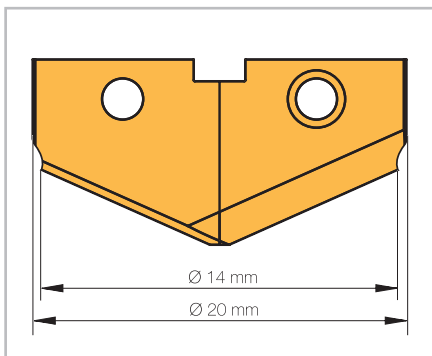

Bsp.: Bohren in C45 mit P120 HSS5 / TiAlN: $n = 850 \text{ U/min}$ $f = 0,25 \text{ mm}$
E.g.: C45 with P120 HSS5 / TiAlN: $rev = 850 \text{ 1/min}$ $f = 0.25 \text{ mm/rev}$
Es.: C45 con P120 HSS5 / TiAlN: $n = 850 \text{ U/min}$ $f = 0,25 \text{ mm/giro}$

$$V_c = \frac{n \times \pi \times D}{1000} = \frac{850 \times \pi \times 14}{1000} = 37 \text{ m/min}$$

somit für Ø 20 mm
for dia. 20 mm
per Ø 20 mm

$$n = \frac{37 \times 1000}{\pi \times D} = 588 \text{ U/min}$$

d.h.: Eine Drehzahl von 588 U/min wäre für Ø 20 mm unter den gegebenen Bedingungen (Kühlmittel, Material, Aufspannung) die „richtige“ Drehzahl.

i.e.: 588 rev/min would have been the right speed in this application.
p.e.: 588 g/min è la velocità corretta a cui deve girare la punta per questa applicazione.

Wenn die Platte in dieser Art und Weise verschlissen ist, war entweder der Kühlmittel- druck zu gering oder der Werkstoff wurde falsch eingeschätzt. Sofern möglich, verwenden Sie eine härtere Sorte. Da an der Bohrer- spitze kein Verschleiß zu sehen ist, war der Vorschub korrekt aber die Drehzahl bei den gegebenen Rahmenbedingungen zu hoch.

Anhand des Ø 14 mm im Beispiel, der bei der angewandten Drehzahl noch „stehen“ bleibt, kann man für den Ø 20 mm die richtige Dreh- zahl zurückrechnen.

On the drill insert is no wear, that shows the feedrate was ok, the revolutions are too high in this cutting environment.

With the dia. 14 mm in the example, the rest dia, you can calculate back, what would have been the correct speed for the original dia. 20 mm.

Se sugli inserti sono presenti segni di usura significa che si sta lavorando con una velocità di avanza-mento adatta ma con velocità di taglio troppo elevata per queste condizioni di lavoro.

Dall' esempio si può capire che al momento si sta lavorando con una velocità di taglio appropriata per un dia. 14 mm e non per un dia. 20 mm.

EINSATZHINWEISE FÜR ...

... (extra-) kurze bis Standard-Halter beim Bohrsystem SHARK-Drill®

Um eine einwandfreie Funktion der Bohrer zu gewährleisten, hat sich folgende Vorgehensweise bewährt:

- 1) Erforderlichen Kühlmitteldruck sowie das benötigte Durchflussvolumen prüfen und ggf. anpassen (siehe Seite 99).
- 2) Bereits bei der ersten Bohrung Spanbruch- und Schnittwertoptimierung durchführen. Ziel sind kurze und leicht ausspülbare Späne.
- 3) Messen der Bohrung und überprüfen, ob die empfohlene Toleranz eingehalten wird.
- 4) Während der Bearbeitung ständig sicherstellen, dass die Späne kurz sind und locker ausgespült werden. Gegebenenfalls ist ein Bohrzyklus erforderlich.

Immer den kürzest möglichen Bohrer wählen!

Achtung: Hartmetallplatten sind normalerweise bis ca. **6 bis 7 x D** Tiefe einsetzbar!

Spanentwicklung – Folgende Vorgehensweise hat sich als vorteilhaft erwiesen:

- Spanentwicklung beobachten.
- Falls der max. Vorschub noch nicht erreicht ist, bringt eine Vorschuberrhöhung oftmals einen besseren Spanbruch.
- Sollte keine dieser Maßnahmen zum Erfolg führen, bietet sich ein Spanbruchzyklus an.

Viele Materialien aus dem Bereich der rostfreien Stähle, aber zum Teil auch andere Materialien, lassen sich nicht allein über „ V_c “ und „ f “ zum brechen bringen. In solchen Fällen ist der Einsatz eines Spanbruchzyklus erforderlich.

Dieser sollte nur eine kleine Spanunterbrechung beinhalten (mit ca. 0,1 mm Abhebemaß). Ein Tieflochbohrzyklus mit Rückzugsebene außerhalb des Werkstücks ist nicht empfehlenswert. Als inkrementelles Zustellmaß (erster Richtwert) kann ca. 10% des Bohrdurchmessers empfohlen werden (z. B. 20 mm Bohrdurchmesser = Zustellmaß 2 mm).

EINSATZHINWEISE FÜR ...

... überlange Halter beim Bohrsystem SHARK-Drill®

Um eine einwandfreie Funktion der Bohrer zu gewährleisten, hat sich folgende Vorgehensweise bewährt:

- 1) Pilotbohrung (ca. 1 x D) im gleichen Durchmesser setzen. Spitzenwinkel größer/gleich SHARK-Drill® Bohrer. Weitere Startmöglichkeiten sind:
 - Anzentrieren mit 132° Spitzenwinkel (bis Ø 65 mm).
 - Anzentrieren mit 144° Spitzenwinkel (bis Ø 65-114 mm).
 - Behutsames Anbohren (mit ca. 50% des empfohlenen Vorschubs) bis zum Erreichen des vollen Durchmessers.

- 2) Spanbruch- und Schnittwertoptimierung bereits vor dem Einsatz (möglichst mit der Pilotbohrung) durchführen. Ziel sind kurze und leicht ausspülbare Späne. Schnittwerte wie folgt anpassen:

	8 – 11 x D	12 – 14 x D
V_c [m/min]	0,9	0,58
f [mm/U]	x	0,9

- 3) Die Kühlmittlempfehlungen (siehe Seite 99) sind mit folgenden Multiplikatoren zu verwenden: SHARK-Drill® (8 – 11 x D) x 1,3 / (12 – 14 x D) x 1,5.
- 4) Messen der Bohrung und überprüfen, ob die Toleranz eingehalten wird.
- 5) Schnittwerte auf die zuvor getesteten Werte steigern und fertig bohren. Dabei sicherstellen, dass die Späne kurz sind und ständig locker ausgespült werden. Gegebenenfalls ist ein Bohrzyklus erforderlich.

Immer den kürzest möglichen Bohrer wählen!

Achtung: Der Einsatz von Hartmetallplatten ist hier unter Umständen nicht empfehlenswert!

Spanentwicklung – Folgende Vorgehensweise hat sich als vorteilhaft erwiesen:

- Spanentwicklung beobachten.
- Falls der max. Vorschub noch nicht erreicht ist, bringt eine Vorschuberrhöhung oftmals einen besseren Spanbruch.
- Sollte keine dieser Maßnahmen zum Erfolg führen, bietet sich ein Spanbruchzyklus an.

Viele Materialien aus dem Bereich der rostfreien Stähle, aber zum Teil auch andere Materialien, lassen sich nicht allein über „ V_c “ und „ f “ zum brechen bringen. In solchen Fällen ist der Einsatz eines Spanbruchzyklus erforderlich.

Dieser sollte nur eine kleine Spanunterbrechung beinhalten (mit ca. 0,1 mm Abhebemaß). Ein Tieflochbohrzyklus mit Rückzugsebene außerhalb des Werkstücks ist nicht empfehlenswert. Als inkrementelles Zustellmaß (erster Richtwert) kann ca. 10% des Bohrdurchmessers empfohlen werden (z. B. 20 mm Bohrdurchmesser = Zustellmaß 2 mm).

EINSATZHINWEISE FÜR ...

... extrem lange Halter beim Bohrsystem SHARK-Drill®

Um eine einwandfreie Funktion der Bohrer zu gewährleisten, hat sich folgende Vorgehensweise bewährt:

- 1) Pilotbohrung (ca. 1 bis 2xD) im gleichen Durchmesser setzen. Spitzenwinkel größer/gleich SHARK-Drill® Bohrer.

Weitere Startmöglichkeiten sind:

- Anzentrieren mit 132° Spitzenwinkel (bis Ø 65 mm) – behutsames Anbohren (mit ca. 50% des empfohlenen Vorschubes) bis zum Erreichen des vollen Durchmessers.
- Anzentrieren mit 144° Spitzenwinkel (bei Ø 65 – 114 mm) – behutsames Anbohren (mit ca. 50% des empfohlenen Vorschubes) bis zum Erreichen des vollen Durchmessers.

- 2) Spanbruch und Schnittwertoptimierung bereits vor dem Einsatz des langen Bohrers. Dafür wird am besten der Pilotbohrer verwendet. Ziel sind kurze, leichte Späne, die einfach ausgespült werden können.

- 3) Erforderlichen Kühlmitteldruck und Durchflussmenge prüfen. Die Kühlmittlempfehlungen (siehe Seite 99) sind mit folgenden Multiplikatoren zu verwenden:

SHARK-Drill® (20 – 24 x D) x 2,0 / (25 – 32 x D) x 3,0.

- 4) Schnittwerte wie folgt anpassen:

	20 – 24 x D	25 – 32 x D
V_c [m/min]	0,80	0,75
f [mm/U]	0,80	0,80

- 5) Mit dem langen Bohrer stehend oder mit 10 – 20 U/min in die Bohrung einfahren.

- 6) Schnittwerte auf die vorher getesteten Werte hochfahren und fertig bohren. Dabei sicherstellen, dass die Späne kurz sind und ständig locker ausgespült werden. Gegebenenfalls ist ein (weiterer) Bohrzyklus erforderlich.

- 7) Nach dem Erreichen der Endbohrtiefe, die Spindel stoppen oder mit 10 – 20 U/min aus der Bohrung herausfahren.

- 8) Bitte beachten Sie ein mögliches Verlaufen des Bohrers dieser Länge.

Spanentwicklung

– Folgende Vorgehensweise hat sich als vorteilhaft erwiesen:

Bis zu einer Bohrtiefe von 1 bis 2 x D die Spanentwicklung beobachten. Bei zu langen Spänen die Schnittwerte anpassen.

Viele Materialien aus dem Bereich der rostfreien Stähle, aber zum Teil auch andere Materialien, lassen sich nicht allein über „ V_c “ und „ f “ zum Brechen bringen. In solchen Fällen ist der Einsatz eines Spanbruchzyklus erforderlich.

Dieser sollte nur eine kleine Spanunterbrechung beinhalten (mit ca. 0,1 mm Abhebemaß). Ein Tieflochbohrzyklus mit Rückzugsebene außerhalb des Werkstücks ist nicht empfehlenswert. Als inkrementelles Zustellmaß (erster Richtwert) kann ca. 10% des Bohrdurchmessers empfohlen werden (z. B. 20 mm Bohrdurchmesser = Zustellmaß 2 mm).

Tipp:

Falls die Vorschubwerte vorher nicht schon grenzwertig waren, bringt eine Vorschüberhöhung oftmals einen besseren Spanbruch. Sollte dies nicht zum Erfolg führen, bietet sich ein Spanbruchzyklus an.

RECOMMENDATIONS FOR ...

... SHARK-Drill® (extra) short to standard holder

In order to obtain a problem free machining with the drills, the following has proven successful:

- 1) Check and possibly adjust coolant pressure (see page 103).
- 2) Immediately after the first cut we suggest a chip breaking and cutting data review. The target should be short and easily removable swarf.
- 3) Measure the hole and check that tolerance is acceptable.
- 4) During the machining always ensure that the swarf is short and removed from the hole. Otherwise a pecking cycle may be required.

Always select shortest possible drill!

Important: Carbide inserts only suitable up to approx. $6 - 7 \times D$.

Swarf control – The following recommendations have also proved advantageous:

- Monitor swarf control.
- If not yet at maximum feed rate potential, an increase in feed rate can lead to better chip breaking.
- If none of these changes are successful it may be necessary to insert a pecking cycle.

For many materials in the stainless steel area, but also others, it may not always be possible to achieve acceptable chip breaking simply by adjusting V_c and f . In such cases a pecking cycle will be needed. This should only be a small peck cycle of approx 0.1 mm.

A pecking cycle where the tool is removed out of the hole is not recommended. As a rule take increments of approx 10% of the drill diameter (e.g. 20 mm diameter = 2 mm peck depth).

RECOMMENDATIONS FOR ...

... the extended SHARK-Drill®

In order to obtain a problem free machining with the drills, the following has proven successful:

- 1) Pilot drilling (approx. $1 \times D$) with same diameter. The drill point should be same or larger than SHARK-Drill® insert. Other start options:
 - Centering with 132 degree drill point (up to 65 mm).
 - Centering with 144 degree drill point (from 64 – 114 mm).
 - Careful penetration (approx 50% of recommended feed rate) until full diameter is achieved.

- 2) Chip breaking and cutting data optimizing before starting. Target is short and easy to evacuate swarf. Modify cutting data as below:

	8 – 11 x D	12 – 14 x D
V_c [m/min]	0.9	0.58
f [mm/U]	x	0.9

- 3) Check the coolant pressure and flow rate. The coolant pressure (see page 103) can be adjusted using the following formula: SHARK-Drill® ($8 - 11 \times D$) $\times 1.3 / (12 - 14 \times D) \times 1.5$.
- 4) Measure the hole and check that tolerance is acceptable.
- 5) Increase cutting data to previously established data and finish drilling, making sure that the swarf remains short and leaving the hole problem free. Otherwise a peck cycle may be required.

Always select shortest possible drill!

Attention: Carbide inserts are not recommended.

Swarf control – The following recommendations have also proved advantageous:

- Monitor swarf control.
- If not yet at maximum feed rate potential, an increase in feed rate can lead to better chip breaking.
- If none of these changes are successful it may be necessary to insert a pecking cycle.

For many materials in the stainless steel area, but also others, it may not always be possible to achieve acceptable chip breaking simply by adjusting V_c and f . In such cases a pecking cycle will be needed. This should only be a small peck cycle of approx 0.1 mm.

A pecking cycle where the tool is removed out of the hole is not recommended. As a rule take increments of approx 10% of the drill diameter (e.g. 20 mm diameter = 2 mm peck depth).

RECOMMENDATIONS FOR ...

... the extreme long SHARK-Drill®

In order to obtain a problem free machining with the drills, the following has proven successful:

- 1) Pilot drilling (approx. $1 \times D$) with same diameter. The drill point should be same or larger than SHARK-Drill® insert.
Other start options:
 - Centering with 132 degree drill point (up to 65 mm) – careful penetration (approx. 50% of recommended feed rate) until full diameter is achieved.
 - Centering with 144 degree drill point (from 64 – 114 mm) – careful penetration (approx. 50% of recommended feed rate) until full diameter is achieved.
- 2) Swarf control and cutting data optimizing should be performed before full depth drilling, we suggest using the pilot drill. The target short and easily evacuated swarf.
- 3) Check the coolant pressure and flow rate. The coolant pressure (see page 103) can be adjusted using the following formula: SHARK-Drill® $(20 - 24 \times D) \times 2.0 / (25 - 32 \times D) \times 3.0$.

- 4) The cutting data should also be modified depending on drill depth:

	20 – 24 x D	25 – 32 x D
V_c [m/min]	0.80	0.75
f [mm/U]	0.80	0.80

- 5) With the long drill stationary or penetration with 10 – 20 rev./min.
- 6) Increase cutting data to previously established data and finish drilling, making sure that the swarf remains short and leaving the hole problem free. Otherwise a peck cycle may be required.
- 7) When reaching the depth required stop the spindle or reduce to 10 – 20 rev./min and feed out the drill.
- 8) Note that the extra long and extreme long drills do deflect.

Swarf control – The following recommendations have also proved advantageous:

Up to drill depth of $1 - 2 \times D$ monitor swarf. If the swarf is too long, cutting data should be modified.

For many materials in the stainless steel area, but also others, it may not always be possible to achieve acceptable chip breaking simply by adjusting V_c and f . In such cases a pecking cycle will be needed. This should only be a small peck cycle of approx 0.1 mm.

A pecking cycle where the tool is removed out of the hole is not recommended. As a rule take increments of approx 10% of the drill diameter (e.g. 20 mm diameter = 2 mm peck depth).

Tipp:

If not yet at maximum feed rate potential, an increase in feed rate can lead to better chip breaking. If none of these changes are successful it may be necessary to insert a pecking cycle.

SUGGERIMENTI PER ...

... corte e lunghezze standard SHARK-Drill®

Per una foratura senza problemi con punte seguire i seguenti accorgimenti:

- 1) Verificare e se possibile regolare la pressione del refrigerante (pag. 107).
- 2) Immediatamente dopo i primi millimetri di foro adattare i parametri di taglio. L'obiettivo è di ottenere un truciolo corto facilmente evacuabile dal foro.
- 3) Misurare il primo foro ed i fori seguenti per assicurarsi se la precisione è accettabile.
- 4) Durante la lavorazione assicurarsi sempre che il truciolo sia corto e che esca costantemente dal foro assieme al refrigerante. Nel caso di truciolo lungo prevedere un ciclo con stacchi per forzare la rottura truciolo.

Scegliere sempre il corpo più corto possibile.

Importante: Inserti in metallo duro integrale utilizzabili solo fino a circa **6 – 7 x D**.

Controllo truciolo

– I seguenti accorgimenti sono inoltre suggeriti:

- Controllare costantemente forma ed evacuazione truciolo.
- Qualora non sia ancora stato raggiunto il limite massimo consigliato, per un miglior controllo truciolo può essere utile aumentare l'avanzamento. Questo aiuta la rottura del truciolo.
- Se nessuno di questi cambiamenti porta ad un controllo truciolo, può essere indispensabile prevedere un ciclo con stacchi.

Per molti materiali, e specialmente per gli acciai della categoria inossidabili, può non essere sufficiente raggiungere il controllo truciolo solo modificando V_c ed f . In questi casi un ciclo con degli stacchi va previsto. Lo stacco non deve mai essere superiore a 0,1 mm. Prevedere un ciclo con la completa fuoriuscita del corpo punta dal foro non è raccomandato. Trucioli potrebbero interpersi tra tagliente e fondo del foro. Come regola generale considerare come partenza profondità di ogni ciclo pari a circa il 10% del diametro di foratura (Pes: 20 mm diametro = 2 mm profondità).

SUGGERIMENTI PER ...

... corpi punta Lunghi (11 x D) ed Extra lunghi (14 x D) SHARK-Drill®

Per una foratura senza problemi con punte seguire i seguenti accorgimenti:

- 1) Punta pilota (circa 1 x D) con il medesimo diametro. L'angolo di punta deve essere uguale o maggiore dell'inserto SHARK-Drill®. Altre soluzioni:
 - Eseguire impronta conica con punte da centro ad angolo 132° (fino a Ø 65).
 - Eseguire impronta conica con punte da centro ad angolo 144° (da Ø 65 fino a Ø 114).
 - Ridurre avanzamenti (circa il 50% del parametro suggerito) fino a che l'intero diametro è in lavoro.

- 2) Aggiustare i parametri nei primi mm di foro per avere un miglior controllo delle condizioni di formazione del truciolo. Modificare i parametri ottimali come segue:

	8 – 11 x D	12 – 14 x D
V_c [m/min]	0,9	0,58
f [mm/U]	x	0,9

- 3) Controllare la pressione e la portata del refrigerante. La pressione del refrigerante (vedi pag. 107) va regolata seguendo la formula: SHARK-Drill® (8 – 11 x D) x 1,3 / (12 – 14 x D) x 1,5.
- 4) Misurare la prima parte del foro ed i primi fori per verificare se la tolleranza del foro è accettabili.
- 5) Aumentare i parametri di taglio fino ai valori prestabiliti e concludere la lavorazione assicurandosi di ottenere una gestione truciolo sicura. Prevedere eventuali cicli di stacco per aiutare la rottura del truciolo (mai oltre 0,1 mm).

Scegliere sempre il corpo più corto possibile.

Attenzione: Cuspidi in metallo duro sconsigliate.

Controllo truciolo

– I seguenti accorgimenti sono inoltre suggeriti:

- Controllare costantemente forma ed evacuazione truciolo.
- Qualora non sia ancora stato raggiunto il limite massimo consigliato, per un miglior controllo truciolo può essere utile aumentare l'avanzamento. Questo aiuta la rottura del truciolo.
- Se nessuno di questi cambiamenti porta ad un controllo truciolo, può essere indispensabile prevedere un ciclo con stacchi.

Per molti materiali, e specialmente per gli acciai della categoria inossidabili, può non essere sufficiente raggiungere il controllo truciolo solo modificando V_c ed f . In questi casi un ciclo con degli stacchi va previsto. Lo stacco non deve mai essere superiore a 0,1 mm. Prevedere un ciclo con la completa fuoriuscita del corpo punta dal foro non è raccomandato. Trucioli potrebbero interpersi tra tagliente e fondo del foro. Come regola generale considerare come partenza profondità di ogni ciclo pari a circa il 10% del diametro di foratura (Pes: 20 mm diametro = 2 mm profondità).

SUGGERIMENTI PER ...

... corpi punta Super Lunghi e Ultra Lunghi SHARK-Drill®

Per una foratura senza problemi con punte seguire i seguenti accorgimenti:

- 1) Foro pilota (approx. $1 \times D - 2 \times D$) con il medesimo diametro. L'angolo di cuspidi del foro pilota deve essere uguale o maggiore di quello dell'inserto SHARK-Drill®. Altre soluzioni:
 - Eseguire impronta conica con punte da centro ad angolo 132° (fino a $\varnothing 65$) – ridurre gli avanzamenti (circa 50% del valore suggerito) fino al raggiungimento dell'intero diametro.
 - Eseguire impronta conica con punte da centro ad angolo 144° (da $\varnothing 65$ fino a $\varnothing 114$) – ridurre gli avanzamenti (circa 50% del valore suggerito) fino a che l'intero diametro è in lavoro.
- 2) Ottenere i parametri ottimali di lavoro nei primi mm di foro. Solo così si potrà controllare visivamente la formazione del truciolo. Utilizzare sempre punte da centro specifiche per l'impronta e produrre trucioli più corti possibili per aiutare l'evacuazione.
- 3) Controllare la pressione e la portata del refrigerante. La pressione del refrigerante (vedi pag. 107) va regolata seguendo la formula: SHARK-Drill® ($20 - 24 \times D$) $\times 2,0 / (25 - 32 \times D) \times 3,0$.

- 4) Modificare i parametri ottimali come segue:

	20 – 24 x D	25 – 32 x D
V_c [m/min]	0,80	0,75
f [mm/U]	0,80	0,80

- 5) Per fori molto profondi prevedere l'uso di più corpi punta al fine di utilizzare parametri di taglio non ridotti dalla precedente formula. In questi casi prima che il corpo punta Super Lungo entri nel foro prevedere una rotazione massima di 10 – 20 giri/min. Le punte Super Lunghe e Ultra Lunghe possono raggiungere i parametri suggeriti solo quando l'inserto è in guida.
- 6) Aumentare i parametri di taglio fino ai valori prestabiliti e concludere la lavorazione assicurandosi di ottenere una gestione truciolo sicura. Prevedere eventuali cicli di stacco per aiutare la rottura del truciolo (mai oltre 0,1 mm).
- 7) Raggiunta la fine del foro arretrare mantenendo una rotazione di 10 – 20 giri/min.
- 8) Notare che i corpi punta di queste lunghezze flettono sollecitati al carico di punta.

Controllo truciolo

– I seguenti accorgimenti sono inoltre suggeriti:

- Controllare costantemente forma ed evacuazione truciolo.
- Qualora non sia ancora stato raggiunto il limite massimo consigliato, per un miglior controllo truciolo può essere utile aumentare l'avanzamento. Questo aiuta la rottura del truciolo.
- Se nessuno di questi cambiamenti porta ad un controllo truciolo, può essere indispensabile prevedere un ciclo con stacchi.

Per molti materiali, e specialmente per gli acciai della categoria inossidabili, può non essere sufficiente raggiungere il controllo truciolo solo modificando V_c ed f . In questi casi un ciclo con degli stacchi va previsto. Lo stacco non deve mai essere superiore a 0,1 mm. Prevedere un ciclo con la completa fuoriuscita del corpo punta dal foro non è raccomandato. Trucioli potrebbero interpersi tra tagliente e fondo del foro. Come regola generale considerare come partenza profondità di ogni ciclo pari a circa il 10% del diametro di foratura (Pes: 20 mm diametro = 2 mm profondità).

Schnittwerte-Multiplikator / Cutting data multiplier / Fattori di riduzione parametri

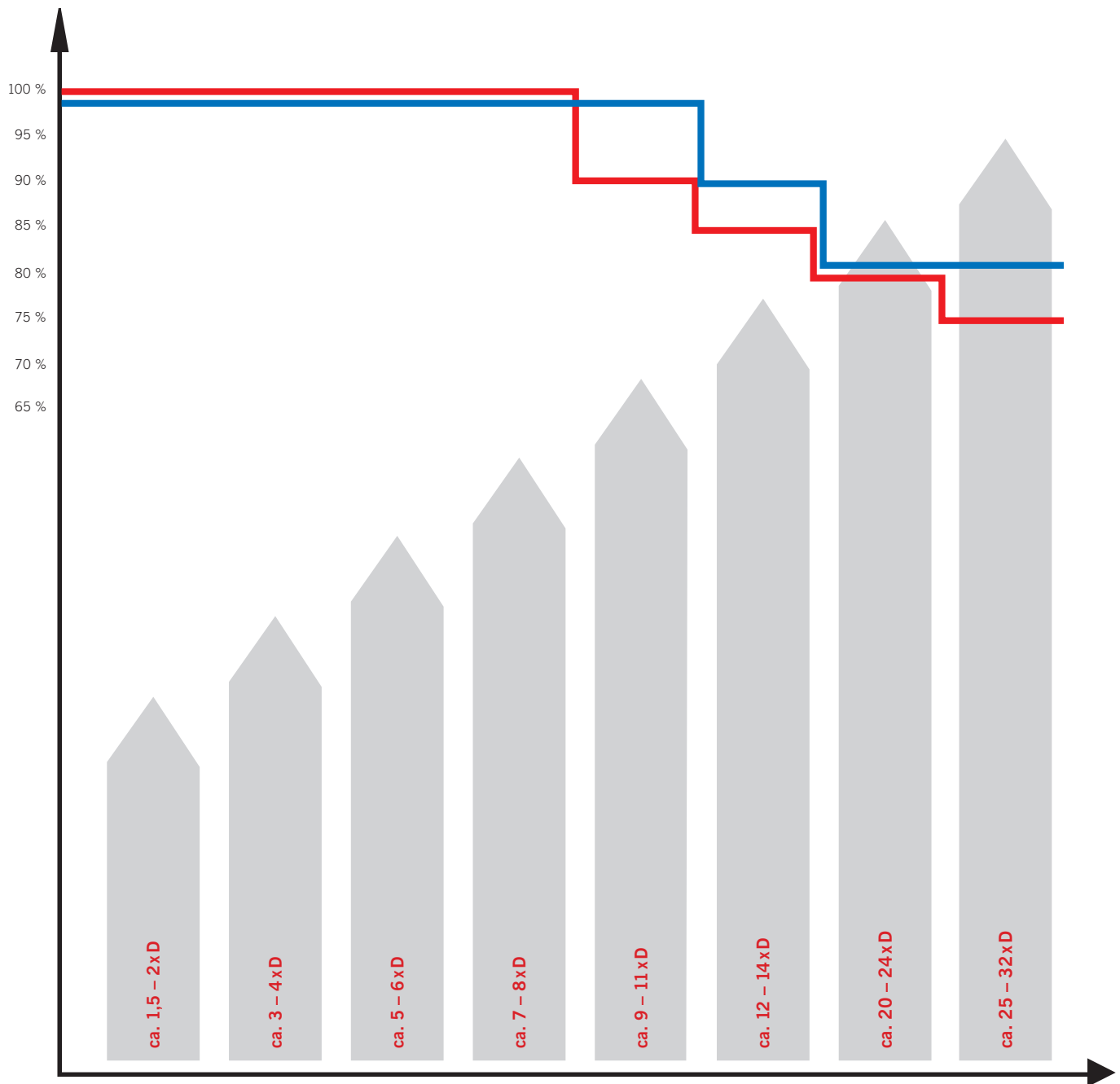

- **f** = **Vorschub** / Feed rate / Avanzamento
- **V_c** = **Schnittgeschwindigkeit** / Cutting speed / Velocità di taglio

9 - 11xD	> V _c x0,90
12 - 14xD	> V _c x0,85; f x0,90
20 - 24xD	> V _c x0,80; f x0,90
25 - 32xD	> V _c x0,75; f x0,80

Für Flatschneidsätze / For flat bottom inserts / Per inserti a fondo piano -F

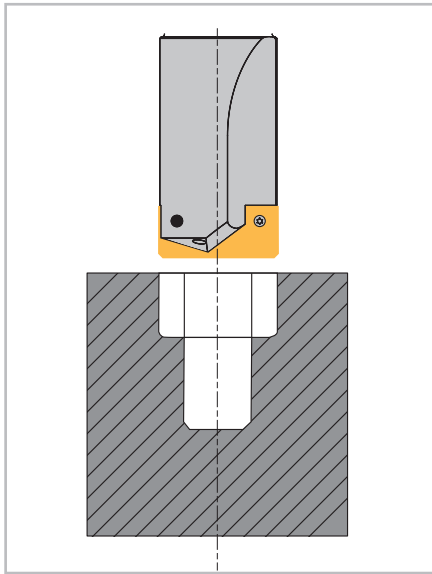

Die Flatschneidersätze sind ausschließlich in HSS5 lieferbar. Eingesetzt werden sie bei der Bohrungsgrundbearbeitung (z. B. für Schraubensenkungen). Es empfiehlt sich maximal Halter der Standardlänge zu verwenden.

The Flat Bottom Inserts are available in grade HSS5 only. The basic application is to drill the bottom of a hole (e.g. for screw countersinks). It is advisable to use holders of the standard length only.

Gli per fori a fondo piano sono disponibili nel grado HSS5. La principale applicazione di tali inserti è per la esecuzione del piano sul fondo di fori già eseguiti o per lamature poco profonde (alloggiamento testa vite). E'consigliabile usare corpi più corti possibile.

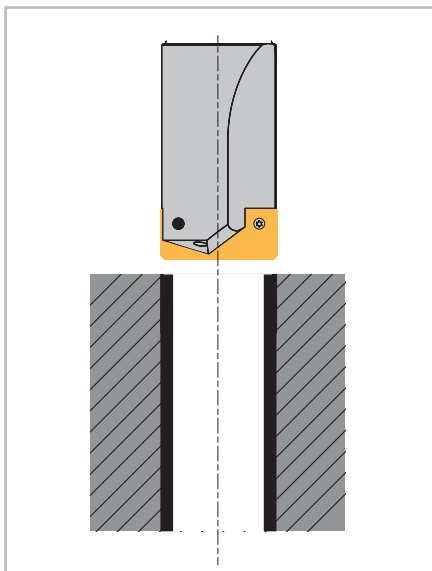

Bei der Verwendung zum Aufbohren sollten maximal mittellange Halter verwendet werden. Es ist außerdem darauf zu achten, dass der Durchmesserunterschied (Vorbohrdurchmesser zu Aufbohrdurchmesser) größer als die Eckenschutzfase ist. Die Flucht der aufgebohrten Bohrung entspricht der Flucht der Vorbohrung.

If counterboring only up to intermediate length holders should be used. It is necessary that the difference between the pre-existing hole and the counterbore diameter is bigger than the size of the cornerclips of the insert. The lead is nearly the same than the pre-existing hole.

Nell'utilizzo come barenatura di fori utilizzare corpi punta molto corti. Per un corretto funzionamento fare in modo che il sovrametallo superi la dimensione dello smusso sul tagliente dell'inserto. La rettilineità ottenuta è identica al preforo eseguito.

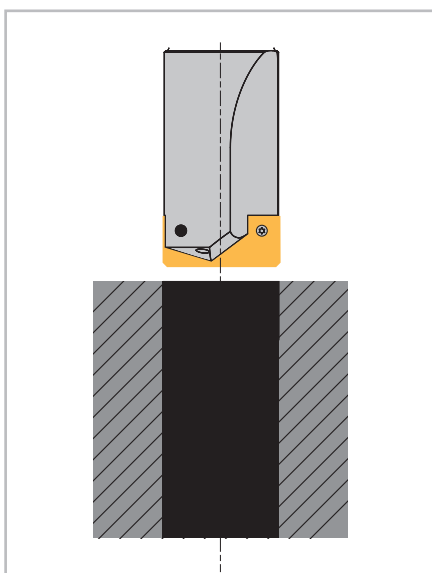

Ins Volle zu bohren funktioniert mit Abstrichen ausschließlich bei einfach zu zerspanenden Werkstoffen wie Aluminium oder Automatenstahl. Der Einsatz wird nur in Verbindung mit kurzen Haltern empfohlen.

To drill into solid it is only possible with limitations and easy to machine workpiece materials (e.g. aluminum and free machining steel). Short length holders should only be used.

L'esecuzione di fori dal pieno è possibile solo per materiali facili da lavorare (alluminio, acciaio non legato). Utilizzare sempre corpi extra corti.

Additional coolant for mose taper shank
 Fori addizionali per attacchi cono morse

Erweiterte DIN 228 Form BK / Extended DIN 228 form BK / Estensione DIN 228 forma BK

1

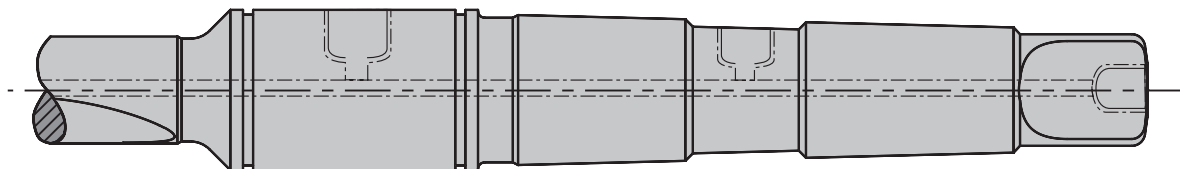

Es bestehen 3 Kühlmittloptionen:

- seitlich über den drehend gelagerten Kühlmittelring
- von hinten durch den Austreiblappen
- in der Mitte des Morsekegels

Im Auslieferungszustand ist das hintere Gewinde am Austreiblappen und das Gewinde am Kühlmittelringsitz durch Verschlusschrauben mit Innensechskant verschlossen. Je nach gewünschter Kühlmittloption an der Maschine können Sie entsprechend den Kühlmittelfluss bestimmen.

Three coolant options available:

- form the side with coolant ring
- through the shank
- through the morse taper

At first delivery, the tool is set up with a hexagon socket screw for coolant option "through tang". A second screw close the thread at the rotary coolant ring. According to machine requirements select the coolant supply.

Tre opzioni di refrigerante disponibili:

- dal lato con anello refrigerante
- attraverso il corpo
- dal lato del cono

Alla consegna, l'utensile viene fornito per l'uso "attraverso il corpo". Un grano chiude il passaggio per l'anello refrigerante ed un secondo grano chiude il passaggio dal cono. I grani possono venire spostati per l'uso richiesto.

Optional mit DIN ISO 9766-Schaft (-W) und rückseitigem Gewinde nach BSP ISO 7-1

Optional with DIN ISO 9766 shank (-W) for threaded coolant connection to BSP ISO 7-1

Versione corpi (-W) con foro filettato BSP ISO 7-1

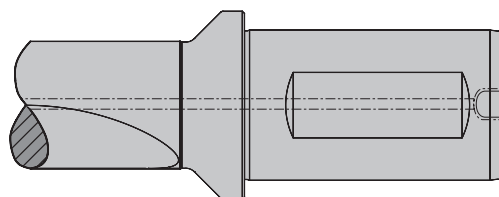

Verschleißfestigkeit und Zähigkeit

Wear resistance and Toughness

Resistenza all'usura e Tenacità

Hartmetall ist gegenüber den HSS-Sorten sehr verschleißfest, zugleich aber auch bruchempfindlich (siehe Abb.). Daher empfehlen wir den Einsatz von Hartmetallen nur unter stabilen Schnittbedingungen (kurze Bohrtiefen, stabile Spannung, gute Spannbildung).

As you can see, carbide against HSS-grades are very wear resistant, but also brittle. We recommend the use of carbide only under stable cutting conditions (short drill depths, rigid clamping, good chip formation).

Come si può notare I metalli duri rispetto agli HSS hanno molta più resistenza all'usura ma sono più fragili. Si raccomanda l'utilizzo die metalli duri solamente in abbinamento a stabili condizioni di lavorazione (fori corti, fissaggi rigidi, buona formazione di truciolo).

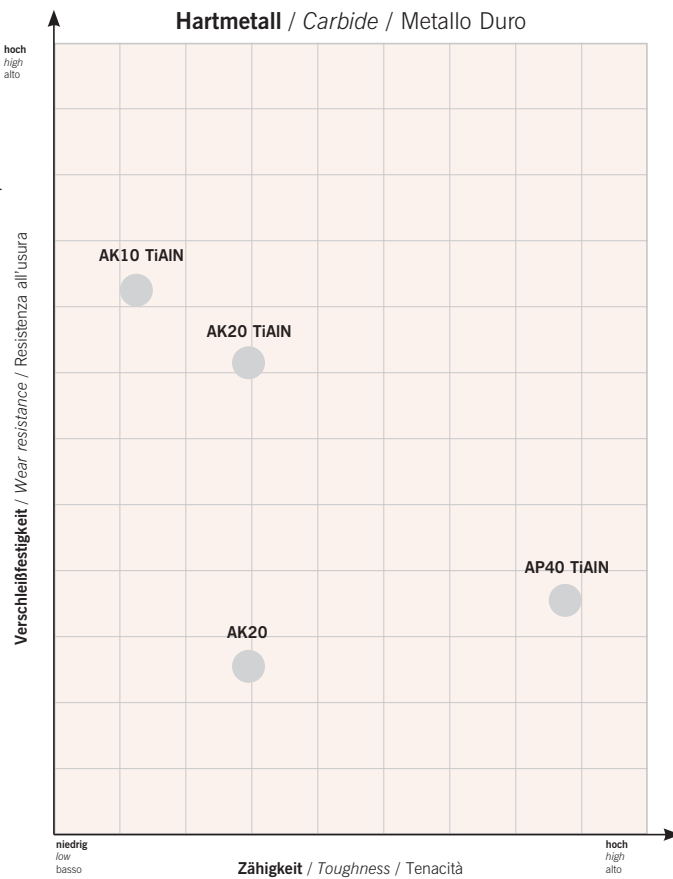
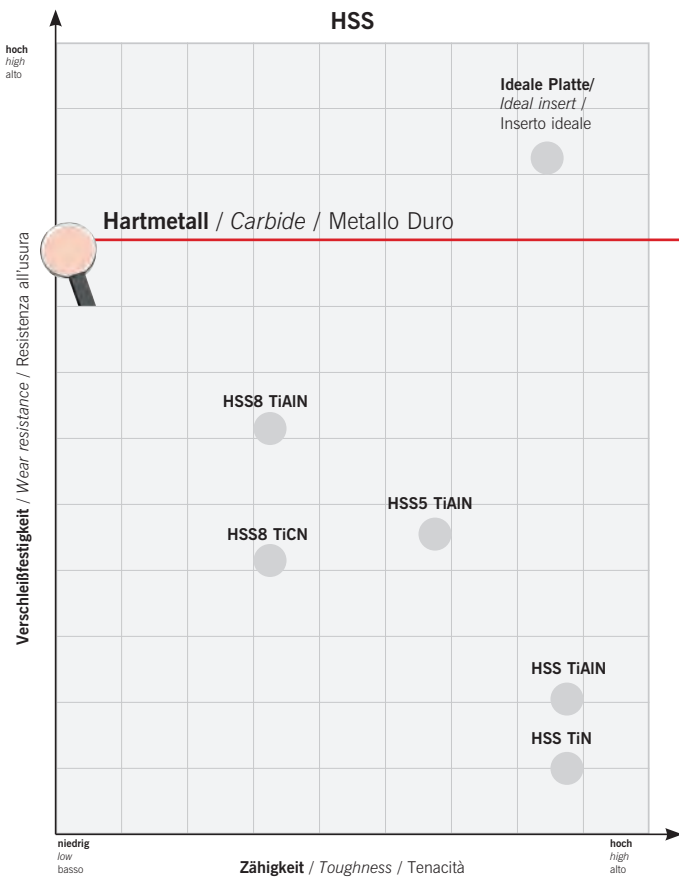

Langjährige Erfahrung

Im Bereich der Sonderwerkzeuge greift ARNO-Werkzeuge auf einen langjährigen Erfahrungsschatz zurück. Viele Unternehmen fertigen mit ARNO-Werkzeuge wesentlich effektiver und kostengünstiger. Ob es sich um Sonderbohrplatten oder komplexe Kombi-Bohrwerkzeuge handelt, speziell gefertigte Sonderwerkzeuge – kundenspezifisch entwickelt, flexibel, schnell und kostengünstig gefertigt – das steht für unsere zeitgemäße Fertigung.

Many years of experience

ARNO-Werkzeuge is using its many years of experience and expertise in special tooling. Many customers have improved efficiency using special inserts, complex combination tools or specific drilling tools. Our promise is fast, flexible and economical special solutions that work.

Tanti anni di esperienza

ARNO-Werkzeuge mette a disposizione i tanti anni di esperienza e perizia nella costruzione di utensili speciali. Molti die nostri clienti hanno migliorato la loro efficienza tramite l'utilizzo di inserti speciali, complessi utensili combinati o specifici utensili di foratura. La nostra promessa è una veloce, flessibile ed economica soluzione speciale per la vostra applicazione.

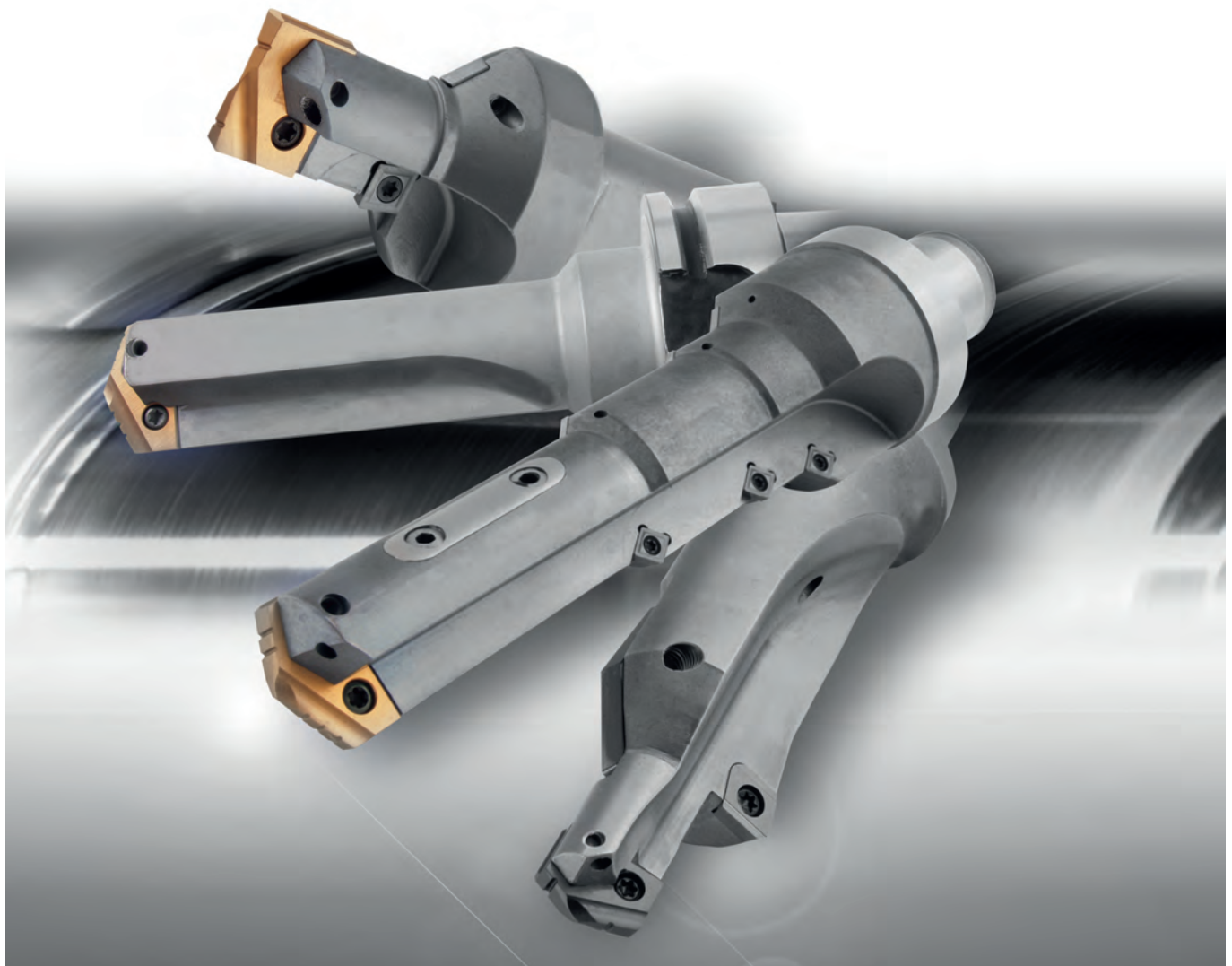

Für Fragen stehen wir Ihnen gerne zur Verfügung. Wir unterbreiten Ihnen ein individuelles Angebot ganz nach Ihren Anforderungen.

If you have any questions, please do not hesitate to contact us. We would be pleased to quote according to your specifications.

Per qualsiasi esigenza non esitate a contattarci. Vi preghiamo di chiamarci anche per un preventivo personalizzato in base alle vostre esigenze.

Karl-Heinz Arnold GmbH
Karlsbader Str. 4
D-73760 Ostfildern

☎: +49 (0)711 34 802 0
☎: +49 (0)711 34 802 130
info@arno.de
www.arno.de

ARNO (UK) Limited
Business Centre | Sugnall, Eccleshall
Staffordshire | ST21 6NF

☎: +44 01785 850 072
☎: +44 01785 850 076
sales@arno.de
www.arno-tools.co.uk

ARNO Italia S.r.l.
Via J. F. Kennedy 19
20871 Vimercate (MB)

☎: +39 039 68 52 101
☎: +39 039 60 83 724
info@arno-italia.it
www.arno-italia.it

SHARK-Drill²

- Systemvorstellung
- Bezeichnungssystem
- Werkzeugauswahl
- Trägerwerkzeuge
- Schneideinsätze
 - Geometriebeschreibung
 - Sortenbeschreibung
- Ersatzteile
- Schnittwerte
- Anwendungshinweise

SHARK-Drill²

- System introduction
- Designation system
- Tool shank options
- Drill holder
- Inserts
 - Geometry description
 - Grade description
- Spare parts
- Cutting data
- Application reference

SHARK-Drill²

- Caratteristiche del sistema **122 – 123**
- Sistema di numerazione **124**
- Tipologie di attacco utensile **125**
- Corpo punta **126 – 129**
- Inserti **130 – 137**
 - Descrizione delle Geometrie **130**
 - Descrizione delle Qualità **131**
- Ricambi **138**
- Parametri di taglio **139 – 141**
- Suggerimenti tecnici **142 – 145**



2

2

ARNO Schneidplattenbohrer SHARK-Drill²

ARNO Flanged holders SHARK-Drill²

ARNO Corpo punta SHARK-Drill²

2



Großer Bund-Ø: Geschliffen, für optimale Plananlage im Halter

Large location shoulder, ground for optimum holder location

Flangia di diametro maggiorato, rettificata per un migliore posizionamento e stabilità

Schaft nach DIN ISO 9766 mit durchgehender Spannfläche

Shank to DIN ISO 9766 with flat

Codolo DIN ISO 9766 con superficie di bloccaggio continua

Optimierter Auslauf der Spankammer im Bund

Swarf chamber run out into shoulder

Dimensione e forma ottimizzata delle eliche di scarico truciolo per una ridotta lunghezza totale

Beschichteter Halter für optimale Spanabfuhr und lange Lebensdauer

Coated holder for improved swarf evacuation and longer tool life

Speciale rivestimento del corpo punta per migliore scorrimento del truciolo e prolungata vita utensile

TORX-Plus® Schraube mit Niederzugseffekt der Bohrplatte

TORX-Plus® screw with more locking strength

TORX-Plus® vite con una incrementata forza di serraggio

Verbreiterte Spankammern zur Aufnahme eines höheren Späneolumens

Enhanced swarf chambers for more swarf volume

Innovativa forma delle eliche per un maggiore volume truciolo

Optimierter Kühlmittelaustritt

Optimized coolant outlet

Canali di adduzione refrigerante

HM-Schneideinsatz in beschichteter und unbeschichteter Ausführung. Ø 14 mm bis Ø 32 mm

Carbide inserts either coated or uncoated.

Ø 14 mm to Ø 32 mm drill diameter capability

Inserti in Metallo Duro micrograna, nudi e rivestiti da Ø 14 mm a Ø 32 mm

Einfache Identifikation durch umfangreiche Werkzeugbeschriftung:

- Bezeichnung
- Ø-Bereich
- Schraubenanzugsmoment
- Ersatzteile und Zubehör

Easy identification information:

- Description
- Diameter range
- Torque setting
- Spare part

Dati per un facile riconoscimento:

- Descrizione
- Gamma diametri di lavoro
- Forza di serraggio richiesta
- Codici ricambi

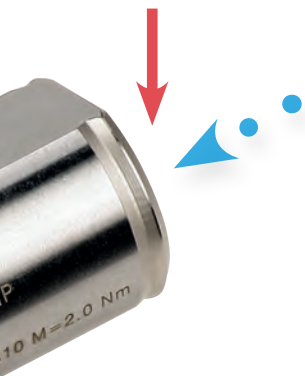
**Innere
Kühlmittelzufuhr***Through
tool coolant*Adduzione
interna

Höchste Bohrperformance durch neuartige Geometrie mit hervorragender Spankontrolle

Maximum drilling performance due to new geometry with excellent swarf control

Utensile sviluppato appositamente per elevate prestazioni di taglio

- **Flexibles System – ein Halter für mehrere Bohrdurchmesser**
- **Stabile und sichere Klemmung der Bohrplatte durch TORX-Plus® Schraube**
- **Schaft nach DIN ISO 9766 mit durchgehender Spannfläche**
- **Durchmesserbereich 14 mm bis 32 mm**
- **In 2xD, 3xD, 5xD und 8xD ab Lager verfügbar**
- **Stabiler Bund zur Aufnahme hoher Axialkräfte**
- **Ein optimierter Auslauf der Spankammer spart Auskraglänge**
- **Bewährter Spitzenanschliff für sehr gute Zentriereigenschaften und Bohrungsqualitäten**
- **HM-Schneideinsätze in beschichteter (PVD-TiAlN) und unbeschichteter Ausführung zur Bearbeitung von Stahl, rostfreien Stählen, NE-Metallen und Gusswerkstoffen**
- **Plattenwechsel unkompliziert und schnell, selbst im eingebauten Zustand möglich**

- *Flexible system – one holder for different drill diameters*
- *Robust and secure insert clamping with TORX-Plus® screws*
- *Shank to DIN ISO 9766 with full length flat*
- *Drill diameter range 14 mm – 32 mm*
- *Available for 2xD, 3xD, 5xD and 8xD drill depth*
- *Strong shank design for absorbing high axial forces*
- *The optimised run out of the swarf chambers reduces drill overhang length*
- *Improved drill point design for excellent centring and hole quality*
- *Coated (PVD-TiAlN) and un-coated carbide drilling inserts for machining steel, stainless steel, non-ferrous materials and cast materials*
- *Insert replacement uncomplicated and quick, can be changed whilst still in the machine*

- **Sistema flessibile – uno stelo per più diametri di lavoro**
- **Accoppiamento inserto preciso e robusto con vite TORX-Plus®**
- **Stelo cilindrico secondo norma DIN ISO 9766 con piano di bloccaggio**
- **Gamma diametri 14 mm – 32 mm**
- **Disponibile in versione 2xD, 3xD, 5xD e 8xD**
- **Stelo in acciaio da utensili da altissima qualità e flangia studiata per controllare al meglio le forze di taglio**
- **La speciale forma delle eliche è studiata anche per ridurre la lunghezza totale ed aumentare la rigidità della punta in lavoro**
- **Migliorata forma del nocciolo di centraggio per una eccellente foratura e finitura foro**
- **Rivestimenti PVD-TiAlN per la foratura di acciai, stampati, acciai inossidabili, inserti in metallo duro micrograna per forare materiali non ferrosi o ghise**
- **Forma dei piani di appoggio inserto ampi per contrastare le elevate forze assiali e la durata della sede nel tempo**



2

Designation system
Sistema di numerazione

Trägerwerkzeug / Drill holder / Corpo punta



2

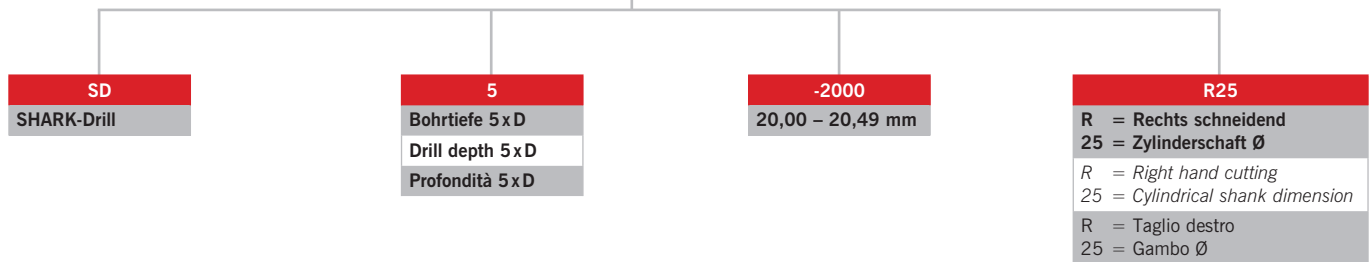

Schneideinsätze / Inserts / Inserti

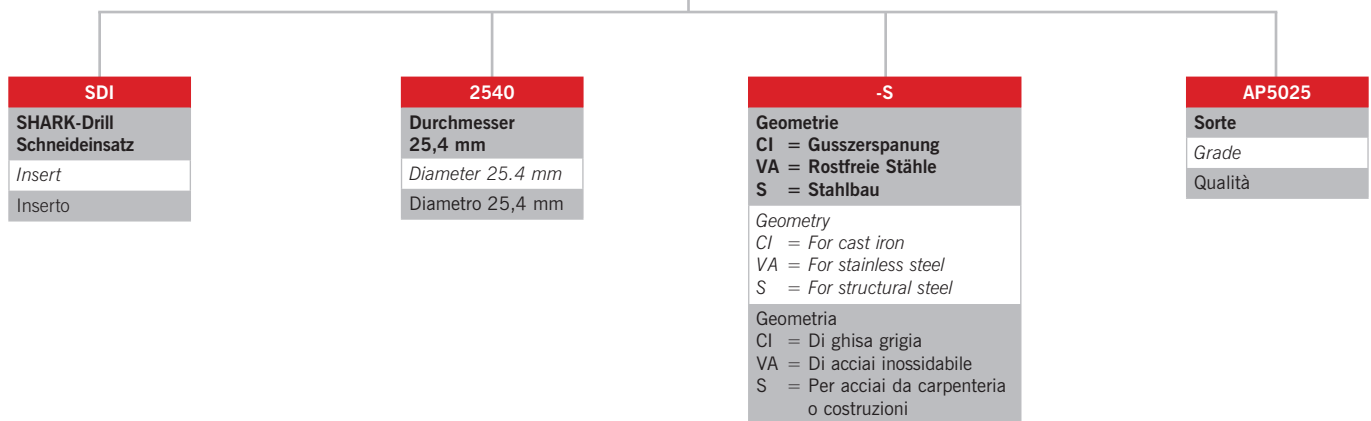
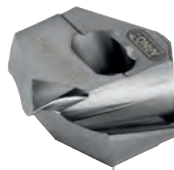



2xD Bohrtiefe / *Drill depth* / Profondità foratura

Ø 14 – 32 mm

126



3xD Bohrtiefe / *Drill depth* / Profondità foratura

Ø 14 – 32 mm

127

5xD Bohrtiefe / *Drill depth* / Profondità foratura

Ø 14 – 32 mm

128

8xD Bohrtiefe / *Drill depth* / Profondità foratura

Ø 14 – 31,5 mm

129

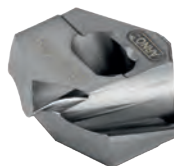

Schneideinsätze / *Inserts* / Inserti

132 – 137

Flanged holders
Corpo punta

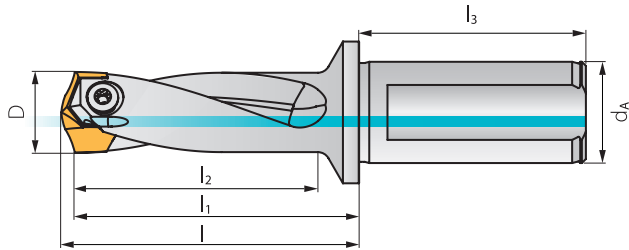
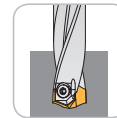
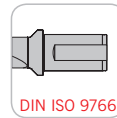

2xD Trägerwerkzeug / Drill holder / Corpo punta

Bezeichnung Designation Articolo	D von Ø... bis Ø from Ø... to Ø da Ø... a Ø...	l	l ₁	l ₂ Bohrtiefe max. Maximum drill depth Massima profondità di foratura	l ₃	d _A
SD2-1400R20	14,00 – 14,49	54,50	42	28,0	50	20
SD2-1500R20	15,00 – 15,49	57,60	45	30,0	50	20
SD2-1600R20	16,00 – 16,49	60,50	48	32,0	50	20
SD2-1700R20	17,00 – 17,49	63,35	52	34,0	50	20
SD2-1800R25	18,00 – 18,49	67,75	54	36,0	56	25
SD2-1900R25	19,00 – 19,49	70,63	57	38,0	56	25
SD2-2000R25	20,00 – 20,49	73,51	60	40,0	56	25
SD2-2100R25	21,00 – 21,49	76,35	63	42,0	56	25
SD2-3150R32	31,50 – 32,00	108,49	94,5	63,0	60	32

HINWEIS: Trägerwerkzeuge werden mit Klemmschrauben und Schlüssel geliefert.

INFORMATION: Holders will be supplied with clamping screws and key.

NOTA: L'utensile é fornito completo di vite e chiave.

Flanged holders
Corpo punta

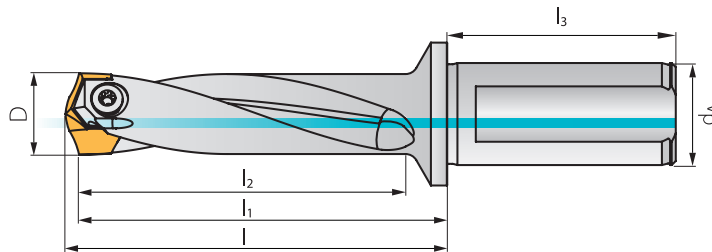
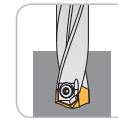
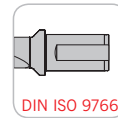

3xD Trägerwerkzeug / Drill holder / Corpo punta

Bezeichnung Designation Articolo	D von Ø... bis Ø from Ø... to Ø da Ø... a Ø...	l	l ₁	l ₂ Bohrtiefe max. Maximum drill depth Massima profondità di foratura	l ₃	d _A
SD3-1400R20	14,00 – 14,49	68,78	56	42,0	50	20
SD3-1450R20	14,50 – 14,99	70,71	58	43,5	50	20
SD3-1500R20	15,00 – 15,49	72,61	60	45,0	50	20
SD3-1550R20	15,50 – 15,99	74,55	62	46,5	50	20
SD3-1600R20	16,00 – 16,49	76,48	64	48,0	50	20
SD3-1650R20	16,50 – 16,99	78,40	66	49,5	50	20
SD3-1700R20	17,00 – 17,49	80,32	68	51,0	50	20
SD3-1750R20	17,50 – 17,99	82,32	70	52,5	50	20
SD3-1800R25	18,00 – 18,49	85,78	72	54,0	56	25
SD3-1850R25	18,50 – 18,99	87,71	74	55,5	56	25
SD3-1900R25	19,00 – 19,49	89,63	76	57,0	56	25
SD3-1950R25	19,50 – 19,99	91,53	78	58,5	56	25
SD3-2000R25	20,00 – 20,49	93,52	80	60,0	56	25
SD3-2050R25	20,50 – 20,99	95,52	82	61,5	56	25
SD3-2100R25	21,00 – 21,49	97,36	84	63,0	56	25
SD3-2150R25	21,50 – 21,99	99,29	86	64,5	56	25
SD3-2200R25	22,00 – 22,49	101,25	88	66,0	56	25
SD3-2250R25	22,50 – 22,99	103,19	90	67,5	56	25
SD3-2300R25	23,00 – 23,49	105,09	92	69,0	56	25
SD3-2350R25	23,50 – 23,99	107,03	94	70,5	56	25
SD3-2400R32	24,00 – 24,49	110,99	96	72,0	60	32
SD3-2450R32	24,50 – 24,99	112,93	98	73,5	60	32
SD3-2500R32	25,00 – 25,49	114,83	100	75,0	60	32
SD3-2550R32	25,50 – 25,99	116,76	102	76,5	60	32
SD3-2600R32	26,00 – 26,49	118,68	104	78,0	60	32
SD3-2650R32	26,50 – 26,99	120,62	106	79,5	60	32
SD3-2700R32	27,00 – 27,49	122,52	108	81,0	60	32
SD3-2750R32	27,50 – 27,99	124,45	110	82,5	60	32
SD3-2800R32	28,00 – 28,49	126,47	112	84,0	60	32
SD3-2850R32	28,50 – 28,99	128,40	114	85,5	60	32
SD3-2900R32	29,00 – 29,49	130,30	116	87,0	60	32
SD3-2950R32	29,50 – 29,99	132,19	118	88,5	60	32
SD3-3000R32	30,00 – 30,49	134,21	120	90,0	60	32
SD3-3050R32	30,50 – 30,99	136,14	122	91,5	60	32
SD3-3100R32	31,00 – 31,49	138,03	124	93,0	60	32
SD3-3150R32	31,50 – 32,00	139,99	126	94,5	60	32

HINWEIS: Trägerwerkzeuge werden mit Klemmschrauben und Schlüssel geliefert.

INFORMATION: Holders will be supplied with clamping screws and key.

NOTA: L'utensile é fornito completo di vite e chiave.

Flanged holders
Corpo punta

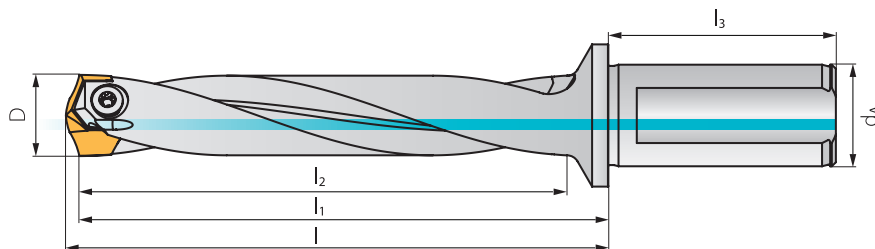
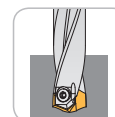

5xD Trägerwerkzeug / Drill holder / Corpo punta

Bezeichnung Designation Articolo	D von Ø... bis Ø from Ø... to Ø da Ø... a Ø...	l	l ₁	l ₂ Bohrtiefe max. Maximum drill depth Massima profondità di foratura	l ₃	d _A
SD5-1400R20	14,00 – 14,49	96,78	84	70,0	50	20
SD5-1450R20	14,50 – 14,99	99,71	87	72,5	50	20
SD5-1500R20	15,00 – 15,49	102,61	90	75,0	50	20
SD5-1550R20	15,50 – 15,99	105,55	93	77,5	50	20
SD5-1600R20	16,00 – 16,49	108,48	96	80,0	50	20
SD5-1650R20	16,50 – 16,99	111,40	99	82,5	50	20
SD5-1700R20	17,00 – 17,49	114,32	102	85,0	50	20
SD5-1750R20	17,50 – 17,99	117,32	105	87,5	50	20
SD5-1800R25	18,00 – 18,49	121,78	108	90,0	56	25
SD5-1850R25	18,50 – 18,99	124,71	111	92,5	56	25
SD5-1900R25	19,00 – 19,49	127,63	114	95,0	56	25
SD5-1950R25	19,50 – 19,99	130,53	117	97,5	56	25
SD5-2000R25	20,00 – 20,49	133,52	120	100,0	56	25
SD5-2050R25	20,50 – 20,99	136,45	123	102,5	56	25
SD5-2100R25	21,00 – 21,49	139,36	126	105,0	56	25
SD5-2150R25	21,50 – 21,99	142,29	129	107,5	56	25
SD5-2200R25	22,00 – 22,49	145,25	132	110,0	56	25
SD5-2250R25	22,50 – 22,99	148,19	135	112,5	56	25
SD5-2300R25	23,00 – 23,49	151,09	138	115,0	56	25
SD5-2350R25	23,50 – 23,99	154,03	141	117,5	56	25
SD5-2400R32	24,00 – 24,49	158,99	144	120,0	60	32
SD5-2450R32	24,50 – 24,99	161,93	147	122,5	60	32
SD5-2500R32	25,00 – 25,49	164,83	150	125,0	60	32
SD5-2550R32	25,50 – 25,99	167,76	153	127,5	60	32
SD5-2600R32	26,00 – 26,49	170,68	156	130,0	60	32
SD5-2650R32	26,50 – 26,99	173,62	159	132,5	60	32
SD5-2700R32	27,00 – 27,49	176,52	162	135,0	60	32
SD5-2750R32	27,50 – 27,99	179,45	165	137,5	60	32
SD5-2800R32	28,00 – 28,49	182,47	168	140,0	60	32
SD5-2850R32	28,50 – 28,99	185,4	171	142,5	60	32
SD5-2900R32	29,00 – 29,49	188,3	174	145,0	60	32
SD5-2950R32	29,50 – 29,99	191,19	177	147,5	60	32
SD5-3000R32	30,00 – 30,49	194,21	180	150,0	60	32
SD5-3050R32	30,50 – 30,99	197,14	183	152,5	60	32
SD5-3100R32	31,00 – 31,49	200,03	186	155,0	60	32
SD5-3150R32	31,50 – 32,00	202,99	189	157,5	60	32

HINWEIS: Trägerwerkzeuge werden mit Klemmschrauben und Schlüssel geliefert.

INFORMATION: Holders will be supplied with clamping screws and key.

NOTA: L'utensile é fornito completo di vite e chiave.

Flanged holders
Corpo punta

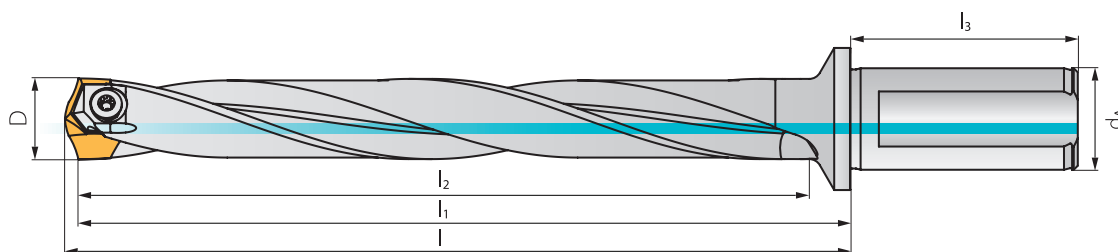

8xD Trägerwerkzeug / Drill holder / Corpo punta

Bezeichnung Designation Articolo	D von Ø... bis Ø from Ø... to Ø da Ø... a Ø...	l	l ₁	l ₂ Bohrtiefe max. Maximum drill depth Massima profondità di foratura	l ₃	d _A
SD8-1400R20	14,00 – 14,49	138,75	126,0	112,0	50	20
SD8-1500R20	15,00 – 15,49	147,57	135,0	120,0	50	20
SD8-1600R20	16,00 – 16,49	156,44	144,0	128,0	50	20
SD8-1650R20	16,50 – 16,99	160,86	148,5	132,0	50	20
SD8-1700R20	17,00 – 17,49	165,32	153,0	136,0	50	20
SD8-1750R20	17,50 – 17,99	169,80	157,5	140,0	50	20
SD8-1800R25	18,00 – 18,49	175,71	162,0	144,0	56	25
SD8-1900R25	19,00 – 19,49	184,58	171,0	152,0	56	25
SD8-2000R25	20,00 – 20,49	193,47	180,0	160,0	56	25
SD8-2100R25	21,00 – 21,49	202,30	189,0	168,0	56	25
SD8-2200R25	22,00 – 22,49	211,20	198,0	176,0	56	25
SD8-2300R25	23,00 – 23,49	220,04	207,0	184,0	56	25
SD8-2400R32	24,00 – 24,49	231,20	216,0	192,0	60	32
SD8-2500R32	25,00 – 25,49	239,80	225,0	200,0	60	32
SD8-2600R32	26,00 – 26,49	248,65	234,0	208,0	60	32
SD8-2700R32	27,00 – 27,49	257,50	243,0	216,0	60	32
SD8-2800R32	28,00 – 28,49	266,43	252,0	224,0	60	32
SD8-2900R32	29,00 – 29,49	275,25	261,0	232,0	60	32
SD8-3000R32	30,00 – 30,49	284,16	270,0	240,0	60	32
SD8-3100R32	31,00 – 31,49	292,99	279,0	248,0	60	32

HINWEIS: Trägerwerkzeuge werden mit Klemmschrauben und Schlüssel geliefert.

INFORMATION: Holders will be supplied with clamping screws and key.

NOTA: L'utensile é fornito completo di vite e chiave.

Geometry description

Descrizione delle Geometrie

Universelle Geometrie zur Bearbeitung von Stählen und mit Einschränkungen bei rostfreien Stählen. Sie zeichnet sich aus durch gutes Zentrierverhalten sowie gute Spanausbringung.

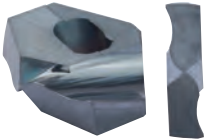

Universal geometry for drilling steel and to an extent also stainless steel, provides excellent self-centring as well as secure swarf evacuation.

Geometria universale per la foratura di tutti gli acciai sia legati che debolmente legati. Limitatamente anche per alcuni acciai inossidabili. Ottimo controllo e formazione di truciolo specialmente su acciai teneri o non legati.

-CI

Spezielle Geometrie für die Gusszerspanung (Grauguss). Die Schneidplatte weist eine vergrößerte Eckenschutzfase auf. Sie zeichnet sich durch ein sehr gutes Zentrierverhalten, höchste Bohrungsgüten und hohe Standzeiten aus. Minimalste Grat- und Lochausbrüche bei Durchgangsbohrungen runden die Eigenschaften ab.

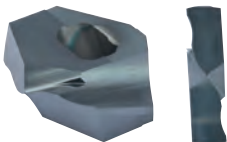

-CI

Specifically for cast iron. The insert has increased edge protection. It centres extremely well, provides good hole quality and offers good tool life. When drilling through holes the geometry develop nearly no exit burrs.

-CI

Geometria specifica per la lavorazione di ghisa grigia. L'inserto riporta una fase tagliente molto maggiore sullo spigolo esterno. Questo garantisce una maggior durata e resistenza all'usura. La geometria garantisce un ottimo centraggio da pieno, una buona qualità superficiale del foro e rettilineità. La riduzione delle bavure in uscita e le ridotte rotture completano le funzioni di questa geometria.

-VA

Spezielle Geometrie für die Zerspanung von VA-Stählen. Der Spanwinkel an der Ausspitzung sorgt zusammen mit dem speziell abgestimmten Substrat für ein optimales Zentrierverhalten. Die Bohrungsqualität ist gleichmäßig und gut, die Schneidplatte hat sowohl ein weiches Schneidverhalten als auch einen kontrollierten Spanbruch.

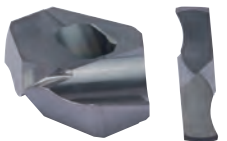

-VA

Specifically for stainless steel drilling. The drill point, carbide substrate and coating is an ideal combination offering optimum centring, good hole quality, soft cutting action as well as excellent swarf control.

-VA

Geometria specifica per la lavorazione di acciai inossidabili. Gli angoli di spoglia positivamente assicurano assieme al metallo duro di base la combinazione ottimale per una ottima centratura del foro, un taglio dolce, un ridotto sforzo di taglio, un giusto controllo truciolo ed una buona qualità superficiale del foro.

-S

Diese spezielle Geometrie gleicht die hohen Ansprüche im Stahlbau, wie z. B. relativ große Auskraglängen, schwierige Rahmenbedingungen oder große Chargenschwankungen aus. Durch die spezielle S-Ausspitzung weist die Schneidplatte ein sehr gutes Zentrierverhalten auf. Sie zeichnet sich durch eine hervorragende Bohrungsqualität aus.

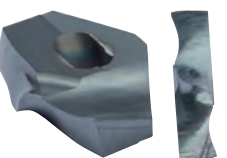

-S

This geometry is designed to satisfy the demands of especially the fabrication industry where relative long overhang, poor machining conditions and vibrations are often present. The S design drill point offer very good tool centring and also excellent hole quality.

-S

Questa particolare geometria è studiata per quelle condizioni di lavoro dove le profondità di foratura sono minime ma le sporgenze sono elevate, gli staffaggi dei pezzi instabili, la qualità del materiale non sempre costante. Caratteristiche che si ritrovano in carpenterie, costruzioni edili in acciaio, dove anche il numero di fori è elevato. La Geometria -S garantisce una buona centratura sulla superficie non perfetta del pezzo, ridotte forze di taglio, una buona precisione ed un'ottima qualità superficiale. L'incremento della vita inserto completa le caratteristiche di questa geometria.

Hartmetall beschichtet / Carbide grade coated / Metallo duro rivestito**AP5025**

PVD-Mehrlagenbeschichtung, HM-Feinkorn. Das Hauptanwendungsgebiet dieser Sorte ist die Bearbeitung von Stahl. In der Nebenanwendung ist sie auch geeignet für die Bearbeitung von rostfreien Stählen und Gusswerkstoffen. Eine sehr universell einsetzbare Sorte mit hoher Hitze- und Oxidationsbeständigkeit.

PVD-Multilayer coating, fine grain carbide. The main application area for this grade is the machining of steel. Also suitable for machining stainless steel and cast iron. A very universal grade with high temperature and oxygenation resistance.

Metallo duro micrograna, rivestimento multistrato PVD TiAlN. Grado studiato per lavorare materiali acciai. Idoneo anche alla lavorazione di acciai inossidabili. Un grado universale molto resistente alle elevate temperature ed alla ossidazione.

AK5015

Durch das harte Substrat eignet sich diese Sorte besonders zur Bearbeitung von Eisen-guss, auch bei harten Gusskrusten und unregelmäßigen Spantiefen. Sie besitzt eine exzellente Verschleißfestigkeit und eine geringe Neigung zur Aufbauschneidenbildung.

The hard substrate is especially suitable for cast materials also hard cast and unusual drill depths. The grade is very wear resistant as well as resistant to build up edge.

Qualità caratterizzata dalla elevata durezza e resistenza all'usura. Rivestimento specifico per una ottima resistenza alle alte temperature e per la lavorazione di Ghise grigie anche con croste.

AM5040

Sorte für die Bearbeitung von rostfreien und warmfesten Stählen. Sie zeichnet sich durch ein weiches Schneidverhalten und kontrollierten Spanbruch aus. Durch die hohe Zähigkeit ergibt sich ein geringer Verschleiß. Variierende Schnitttiefen oder unterbrochene Schnitte können gut bearbeitet werden.

The grade for drilling stainless steel, soft cutting and with good swarf control. The high toughness ensures low wear. Machines well at varied cutting depths and interrupted cutting.

Grado specifico per la lavorazione di acciai inossidabili e leghe resistenti al calore. Caratterizzata da una ottima resistenza alle alte temperature, una base tenace di metallo duro garantisce una elevata durata mantenendo un tagliente sempre vivo anche su tagli interrotti.

Hartmetall unbeschichtet / Carbide grade uncoated / Metallo duro non rivestito**AK1025**

HM-Feinkorn, unbeschichtet. Zur Bearbeitung von Aluminium und Nichteisenmetallen. Hervorragend geeignet als Basis-Substrat für kundenspezifische Beschichtungslösungen.

Fine grain carbide, uncoated. For machining aluminium and non-ferrous materials. Excellent also as base grade for customer specific coating solutions.

Metallo duro micrograna, non rivestito. Per la foratura di alluminio e materiali non ferrosi. Eccellente anche come grado base per specifici rivestimenti ad hoc.

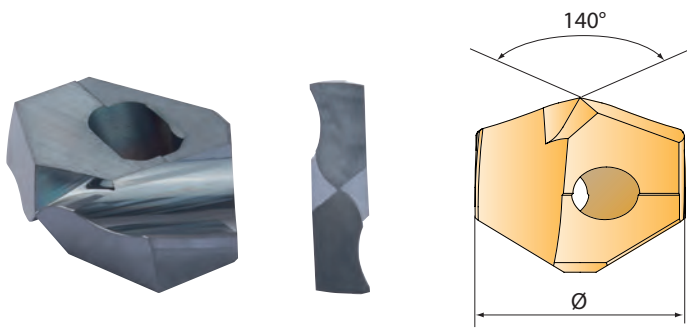

Schneideinsätze / Inserts / Inserti

2

Bezeichnung Designation Articolo	Durchmesser			beschichtet coated rivestito	unbeschichtet uncoated non rivestito
	[mm]	[decimal]	[inch]	AP5025	AK1025
SDI1400	14,0	0,5512"		●	●
SDI1410	14,1	0,5551"		●	●
SDI1420	14,2	0,5591"		●	●
SDI1429	14,29	0,5626"	9/16	●	●
SDI1450	14,5	0,5709"		●	●
SDI1468	14,68	0,5780"	37/64	●	●
SDI1480	14,8	0,5827"		●	●
SDI1500	15,0	0,5906"		●	●
SDI1508	15,08	0,5937"	19/32	●	●
SDI1530	15,3	0,6024"		●	●
SDI1550	15,5	0,6102"		●	●
SDI1580	15,8	0,6220"		●	●
SDI1587	15,87	0,6248"	5/8	●	●
SDI1600	16,0	0,6299"		●	●
SDI1609	16,09	0,6335"		●	●
SDI1627	16,27	0,6406"	41/64	●	●
SDI1650	16,5	0,6496"		●	●
SDI1667	16,67	0,6563"	21/32	●	●
SDI1680	16,8	0,6614"		●	●
SDI1700	17,0	0,6693"		●	●
SDI1707	17,07	0,6720"	43/64	●	●
SDI1746	17,46	0,6874"	11/16	●	●
SDI1750	17,5	0,6890"		●	●
SDI1780	17,8	0,7008"		●	●
SDI1786	17,86	0,7031"	21/64	●	●
SDI1800	18,0	0,7087"		●	●
SDI1810	18,1	0,7126"		●	●
SDI1826	18,26	0,7189"	24/32	●	●
SDI1850	18,5	0,7283"		●	●
SDI1865	18,65	0,7343"	47/64	●	●
SDI1880	18,8	0,7402"		●	●
SDI1900	19,0	0,7480"		●	●
SDI1905	19,05	0,7500"	3/4	●	●
SDI1927	19,27	0,7587"		●	●
SDI1945	19,45	0,7657"	49/64	●	●
SDI1950	19,5	0,7677"		●	●
SDI1980	19,8	0,7795"		●	●
SDI1984	19,84	0,7811"	25/32	●	●
SDI2000	20,0	0,7874"		●	●
SDI2024	20,24	0,7969"	51/64	●	●

Schneideinsätze / Inserts / Inserti

Bezeichnung Designation Articolo	Durchmesser			beschichtet coated rivestito	unbeschichtet uncoated non rivestito
	[mm]	[decimal]	[inch]	AP5025	AK1025
SDI2050	20,5	0,8071"		●	●
SDI2064	20,64	0,8126"	13/16	●	●
SDI2070	20,7	0,8150"		●	●
SDI2100	21,0	0,8268"		●	●
SDI2143	21,43	0,8437"	27/32	●	●
SDI2150	21,5	0,8465"		●	●
SDI2170	21,7	0,8543"		●	●
SDI2183	21,83	0,8594"	55/64	●	●
SDI2200	22,0	0,8661"		●	●
SDI2223	22,23	0,8750"	7/8	●	●
SDI2250	22,5	0,8858"		●	●
SDI2262	22,62	0,8906"	56/64	●	●
SDI2270	22,7	0,8937"		●	●
SDI2300	23,0	0,9055"		●	●
SDI2342	23,42	0,9220"	59/64	●	●
SDI2350	23,5	0,9252"		●	●
SDI2370	23,7	0,9331"		●	●
SDI2381	23,81	0,9374"	15/16	●	●
SDI2400	24,0	0,9449"		●	●
SDI2421	24,21	0,9531"		●	●
SDI2440	24,4	0,9606"		●	●
SDI2450	24,5	0,9646"		●	●
SDI2461	24,61	0,9688"	31/32	●	●
SDI2470	24,7	0,9724"		●	●
SDI2500	25,0	0,9843"	63/64	●	●
SDI2540	25,4	1,0000"	1	●	●
SDI2567	25,67	1,0106"		●	●
SDI2580	25,8	1,0157"	1 1/64	●	●
SDI2600	26,0	1,0236"		●	●
SDI2619	26,19	1,0311"	1 1/32	●	●
SDI2650	26,5	1,0433"		●	●
SDI2659	26,59	1,0469"	1 3/64	●	●
SDI2700	27,0	1,0630"	1 1/16	●	●
SDI2720	27,2	1,0709"		●	●
SDI2750	27,5	1,0827"		●	●
SDI2778	27,78	1,0938"	1 3/32	●	●
SDI2800	28,0	1,1024"		●	●
SDI2818	28,18	1,1094"	1 7/64	●	●
SDI2850	28,5	1,1220"		●	●
SDI2858	28,58	1,1252"	1 1/8	●	●
SDI2900	29,0	1,1417"		●	●
SDI2937	29,37	1,1563"	1 5/32	●	●
SDI2950	29,5	1,1614"		●	●
SDI2977	29,77	1,1720"	1 11/64	●	●
SDI3000	30,0	1,1811"		●	●
SDI3016	30,16	1,1874"	1 3/16	●	●
SDI3050	30,5	1,2008"		●	●
SDI3056	30,56	1,2031"	1 13/64	●	●
SDI3096	30,96	1,2189"	1 7/32	●	●
SDI3100	31,0	1,2205"		●	●
SDI3150	31,5	1,2402"		●	●
SDI3175	31,75	1,2500"	1 1/4	●	●
SDI3200	32,0	1,2598"		●	●

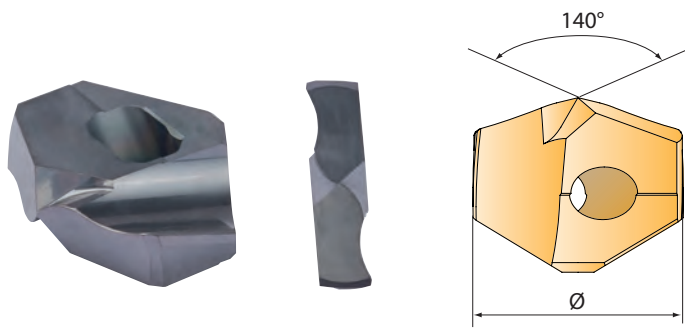

CI Schneideinsätze / Inserts / Inserti

2

Bezeichnung Designation Articolo	Durchmesser			beschichtet coated rivestito
	[mm]	[decimal]	[inch]	AK5015
SDI1400-CI	14,0	0,5512"		●
SDI1429-CI	14,29	0,5630"	9/16	●
SDI1450-CI	14,5	0,5709"		●
SDI1468-CI	14,68	0,5780"	37/64	●
SDI1500-CI	15,0	0,5906"		●
SDI1550-CI	15,5	0,6102"		●
SDI1587-CI	15,87	0,6248"	5/8	●
SDI1600-CI	16,0	0,6299"		●
SDI1627-CI	16,27	0,6406"	41/64	●
SDI1650-CI	16,5	0,6496"		●
SDI1667-CI	16,67	0,6563"	21/32	●
SDI1700-CI	17,0	0,6693"		●
SDI1746-CI	17,46	0,6874"	11/16	●
SDI1750-CI	17,5	0,6890"		●
SDI1786-CI	17,86	0,7030"	45/64	●
SDI1800-CI	18,0	0,7087"		●
SDI1826-CI	18,26	0,7189"	23/32	●
SDI1850-CI	18,5	0,7283"		●
SDI1865-CI	18,65	0,7343"	47/64	●
SDI1900-CI	19,0	0,7480"		●
SDI1905-CI	19,05	0,7500"	3/4	●
SDI1950-CI	19,5	0,7677"		●
SDI2000-CI	20,0	0,7874"		●
SDI2050-CI	20,5	0,8071"		●
SDI2064-CI	20,64	0,8126"	13/16	●
SDI2100-CI	21,0	0,8268"		●
SDI2143-CI	21,43	0,8437"	27/32	●
SDI2150-CI	21,5	0,8465"		●
SDI2200-CI	22,0	0,8661"		●
SDI2223-CI	22,23	0,8752"	7/8	●
SDI2250-CI	22,5	0,8858"		●
SDI2300-CI	23,0	0,9055"		●
SDI2342-CI	23,42	0,9220"	59/64	●
SDI2350-CI	23,5	0,9252"		●
SDI2381-CI	23,81	0,9374"	15/16	●
SDI2400-CI	24,0	0,9449"		●
SDI2450-CI	24,5	0,9646"		●
SDI2461-CI	24,61	0,9689"	31/32	●
SDI2500-CI	25,0	0,9843"	63/64	●
SDI2540-CI	25,4	1,0000"	1	●

CI Schneideinsätze / Inserts / Inserti

Bezeichnung <i>Designation</i> Articolo	Durchmesser			beschichtet <i>coated</i> <i>rivestito</i>
	[mm]	[decimal]	[inch]	AK5015
SDI2550-CI	25,5	1,0039"		●
SDI2580-CI	25,8	1,0157"	1 1/64	●
SDI2600-CI	26,0	1,0236"		●
SDI2619-CI	26,19	1,0311"	1 1/32	●
SDI2650-CI	26,5	1,0433"		●
SDI2700-CI	27,0	1,0630"	1 1/16	●
SDI2750-CI	27,5	1,0827"		●
SDI2800-CI	28,0	1,1024"		●
SDI2850-CI	28,5	1,1220"		●
SDI2858-CI	28,58	1,1252"	1 1/8	●
SDI2900-CI	29,0	1,1417"		●
SDI2937-CI	29,37	1,1563"	1 5/32	●
SDI2950-CI	29,5	1,1614"		●
SDI3000-CI	30,0	1,1811"		●
SDI3016-CI	30,16	1,1874"	1 3/16	●
SDI3050-CI	30,5	1,2008"		●
SDI3100-CI	31,0	1,2205"		●
SDI3150-CI	31,5	1,2402"		●
SDI3175-CI	31,75	1,2500"	1 1/4	●
SDI3200-CI	32,0	1,2598"		●

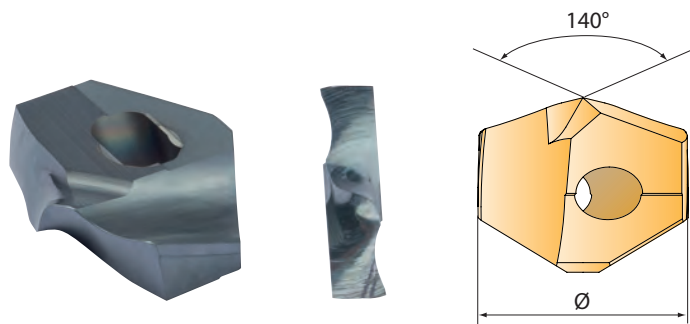

S Schneideinsätze / Inserts / Inserti

Bezeichnung <i>Designation</i> Articolo	Durchmesser			beschichtet <i>coated</i> <i>rivestito</i>
	[mm]	[decimal]	[inch]	AP5025
SDI1400-S	14,0	0,5512"		●
SDI1800-S	18,0	0,7087"		●
SDI2200-S	22,0	0,8661"		●
SDI2400-S	24,0	0,9449"		●
SDI2500-S	25,0	0,9843"	63/64	●
SDI2600-S	26,0	1,0236"		●
SDI2700-S	27,0	1,0630"	1 1/16	●
SDI2900-S	29,0	1,1417"		●
SDI3200-S	32,0	1,2598"		●

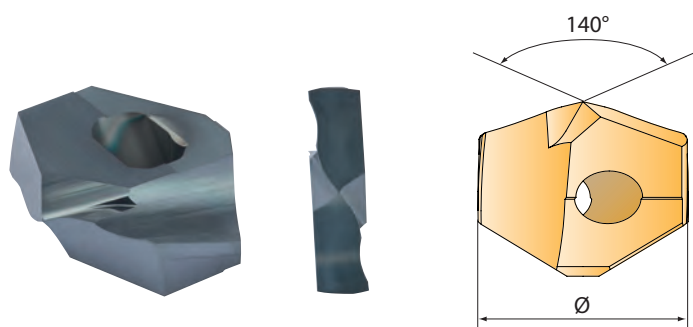

VA Schneideinsätze / Inserts / Inserti

2

Bezeichnung Designation Articolo	Durchmesser			beschichtet coated rivestito
	[mm]	[decimal]	[inch]	AM5040
SDI1400-VA	14,0	0,5512"		●
SDI1429-VA	14,29	0,5626"	9/16	●
SDI1450-VA	14,5	0,5709"		●
SDI1468-VA	14,68	0,5780"	37/64	●
SDI1500-VA	15,0	0,5906"		●
SDI1550-VA	15,5	0,6102"		●
SDI1587-VA	15,87	0,6248"	5/8	●
SDI1600-VA	16,0	0,6299"		●
SDI1627-VA	16,27	0,6406"	41/64	●
SDI1650-VA	16,5	0,6496"		●
SDI1667-VA	16,67	0,6563"	21/32	●
SDI1700-VA	17,0	0,6693"		●
SDI1746-VA	17,46	0,6874"	11/16	●
SDI1750-VA	17,5	0,6890"		●
SDI1786-VA	17,86	0,7031"	45/64	●
SDI1800-VA	18,0	0,7087"		●
SDI1826-VA	18,26	0,7189"	23/32	●
SDI1850-VA	18,5	0,7283"		●
SDI1865-VA	18,65	0,7343"	47/64	●
SDI1900-VA	19,0	0,7480"		●
SDI1905-VA	19,05	0,7500"	3/4	●
SDI1920-VA	19,2	0,7559"		●
SDI1950-VA	19,5	0,7677"		●
SDI2000-VA	20,0	0,7874"		●
SDI2050-VA	20,5	0,8071"		●
SDI2064-VA	20,64	0,8126"	13/16	●
SDI2100-VA	21,0	0,8268"		●
SDI2143-VA	21,43	0,8437"	27/32	●
SDI2150-VA	21,5	0,8465"		●
SDI2200-VA	22,0	0,8661"		●
SDI2223-VA	22,23	0,8752"	7/8	●
SDI2250-VA	22,5	0,8858"		●
SDI2300-VA	23,0	0,9055"		●
SDI2342-VA	23,42	0,9220"	59/64	●
SDI2350-VA	23,5	0,9252"		●
SDI2381-VA	23,81	0,9374"	15/16	●
SDI2400-VA	24,0	0,9449"		●
SDI2450-VA	24,5	0,9646"		●

VA Schneideinsätze / Inserts / Inserti

Bezeichnung Designation Articolo	[mm]	Durchmesser		beschichtet coated rivestito
		[decimal]	[inch]	AM5040
SDI2461-VA	24,61	0,9689"	$\frac{31}{32}$	●
SDI2500-VA	25,0	0,9843"	$\frac{63}{64}$	●
SDI2540-VA	25,4	1,0000"	1	●
SDI2550-VA	25,5	1,0039"		●
SDI2580-VA	25,8	1,0157"	$1 \frac{1}{64}$	●
SDI2600-VA	26,0	1,0236"		●
SDI2619-VA	26,19	1,0311"	$1 \frac{1}{32}$	●
SDI2650-VA	26,5	1,0433"		●
SDI2700-VA	27,0	1,0630"	$1 \frac{1}{16}$	●
SDI2750-VA	27,5	1,0827"		●
SDI2800-VA	28,0	1,1024"		●
SDI2850-VA	28,5	1,1220"		●
SDI2858-VA	28,58	1,1252"	$1 \frac{1}{8}$	●
SDI2900-VA	29,0	1,1417"		●
SDI2937-VA	29,37	1,1563"	$1 \frac{5}{32}$	●
SDI2950-VA	29,5	1,1614"		●
SDI3000-VA	30,0	1,1811"		●
SDI3016-VA	30,16	1,1874"	$1 \frac{3}{16}$	●
SDI3050-VA	30,5	1,2008"		●
SDI3100-VA	31,0	1,2205"		●
SDI3150-VA	31,5	1,2402"		●
SDI3175-VA	31,75	1,2500"	$1 \frac{1}{4}$	●
SDI3200-VA	32,0	1,2598"		●

Schrauben und Schraubendreher / Screws and Screwdrivers / Chiavi e Viti

Torx®-Plus Schraube Torx®-Plus screw Viti di serraggio Torx®-Plus	Drehmoment Torque Momento torcente	Durchmesserbereich Dia-range Campo Diametri	Gewindegröße Thread size Misura filetti	Torx®-Größe Torx® size Dimensione Torx®
SS 1130	1,2 Nm	12–13,99 mm	M2,5	T7
SS 1310	2,0 Nm	14–15,99 mm	M3,0	T8
SS 1510	2,0 Nm	16–17,99 mm	M3,0	T8
SS 1700	4,0 Nm	18–19,99 mm	M4,0	T15
SS 1900	5,0 Nm	20–21,99 mm	M5,0	T20
SS 2090	5,0 Nm	22–23,99 mm	M5,0	T20
SS 2290	5,0 Nm	24–25,99 mm	M5,0	T20
SS 2490	5,5 Nm	26–27,99 mm	M6,0	T25
SS 2690	5,5 Nm	28–29,99 mm	M6,0	T25
SS 2690	5,5 Nm	30–32,99 mm	M6,0	T25

Hinweis: Drehmoment-Schraubendreher siehe Seite 281.

Remark: For torque screwdrivers see page 281.

Nota: Chiavi dinamometriche a pagina 281.



ISO	Werkstoff	Zugfestigkeit	Schnittgeschwindigkeit	Ø-Bereich	Ø-Bereich	Ø-Bereich	Ø-Bereich	Ø-Bereich
		[N/mm ²]	[m/min]	12-15 mm [mm/U]	15-18 mm [mm/U]	18-22 mm [mm/U]	22-27 mm [mm/U]	27-32 mm [mm/U]
P	Automatenstähle z. B. 9SMn28; 9SMnPb28; 10SPb20	bis 500	125	0,15 - 0,29	0,21 - 0,36	0,28 - 0,42	0,35 - 0,53	0,37 - 0,56
		500 - 850	105	0,13 - 0,25	0,21 - 0,36	0,28 - 0,42	0,35 - 0,53	0,37 - 0,56
	Baustähle z. B. St33; St37-2; St44-2; St52; St60	350 - 500	95	0,13 - 0,25	0,21 - 0,36	0,26 - 0,39	0,30 - 0,45	0,32 - 0,48
		500 - 850	75	0,11 - 0,21	0,20 - 0,34	0,21 - 0,32	0,26 - 0,39	0,29 - 0,44
	Unlegierte und niedrig legierter Stahl beinhaltet auch Vergütungsstähle und Einsatzstähle z. B. C15; C22; 20Mn5; Ck45	850 - 1200	70	0,09 - 0,17	0,17 - 0,29	0,20 - 0,30	0,22 - 0,33	0,26 - 0,39
		bis 450	120	0,13 - 0,25	0,20 - 0,34	0,26 - 0,39	0,32 - 0,48	0,34 - 0,51
		450 - 750	95	0,11 - 0,21	0,17 - 0,29	0,21 - 0,32	0,31 - 0,47	0,33 - 0,50
		750 - 900	85	0,11 - 0,21	0,17 - 0,29	0,21 - 0,32	0,31 - 0,47	0,33 - 0,50
	Legierter Stahl z. B. 42CrMo4; 16MnCr5; 36CrNiMo4 14NiCrMo13-4; Ck75; Ck101; 17CrNiMo8; 35CrMo4; 41Cr4; 50MnSi4	900 - 1100	70	0,09 - 0,17	0,15 - 0,26	0,20 - 0,30	0,26 - 0,39	0,29 - 0,44
		bis 600	100	0,13 - 0,25	0,17 - 0,29	0,21 - 0,32	0,31 - 0,47	0,34 - 0,51
		600 - 800	90	0,11 - 0,21	0,17 - 0,29	0,21 - 0,32	0,31 - 0,47	0,34 - 0,51
		800 - 950	85	0,11 - 0,21	0,15 - 0,26	0,21 - 0,32	0,31 - 0,47	0,34 - 0,51
950 - 110		75	0,09 - 0,17	0,13 - 0,22	0,20 - 0,30	0,26 - 0,39	0,29 - 0,44	
Hochlegierter und hochfester Stahl z. B. 41CrAlMo7; 36CrNiMo4; 32NiCrMo14-5	1100 - 1250	65	0,07 - 0,13	0,13 - 0,22	0,20 - 0,30	0,26 - 0,39	0,29 - 0,44	
	600 - 1000	60	0,11 - 0,21	0,15 - 0,26	0,20 - 0,30	0,21 - 0,32	0,24 - 0,36	
	1000 - 1200	55	0,09 - 0,17	0,11 - 0,19	0,20 - 0,30	0,21 - 0,32	0,24 - 0,36	
Werkzeugstähle z. B. C75W; 102Cr6; 105WCr6; X153CrMoV12	1200 - 1350	50	0,07 - 0,13	0,09 - 0,15	0,17 - 0,26	0,20 - 0,30	0,23 - 0,35	
	500 - 700	65	0,09 - 0,17	0,13 - 0,22	0,17 - 0,26	0,21 - 0,32	0,24 - 0,36	
M	Nichtrostender Stahl und Stahlguss	austenitisch und austenitisch/ferritisch, abgeschreckt	450 - 610	65	0,09 - 0,14	0,16 - 0,21	0,19 - 0,24	0,24 - 0,26
		610 - 930	50	0,09 - 0,14	0,14 - 0,18	0,16 - 0,20	0,20 - 0,22	0,23 - 0,25
K	Grauguss z. B. GG25; GG40	perlitisch, ferritisch	500 - 700	125	0,14 - 0,27	0,20 - 0,38	0,26 - 0,42	0,37 - 0,52
		perlitisch, martensitisch	700 - 850	95	0,10 - 0,19	0,16 - 0,30	0,19 - 0,30	0,26 - 0,36
		850 - 1100	85	0,10 - 0,19	0,14 - 0,27	0,16 - 0,26	0,22 - 0,31	0,25 - 0,35
K	Gusseisen mit Kugelgraphit z. B. GGG50	ferritisch	540	120	0,12 - 0,23	0,17 - 0,32	0,20 - 0,32	0,29 - 0,41
		perlitisch	850	95	0,10 - 0,19	0,14 - 0,27	0,18 - 0,29	0,26 - 0,36
K	Temperguss z. B. GTS70	ferritisch	450	125	0,12 - 0,23	0,17 - 0,32	0,20 - 0,32	0,29 - 0,41
		perlitisch	780	97	0,10 - 0,19	0,14 - 0,27	0,18 - 0,29	0,26 - 0,36
N	Aluminium-Knetlegierungen z. B. AlMgSiPb; AlCuMg1; AlMgSi1	nicht aushärtbar	200	450	0,10 - 0,19	0,17 - 0,27	0,27 - 0,35	0,33 - 0,40
		aushärtbar, ausgehärtet	335	305	0,12 - 0,23	0,29 - 0,46	0,37 - 0,48	0,52 - 0,62
	Aluminium-Gusslegierungen z. B. G-ALSi10Mg; G-ALSi12	≤ 12 % Si, ausgehärtet	250	450	0,20 - 0,38	0,31 - 0,50	0,40 - 0,52	0,48 - 0,58
		≤ 12 % Si, aushärtbar, ausgehärtet	300	380	0,20 - 0,38	0,30 - 0,48	0,40 - 0,52	0,48 - 0,58
		≤ 12 % Si, nicht aushärtbar	450	280	0,18 - 0,34	0,28 - 0,45	0,36 - 0,47	0,46 - 0,55
N	Kupfer und Kupferlegierungen (Bronze / Messing)	Automatenlegierung, Pb > 1 %	370	145	0,15 - 0,29	0,23 - 0,37	0,28 - 0,36	0,38 - 0,46
		Messing, Rotguss	300	185	0,16 - 0,30	0,24 - 0,38	0,29 - 0,38	0,39 - 0,47
		Aluminiumbronze	500	110	0,14 - 0,27	0,20 - 0,32	0,26 - 0,34	0,37 - 0,44
		Kupfer und Elektrolytkupfer	200	120	0,05 - 0,10	0,09 - 0,14	0,10 - 0,13	0,16 - 0,19
N	Nichtmetallische Werkstoffe	Duroplaste	Die Schnittwerte sind abhängig von der vorhandenen Kühlung. Startwerte wie bei Aluminium-Knetlegierungen (Luftkühlung ist empfohlen).					
		Faserverstärkte Kunststoffe						
		Hartgummi						
S	Warmfeste Legierungen / Superlegierungen z. B. Inconell, Hasteloy, Nimonic, Waspaloy, Monel	Fe-Basis gegläht	700	32	0,08 - 0,12	0,10 - 0,13	0,12 - 0,15	0,14 - 0,17
		Fe-Basis ausgehärtet	980	-	-	-	-	-
		Ni- oder Co-Basis gegläht	850	32	0,08 - 0,10	0,09 - 0,12	0,11 - 0,14	0,12 - 0,15
		Ni- oder Co-Basis gegossen ausgehärtet	1100	-	-	-	-	-
		1230	25	0,06 - 0,08	0,07 - 0,10	0,09 - 0,12	0,11 - 0,14	0,11 - 0,16
S	Titanlegierungen z. B. Ti99,5; Ti Al6V4; TiCu2	Reintitan	500 - 700	39	0,09 - 0,17	0,16 - 0,26	0,19 - 0,25	0,24 - 0,29
		700 - 1050	34	0,09 - 0,17	0,14 - 0,22	0,16 - 0,21	0,22 - 0,26	
H	Gehärteter Stahl	gehärtet und angelassen	1020 - 1365	44	0,09 - 0,17	0,14 - 0,22	0,22 - 0,29	0,25 - 0,30
		gehärtet und angelassen	1365 - 1850	26	0,06 - 0,11	0,11 - 0,18	0,16 - 0,21	0,22 - 0,26
	Hartguss	gegossen	1365	35	0,07 - 0,13	0,12 - 0,19	0,18 - 0,23	0,22 - 0,26
H	Gehärtetes Gusseisen	gehärtet und angelassen	2090	-	-	-	-	

Die Tabellenwerte sind Richtwerte. Es kann notwendig sein, die Werte den jeweiligen Bearbeitungsbedingungen anzupassen.

2

ISO	Material	Tensile strength	Cutting speed	Dia-range 12-15 mm	Dia-range 15-18 mm	Dia-range 18-22 mm	Dia-range 22-27 mm	Dia-range 27-32 mm
		[N/mm ²]	[m/min]	[mm/U]	[mm/U]	[mm/U]	[mm/U]	[mm/U]
P	Unalloyed steel and cast steel e. G. 9SMn28; 9SMnPb28; 10SPb20	up to 500	125	0,15 - 0,29	0,21 - 0,36	0,28 - 0,42	0,35 - 0,53	0,37 - 0,56
		500 - 850	105	0,13 - 0,25	0,21 - 0,36	0,28 - 0,42	0,35 - 0,53	0,37 - 0,56
	Structural steel e. G. St33; St37-2; St44-2; St52; St60	350 - 500	95	0,13 - 0,25	0,21 - 0,36	0,26 - 0,39	0,30 - 0,45	0,32 - 0,48
		500 - 850	75	0,11 - 0,21	0,20 - 0,34	0,21 - 0,32	0,26 - 0,39	0,29 - 0,44
	None- and low alloy steel as well as carbon steel and case hardened steel e. G. C15; C22; 20Mn5; Ck45	850 - 1200	70	0,09 - 0,17	0,17 - 0,29	0,20 - 0,30	0,22 - 0,33	0,26 - 0,39
		bis 450	120	0,13 - 0,25	0,20 - 0,34	0,26 - 0,39	0,32 - 0,48	0,34 - 0,51
		450 - 750	95	0,11 - 0,21	0,17 - 0,29	0,21 - 0,32	0,31 - 0,47	0,33 - 0,50
		750 - 900	85	0,11 - 0,21	0,17 - 0,29	0,21 - 0,32	0,31 - 0,47	0,33 - 0,50
		900 - 1100	70	0,09 - 0,17	0,15 - 0,26	0,20 - 0,30	0,26 - 0,39	0,29 - 0,44
	Alloys steel e. G. 42CrMo4; 16MnCr5; 36CrNiMo4 14NiCrMo13-4; Ck75; Ck101; 17CrNiMo8; 35CrMo4; 41Cr4; 50MnSi4	bis 600	100	0,13 - 0,25	0,17 - 0,29	0,21 - 0,32	0,31 - 0,47	0,34 - 0,51
		600 - 800	90	0,11 - 0,21	0,17 - 0,29	0,21 - 0,32	0,31 - 0,47	0,34 - 0,51
		800 - 950	85	0,11 - 0,21	0,15 - 0,26	0,21 - 0,32	0,31 - 0,47	0,34 - 0,51
		950 - 110	75	0,09 - 0,17	0,13 - 0,22	0,20 - 0,30	0,26 - 0,39	0,29 - 0,44
		1100 - 1250	65	0,07 - 0,13	0,13 - 0,22	0,20 - 0,30	0,26 - 0,39	0,29 - 0,44
High alloys steel e. G. 41CrAlMo7; 36CrNiMo4; 32NiCrMo14-5	600 - 1000	60	0,11 - 0,21	0,15 - 0,26	0,20 - 0,30	0,21 - 0,32	0,24 - 0,36	
	1000 - 1200	55	0,09 - 0,17	0,11 - 0,19	0,20 - 0,30	0,21 - 0,32	0,24 - 0,36	
	1200 - 1350	50	0,07 - 0,13	0,09 - 0,15	0,17 - 0,26	0,20 - 0,30	0,23 - 0,35	
Tool steel e. G. C75W; 102Cr6; 105WCr6; X153CrMoV12	500 - 700	65	0,09 - 0,17	0,13 - 0,22	0,17 - 0,26	0,21 - 0,32	0,24 - 0,36	
	700 - 950	50	0,09 - 0,17	0,13 - 0,22	0,17 - 0,26	0,21 - 0,32	0,24 - 0,36	
M	Stainless steel and cast steel	austenitic and austenitic/ferritic	450 - 610	65	0,09 - 0,14	0,16 - 0,21	0,19 - 0,24	0,24 - 0,26
		chilled	610 - 930	50	0,09 - 0,14	0,14 - 0,18	0,16 - 0,20	0,20 - 0,22
K	Cast iron e. G. GG25; GG40	pearlitic, ferritic	500 - 700	125	0,14 - 0,27	0,20 - 0,38	0,26 - 0,42	0,37 - 0,52
		pearlitic, martensitic	700 - 850	95	0,10 - 0,19	0,16 - 0,30	0,19 - 0,30	0,26 - 0,36
			850 - 1100	85	0,10 - 0,19	0,14 - 0,27	0,16 - 0,26	0,22 - 0,31
	Cast iron with nodular graphite e. G. GGG50	ferritic	540	120	0,12 - 0,23	0,17 - 0,32	0,20 - 0,32	0,29 - 0,41
pearlitic		850	95	0,10 - 0,19	0,14 - 0,27	0,18 - 0,29	0,26 - 0,36	
	Malleable cast iron e. G. GTS70	ferritic	450	125	0,12 - 0,23	0,17 - 0,32	0,20 - 0,32	0,29 - 0,41
		pearlitic	780	97	0,10 - 0,19	0,14 - 0,27	0,18 - 0,29	0,26 - 0,36
N	Aluminium alloys, long chipping e. G. AlMgSiPb; AlCuMg1; AlMgSi1	not heat treatable	200	450	0,10 - 0,19	0,17 - 0,27	0,27 - 0,35	0,33 - 0,40
		heat treatable, heat-treated	335	305	0,12 - 0,23	0,29 - 0,46	0,37 - 0,48	0,52 - 0,62
	Casted aluminium alloys e. G. G-ALSi10Mg; G-ALSi12	≤ 12 % Si, hardened	250	450	0,20 - 0,38	0,31 - 0,50	0,40 - 0,52	0,48 - 0,58
		≤ 12 % Si, heat treatable, hardened	300	380	0,20 - 0,38	0,30 - 0,48	0,40 - 0,52	0,48 - 0,58
		≤ 12 % Si, not heat treatable	450	280	0,18 - 0,34	0,28 - 0,45	0,36 - 0,47	0,46 - 0,55
	Copper and copper alloys (brass / bronze)	Lead alloys, Pb > 1 %	370	145	0,15 - 0,29	0,23 - 0,37	0,28 - 0,36	0,38 - 0,46
Brass, bronze		300	185	0,16 - 0,30	0,24 - 0,38	0,29 - 0,38	0,39 - 0,47	
Aluminium bronze		500	110	0,14 - 0,27	0,20 - 0,32	0,26 - 0,34	0,37 - 0,44	
Copper and electrolyte copper		200	120	0,05 - 0,10	0,09 - 0,14	0,10 - 0,13	0,16 - 0,19	
Non-ferrous materials	Duroplastics	The cutting datas are depending on the available coolant supply. Starting datas are the same as aluminium alloys, long chipping. Air coolant is recommended.						
	Re- inforced plastics							
	Hard rubber							
S	High temperature resistant alloys e. G. Inconell, Hasteloy, Nimonic, Waspaloy, Monel	Fe-alloyed annealed	700	32	0,08 - 0,12	0,10 - 0,13	0,12 - 0,15	0,14 - 0,17
		heat - treated	980	-	-	-	-	-
		Ni- or annealed	850	32	0,08 - 0,10	0,09 - 0,12	0,11 - 0,14	0,12 - 0,15
		Co based casting	1100	-	-	-	-	-
	heat - treated	1230	25	0,06 - 0,08	0,07 - 0,10	0,09 - 0,12	0,11 - 0,14	
Titanium alloys / Titan e. G. Ti99,5; Ti Al6V4; TiCu2	Pure titan	500 - 700	39	0,09 - 0,17	0,16 - 0,26	0,19 - 0,25	0,24 - 0,29	
		700 - 1050	34	0,09 - 0,17	0,14 - 0,22	0,16 - 0,21	0,22 - 0,26	
H	Hardened steel	hardened and tempered	1020 - 1365	44	0,09 - 0,17	0,14 - 0,22	0,22 - 0,29	0,25 - 0,30
		hardened and tempered	1365 - 1850	26	0,06 - 0,11	0,11 - 0,18	0,16 - 0,21	0,22 - 0,26
	Hard cast iron	casting	1365	35	0,07 - 0,13	0,12 - 0,19	0,18 - 0,23	0,22 - 0,26
Hardened cast iron	hardened and tempered	2090	-	-	-	-	-	

The datas given are only approximate values. It can be necessary to adjust these datas to the individual machining operation.

ISO	Materiale	Carico di rottura [N/mm ²]	Velocità di taglio [m/min]	Gamma					
				12-15 mm [mm/U]	15-18 mm [mm/U]	18-22 mm [mm/U]	22-27 mm [mm/U]	27-32 mm [mm/U]	
P	Acciaio non legato o da fusione p. e. 9SMn28; 9SMnPb28; 10SPb20	fino a 500	125	0,15 - 0,29	0,21 - 0,36	0,28 - 0,42	0,35 - 0,53	0,37 - 0,56	
		500 - 850	105	0,13 - 0,25	0,21 - 0,36	0,28 - 0,42	0,35 - 0,53	0,37 - 0,56	
	Acciaio da costruzione p. e. St33; St37-2; St44-2; St52; St60	350 - 500	95	0,13 - 0,25	0,21 - 0,36	0,26 - 0,39	0,30 - 0,45	0,32 - 0,48	
		500 - 850	75	0,11 - 0,21	0,20 - 0,34	0,21 - 0,32	0,26 - 0,39	0,29 - 0,44	
	Acciaio non legato o debolmente legato, acciaio al carbonio o acciaio stampato p. e. C15; C22; 20Mn5; Ck45	bis 450	120	0,13 - 0,25	0,20 - 0,34	0,26 - 0,39	0,32 - 0,48	0,34 - 0,51	
		450 - 750	95	0,11 - 0,21	0,17 - 0,29	0,21 - 0,32	0,31 - 0,47	0,33 - 0,50	
		750 - 900	85	0,11 - 0,21	0,17 - 0,29	0,21 - 0,32	0,31 - 0,47	0,33 - 0,50	
		900 - 1100	70	0,09 - 0,17	0,15 - 0,26	0,20 - 0,30	0,26 - 0,39	0,29 - 0,44	
	Acciaio legato p. e. 42CrMo4; 16MnCr5; 36CrNiMo4 14NiCrMo13-4; Ck75; Ck101; 17CrNiMo8, 35CrMo4; 41Cr4; 50MnSi4	bis 600	100	0,13 - 0,25	0,17 - 0,29	0,21 - 0,32	0,31 - 0,47	0,34 - 0,51	
		600 - 800	90	0,11 - 0,21	0,17 - 0,29	0,21 - 0,32	0,31 - 0,47	0,34 - 0,51	
		800 - 950	85	0,11 - 0,21	0,15 - 0,26	0,21 - 0,32	0,31 - 0,47	0,34 - 0,51	
		950 - 110	75	0,09 - 0,17	0,13 - 0,22	0,20 - 0,30	0,26 - 0,39	0,29 - 0,44	
1100 - 1250		65	0,07 - 0,13	0,13 - 0,22	0,20 - 0,30	0,26 - 0,39	0,29 - 0,44		
Acciaio fortemente legato p. e. 41CrAlMo7; 36CrNiMo4; 32NiCrMo14-5	600 - 1000	60	0,11 - 0,21	0,15 - 0,26	0,20 - 0,30	0,21 - 0,32	0,24 - 0,36		
	1000 - 1200	55	0,09 - 0,17	0,11 - 0,19	0,20 - 0,30	0,21 - 0,32	0,24 - 0,36		
	1200 - 1350	50	0,07 - 0,13	0,09 - 0,15	0,17 - 0,26	0,20 - 0,30	0,23 - 0,35		
Acciaio da utensili p. e. C75W; 102Cr6; 105WCr6; X153CrMoV12	500 - 700	65	0,09 - 0,17	0,13 - 0,22	0,17 - 0,26	0,21 - 0,32	0,24 - 0,36		
	700 - 950	50	0,09 - 0,17	0,13 - 0,22	0,17 - 0,26	0,21 - 0,32	0,24 - 0,36		
M	Acciaio inossidabile ed acciaio da fusione	austenitico e austenitico/ferritico	450 - 610	65	0,09 - 0,14	0,16 - 0,21	0,19 - 0,24	0,24 - 0,26	0,27 - 0,30
		temprato	610 - 930	50	0,09 - 0,14	0,14 - 0,18	0,16 - 0,20	0,20 - 0,22	0,23 - 0,25
K	Ghisa p. e. GG25; GG40	perlitica, ferritica	500 - 700	125	0,14 - 0,27	0,20 - 0,38	0,26 - 0,42	0,37 - 0,52	0,40 - 0,56
		perlitica, martensitica	700 - 850	95	0,10 - 0,19	0,16 - 0,30	0,19 - 0,30	0,26 - 0,36	0,29 - 0,41
			850 - 1100	85	0,10 - 0,19	0,14 - 0,27	0,16 - 0,26	0,22 - 0,31	0,25 - 0,35
	Ghisa grigia sferoidale p. e. GGG50	ferritica	540	120	0,12 - 0,23	0,17 - 0,32	0,20 - 0,32	0,29 - 0,41	0,32 - 0,45
		perlitica	850	95	0,10 - 0,19	0,14 - 0,27	0,18 - 0,29	0,26 - 0,36	0,29 - 0,41
Ghisa malleabile p. e. GTS70	ferritica	450	125	0,12 - 0,23	0,17 - 0,32	0,20 - 0,32	0,29 - 0,41	0,32 - 0,45	
	perlitica	780	97	0,10 - 0,19	0,14 - 0,27	0,18 - 0,29	0,26 - 0,36	0,29 - 0,41	
N	Leghe di Alluminio a truciolo lungo p. e. AlMgSiPb; AlCuMg1; AlMgSi1	non temprabile	200	450	0,10 - 0,19	0,17 - 0,27	0,27 - 0,35	0,33 - 0,40	0,36 - 0,43
		temprabile, temprato	335	305	0,12 - 0,23	0,29 - 0,46	0,37 - 0,48	0,52 - 0,62	0,56 - 0,67
	Leghe di Alluminio da getti p. e. G-ALSi10Mg; G-ALSi12	≤ 12 % Si, temprato	250	450	0,20 - 0,38	0,31 - 0,50	0,40 - 0,52	0,48 - 0,58	0,50 - 0,60
		≤ 12 % Si, temprabile, temprato	300	380	0,20 - 0,38	0,30 - 0,48	0,40 - 0,52	0,48 - 0,58	0,50 - 0,60
		≤ 12 % Si, non temprabile	450	280	0,18 - 0,34	0,28 - 0,45	0,36 - 0,47	0,46 - 0,55	0,48 - 0,58
	Rame e leghe di rame (ottone / bronzo)	Legate al piombo, Pb > 1 %	370	145	0,15 - 0,29	0,23 - 0,37	0,28 - 0,36	0,38 - 0,46	0,41 - 0,49
		Ottone / Bronzo	300	185	0,16 - 0,30	0,24 - 0,38	0,29 - 0,38	0,39 - 0,47	0,42 - 0,50
		Bronzo alluminio	500	110	0,14 - 0,27	0,20 - 0,32	0,26 - 0,34	0,37 - 0,44	0,40 - 0,48
		Rame e rame elettrolitico	200	120	0,05 - 0,10	0,09 - 0,14	0,10 - 0,13	0,16 - 0,19	0,19 - 0,23
	Materiali non ferrosi	Plastiche dure	I parametri di taglio dipendono dalla quantità di refrigerante disponibile. Come parametri di partenza utilizzare dati per leghe di alluminio a truciolo lungo.						
Plastiche rinforzate									
Gomme dure									
S	Leghe esotiche resistenti alle alte temperature p. e. Inconel, Hasteloy, Nimonic, Waspaloy, Monel	Fe-legate ricotto	700	32	0,08 - 0,12	0,10 - 0,13	0,12 - 0,15	0,14 - 0,17	0,14 - 0,18
		temprato	980	-	-	-	-	-	-
		Ni o ricotto	850	32	0,08 - 0,10	0,09 - 0,12	0,11 - 0,14	0,12 - 0,15	0,12 - 0,17
		Co legato stampato	1100	-	-	-	-	-	-
		temprato	1230	25	0,06 - 0,08	0,07 - 0,10	0,09 - 0,12	0,11 - 0,14	0,11 - 0,16
Leghe di titanio, Titanio p. e. Ti99,5; Ti Al6V4; TiCu2	Titanio puro	500 - 700	39	0,09 - 0,17	0,16 - 0,26	0,19 - 0,25	0,24 - 0,29	0,27 - 0,32	
		700 - 1050	34	0,09 - 0,17	0,14 - 0,22	0,16 - 0,21	0,22 - 0,26	0,25 - 0,30	
H	Acciaio temprato	temprato	1020 - 1365	44	0,09 - 0,17	0,14 - 0,22	0,22 - 0,29	0,25 - 0,30	0,28 - 0,34
		temprato	1365 - 1850	26	0,06 - 0,11	0,11 - 0,18	0,16 - 0,21	0,22 - 0,26	0,25 - 0,30
	Ghisa temprata	stampato	1365	35	0,07 - 0,13	0,12 - 0,19	0,18 - 0,23	0,22 - 0,26	0,27 - 0,32
	Ghisa temprata	temprato	2090	-	-	-	-	-	-

I parametri di tagli indicati sono solo indicativi. E' necessario ottimizzarli ad ogni applicazione sulle specifiche condizioni di lavoro.

Neue Anwendung? Noch nie eingesetzt?

- Wählen Sie den kürzest möglichen Halter für die jeweilige Anwendung.
- Auf Seite 139 in diesem Katalog erhalten Sie detaillierte Empfehlungen zu Schnittwerten. Dies sind Standardwerte für den allgemeinen Anwendungsfall. Die Maschinen- und Werkstückstabilität wurden hierbei nicht berücksichtigt.
- Stellen Sie sicher, dass der Halter gut gespannt ist und einen maximalen Rundlauffehler von 0,02 mm – 0,04 mm zum Zentrum hat.
Hierbei bitte auch auf die Montage der Platte achten (siehe Montage der Bohreinsätze auf Seite 144).
- Prüfen Sie, ob der Kühlmitteldruck den Empfehlungen entspricht. Hohe Schnittwerte erfordern einen angepassten Kühlmitteldruck (siehe Seite 143)!
- Beim Anbohren auf einer ebenen Fläche kann mit vollem Vorschub angebohrt werden. Ein verbessertes Zentrierverhalten erreichen Sie, wenn der Vorschub beim Anbohren um 30–50% reduziert wird.
- Bohren Sie nun ca. 1 bis 2xD tief. Die Späne, die nach dem Anschnitt produziert werden, sollten kurz sein (nicht angelaufen oder blau).
- Stoppen Sie und messen Sie die Bohrung auf Toleranzhaltigkeit. Prüfen Sie auch das Zentrierverhalten und die Oberflächengüte.
- Wenn alles korrekt ist, führen Sie den Bohrvorgang weiter durch. Stellen Sie dabei sicher, dass der Bohrprozess stets ruhig und weichschneidend klingt.

New application? Never applied tool?

- Select the shortest possible drill for the application.
- On page 140 of this catalogue leaflet you can get cutting data recommendations. These are standard recommendations in general. Stability of machine and component is not taken into account.
- Please ensure that the holder is securely fastened and its run out is maximum 0.02 – 0.04 mm to centre. Please also check insert assembly (see guidelines page 144).
- Please check that coolant pressure is as recommended. High cutting data needs suitable coolant pressure (see page 143).
- If drilling into a flat surface you can pre-drill using full feed rate. An improved centring is obtained, when pre-drilling, by reducing feed rate by 30–50%.
- Drill 1–2 x D deep. The swarf should be short (not stringy or blue).
- Stop and measure the hole tolerance, check the straightness and surface finish.
- If all is correct, continue drilling. Ensuring that the drilling operation runs smooth and soft cutting.

Primo approccio alla punta? Prima prova?

- Scegliere il corpo punta più corto possibile.
- A pagina 141 di questo catalogo sono indicati i parametri di taglio suggeriti per applicazioni generiche ed in ottimali condizioni di lavoro.
- Assicurarsi che l'inserto sia montato saldamente (vedi pag 144) e correttamente con un run-out massimo di 0,02 – 0,04 mm e che lo stesso valore si ripresenti anche con il corpo punta montato sul mandrino.
- Assicurarsi che la pressione del refrigerante sia sufficiente (vedi pag 143).
- Nel caso di forature in piano l'avanzamento può essere mantenuto costante ed al massimo die valori. In caso di necessità ridurre gli avanzamenti del 30–50% per migliorare il centraggio.
- Come prima fase eseguire fori di prova profondi 1–2xD max e verificare la formazione del truciolo. Esso deve essere il più possibile corto e di colore chiaro. Trucioli lunghi sono difficili da evacuare e trucioli blu indicano eccessivo calore.
- Verificare le tolleranze di esecuzione foro quali diametro, rotondità, linearità e rugosità superficiale.
- In caso di esito positivo proseguire la foratura prestando attenzione che i cicli mantengano un taglio dolce e continuo.

Spanbildung / Swarf formation / Formazione truciolo

Spanbildung in jeder Phase des Bohrprozesses:

- 1.) Lange Spiralspäne stören nicht am Bohrungsprozesses.
- 2.) Diese Art der Spanform sollte locker und unter einem weichschneidendem Geräusch ausgespült werden.
- 3.) Lange Späne, da zum Ende des Bearbeitungsvorganges nur noch die Ecke schneidet.

Swarf shapes in every phase of drilling process:

- 1.) Long spiral swarf does not interfere when pre-drilling.
- 2.) This shape of swarf should easily and with a soft cutting sound be evacuated from the hole.
- 3.) Long swarf, as at the bottom of the hole, only the edges are cutting. Optimize coolant pressure until drilling operation is completed.

Formazione del truciolo nelle diverse fasi di foratura:

- 1.) Truciolo lungo in ingresso non interferisce nella foratura.
- 2.) Truciolo corto per una ottimale evacuazione dal foro.
- 3.) Truciolo lungo a fine foro poichè solo il tagliente periferico lavora. Assicurarsi che l'addizione refrigerante si costante anche in questa fase.

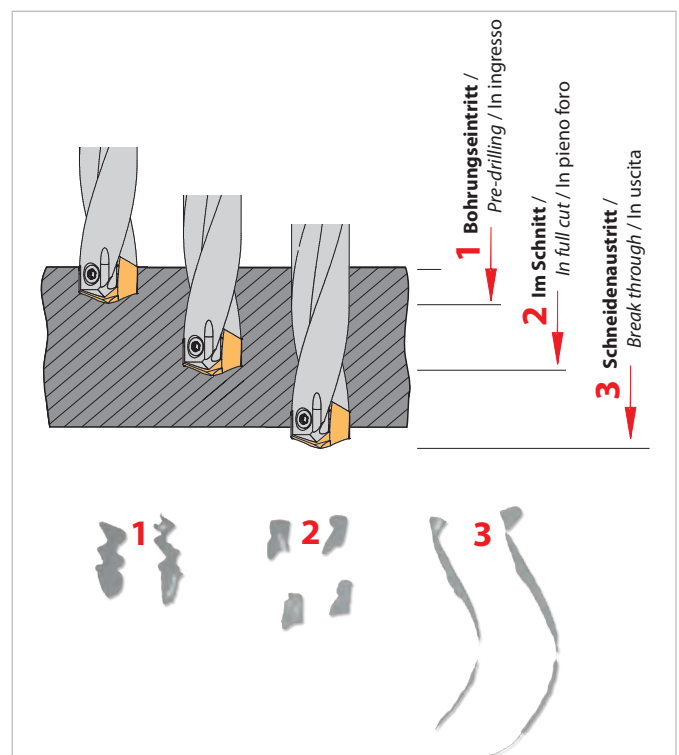

Verschleißformen / Wear pattern / Usura del tagliente

Bevorzugen Sie einen abrasiven Verschleiß an der Schneidenecke für lange und vorhersagbare Standzeiten.

Bei Kolkverschleiß, Aufbauschneidenbildung, plastischer Verformung, Ausbröckelungen etc. sind an den Schnittwerten oder Rahmenbedingungen Änderungen vorzunehmen.

*It is preferred to obtain an even wear on the cutting edge, this ensures long and predictable tool life.
If experiencing a built up edge, deformation, micro chipping etc. we recommend cutting data or set-up changes.*

E'raccomandato impostare la lavorazione in modo da ottenere una usura costante su tutto il filo tagliente.

Questo assicura una corretta previsione di vita inserto per una giusta sostituzione.

Nei casi di tagliente di riporto, deformazione, micro scheggiature, modificare parametri o impostazioni di lavoro.

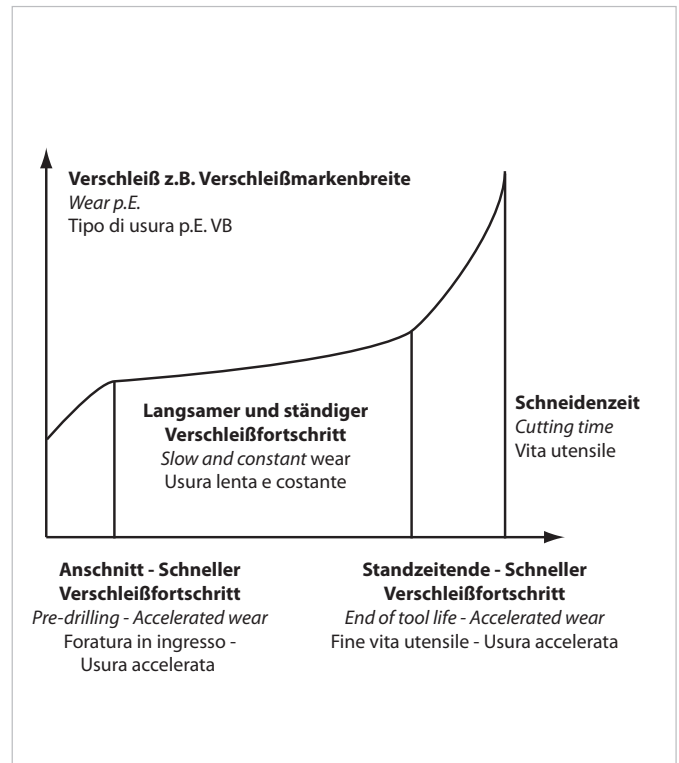

Kühlmittelbedingungen / Coolant conditions / Impostazioni refrigerante

Die Empfehlungen stehen für 3–5xD Bohrtiefe in der allgemeinen Stahlzerspanung.

Für rostfreie Materialien oder hochfeste Stähle empfehlen wir eine Kühlschmierstoff-Konzentration von > = 10%. Materialien wie z.B. Aluminium mit hohem Spanvolumen, erfordern angepasste Werte.

*These recommendations are for 3–5xD in general steel machining.
For stainless steel or high strength steel we recommend coolant lubrication concentration of > = 10%. Materials as aluminium with high swarf volume requires dedicated values.*

Questi parametri sono validi per forature 3xD o 5xD di acciaio generico. Per forature su acciaio inossidabile o acciaio fortemente legato si suggerisce una miscela di refrigerante con olio > = 10%.

Materiali di facile lavorabilità come alluminio prevedono valori specifici dati dall'elevato volume truciolo prodotto.

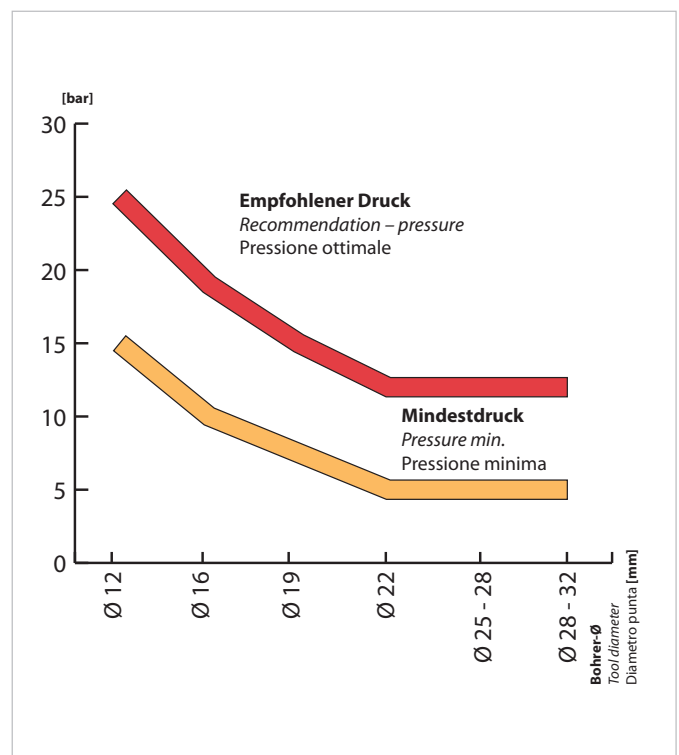

TORX-Plus[®] / TORX-Plus[®] / TORX-Plus[®]

- TORX-Plus[®] Schraube ❶ entfernen
- Bohrplatte ❷ herausnehmen
- Plattensitz bei Bedarf mit Druckluft reinigen
- Neuen Bohreinsatz einsetzen ❸ und gegenhalten, um den korrekten Sitz zu gewährleisten (siehe auch Bild ❸)
- TORX-Plus[®] Schraube einsetzen ❹, weiter den Bohreinsatz fixieren und mit dem erforderlichen Drehmoment anziehen (Drehmomente siehe Tabelle unten)

- Remove TORX-Plus[®] screw ❶
- Take out insert ❷
- If required clean insert seating with high-pressure air
- Insert new drilling insert ❸ hold in place to ensure correct seating (see picture ❸)
- Insert TORX-Plus[®] screw ❹ and lock the insert to the required torx torque (see torque settings below)

- Allentare e rimuovere la vite ❶
- Estrarre l'inserto usurato ❷
- Pulire la sede e togliere eventuali occlusioni
- Inserire il nuovo inserto ❸ spingendolo sul fondo sede (vedi figura ❸)
- Inserire la vite TORX-Plus[®] ❹, e serrare con il giusto momento torcente tenendo sempre premuto l'inserto in sede. Vedere tabelle per il momento torcente suggerito.

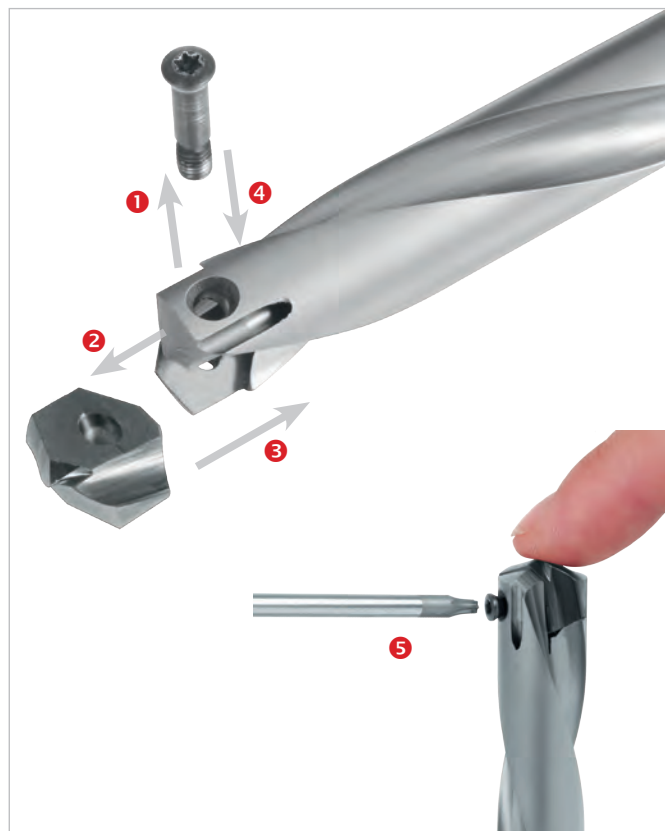

2

Technische Daten – TORX-Plus[®] Schraube

Technical Data – TORX-Plus[®] screw

Dati Tecnici – Viti di serraggio TORX-Plus[®]

Drehmoment Torque Momento torcente	Ø-Bereich Dia-range Campo Diametri	Gewindegröße Thread size Misura filetti	Torx [®] -Größe Torx size Dimensione Torx	ARNO-Bezeichnung ARNO-description ARNO articolo
1,2 Nm	12 – 13,99 mm	M2,5	T7	SS 1130
2,0 Nm	14 – 15,99 mm	M3,0	T8	SS 1310
2,0 Nm	16 – 17,99 mm	M3,0	T8	SS 1510
4,0 Nm	18 – 19,99 mm	M4,0	T15	SS 1700
5,0 Nm	20 – 21,99 mm	M5,0	T20	SS 1900
5,0 Nm	22 – 23,99 mm	M5,0	T20	SS 2090
5,0 Nm	24 – 25,99 mm	M5,0	T20	SS 2290
5,5 Nm	26 – 27,99 mm	M6,0	T25	SS 2490
5,5 Nm	28 – 29,99 mm	M6,0	T25	SS 2690
5,5 Nm	30 – 32,99 mm	M6,0	T25	SS 2690

Hinweis:

Die Schraube bewirkt einen Niederzugseffekt der Bohrplatte. Hierdurch unterliegt sie am Schaft einem erhöhten Verschleiß. Es empfiehlt sich in regelmäßigen Abständen (ca. bei jedem 8. Plattenwechsel) auch die TORX-Plus[®] Schraube zu wechseln.

Remark:

The screw is pushing the insert down into the seat. Because of that the threads of the screw are wearing faster. It is recommended to regularly change (approx every 8th insert index) the TORX-Plus[®] screw.

Nota:

La vite ha diverse funzionalità di bloccaggio inserto, sia assiali che radiali. Questo può generare usure sul corpo vite. E'consigliato sostituire regolarmente la vite TORX-Plus[®] per avere un serraggio sicuro dell'inserto (circa ogni 8 sostituzioni inserto).

Formeln / Formulas / Formule

Bohr-Drehmoment

Drill torque

Momento torcente [Nm]

$$M_c = \frac{K_c \cdot f \cdot d_2}{8000}$$

Das Bohr-Drehmoment ist z. B. wichtig bei größeren Durchmessern und geringeren Drehzahlen. Verschiedene Maschinen erreichen ihr volles Drehmoment erst ab einer definierten Drehzahl.

The drill torque is for example important at larger diameters and lower revolutions. Some machines only achieve their full torque at defined revolutions.

Il momento torcente (coppia) è importante in operazioni di foratura di grande diametro e a basse velocità di taglio. Alcune macchine utensili raggiungono la massima coppia ad un determinato numero di giri.

Schnittleistung

Drilling power

Assorbimento potenza [kW]

$$P_c = \frac{K_c \cdot f \cdot d \cdot V_c}{240000}$$

Die Schnittleistung ist ein Kennwert der wiederum meist aus den Kenndaten der Spindel entnommen werden kann. Oft wird auch von Spindelleistung gesprochen.

The power is a value which in most cases can be obtained from the spindle specifications.

Also referred to as spindle power.

L'assorbimento potenza è importante al fine di paragonare il valore con la potenza mandrino.

Schnittgeschwindigkeit

Cutting Speed

Velocità di taglio [m/min]

$$V_c = \frac{n \cdot \pi \cdot d}{1000}$$

Drehzahl

Revolutions

Velocità di rotazione [U/min]

$$n = \frac{1000 \cdot V_c}{\pi \cdot d}$$

Vorschubgeschwindigkeit

Feed speed

Velocità di avanzamento [mm/min]

$$V_f = n \cdot f$$

Einer der wichtigsten Faktoren beim Bohren, da diese direkt die Zerspanungszeit beeinflusst.

One of the most important factors when drilling as this influences the cutting time.

Uno dei valori più importanti in operazioni di foratura poiché determina il tempo ciclo.

Axiale Vorschubkraft

Axial feed rate power

Assorbimento potenza in spinta [N]

$$F_a = \frac{K \cdot K_c \cdot f \cdot d}{2}$$

Der Beiwert „K“ hängt von der Geometrie der Spitze ab. Bei VHM-Bohrern oder ähnlichen Geometrien kann ein durchschnittlicher Wert von 0,5 angenommen werden. „Kc“ ist die spezifische Schnittkraft (im wesentlichen abhängig vom Material).

The "K" value is depending on the drill point geometry (solid carbide drills and similar geometries can be calculated with an average of 0.5). "Kc" is the specific cutting power (mainly depending on the material).

Il valore "K" dipende dalla forma del tagliente (per punte in metallo duro integrali o simili geometrie corrisponde a 0,5). "Kc" è il coefficiente di taglio, diverso per ogni materiale.

M_c	Drehmoment Torque Coppia (Momento torcente)	[Nm]	P_c	Schnittleistung Cutting rate Assorbimento potenza	[kW]	V_f	Vorschubgeschwindigkeit Feed rate Velocità di avanzamento	[mm/min]
K_c	Spezifische Schnittkraft Chip thickness Coefficiente di taglio	[N/mm ²]	d	Durchmesser Diameter Diametro di foratura	[mm]	F_a	Axiale Vorschubkraft Axial feed rate power Assorbimento potenza in spinta	[N]
f	Vorschub Feed rate Avanzamento	[mm/U]	V_c	Schnittgeschwindigkeit Cutting speed Velocità di taglio	[m/min]	K	Faktor für spezifische Schnittkraft beim Bohren Value for specific cutting force Coefficiente di taglio specifico	
d^2	Durchmesser 2 Diameter 2 Diametro	[mm]	n	Drehzahl Revolution per minute Velocità di rotazione	[U/min]			

Schnell, flexibel und individuell.

Quick, flexible and individual.

Veloce, flessibile e individuale.

- **Wir bieten Ihnen Sonderlösungen für Ihre individuellen Bedürfnisse.**
 - **Bestellen Sie bis 18 Uhr unsere Produkte, erhalten Sie Ihre Lieferung bereits am nächsten Tag.**
 - **Da wir Konstruktion, Produktion und Vertrieb unter einem Dach vereinen, können wir eine hohe Qualität unserer Produkte garantieren.**
 - **Die Mitarbeiter unseres Außendienstes besuchen Sie regelmäßig und unterstützen Sie mit ihrem Produktwissen.**
 - **Unsere Anwendungstechniker beraten Sie direkt vor Ort in Ihrem Werk.**
 - **Die kompetenten ARNO-Ansprechpartner stehen Ihnen bei Fragen und Anliegen gerne zur Verfügung – weltweit.**
- *We offer special solutions for your individual requirement.*
 - *Order your products by 15.30 CET for same day dispatch.*
 - *As we design, manufacture, and service our own products, we offer you only top quality products.*
 - *Our external sales engineers will be visiting regularly.*
 - *Our trained engineers are experienced and will be able to help you with most applications.*
 - *Our competent global ARNO-partners are always available to answer any questions you may have.*
- Offriamo soluzioni speciali per le vostre esigenze.
 - Ordinate i nostri prodotti entro le 15,30 e li avrete il giorno dopo.
 - Possiamo offrirvi la massima qualità avendo produzione, progettazione e vendita in un unico posto.
 - Verete visitati regolarmente dai nostri collaboratori.
 - I nostri tecnici sapranno consigliarvi per il meglio.
 - Tutto il team ARNO è a vostra completa disposizione.

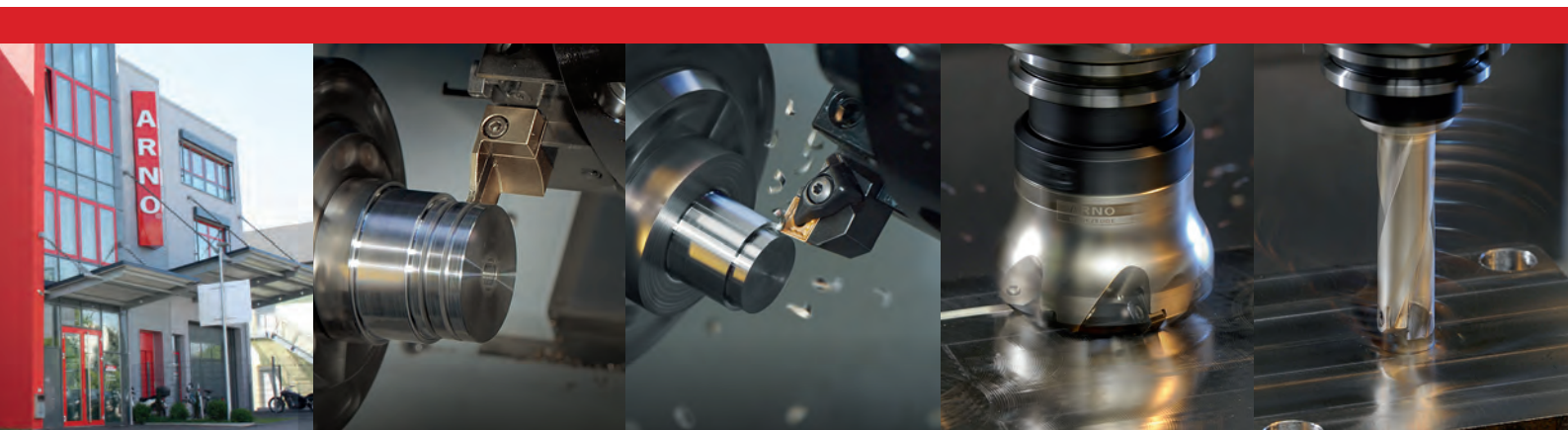

Weitere Informationen finden Sie unter

For more information see

Altre informazioni sotto

www.arno.de

ARNO
Kurzlochbohrer

- Systemvorstellung
- Bezeichnungssystem
- Werkzeugauswahl
- Trägerwerkzeuge
- Wendeschneidplatten
 - Geometriebeschreibung
 - Sortenbeschreibung
- Ersatzteile
- Schnittwerte
- Anwendungshinweise

ARNO
Short-hole drill

- *System introduction*
- *Designation system*
- *Tool shank options*
- *Drill holder*
- *Inserts*
 - *Geometry description*
 - *Grade description*
- *Spare parts*
- *Cutting data*
- *Application reference*

ARNO
Sistema di foratura

- Caratteristiche del sistema **148 – 149**
- Sistema di numerazione **150**
- Tipologie di attacco utensile **151**
- Corpo punta **152 – 155**
- Inserti **156 – 159**
 - Descrizione delle Geometrie **156**
 - Descrizione delle Qualità **157**
- Ricambi **160**
- Parametri di taglio **161 – 163**
- Suggerimenti tecnici **164 – 166**



ARNO Kurzlochbohrer AKB

ARNO Short-hole drill AKB

ARNO Sistema di foratura AKB

Kurzlochbohrer zum Hochleistungsbohren

Short-hole drill for performance drilling

Sistema di foratura per fori corti ad alte prestazioni

3

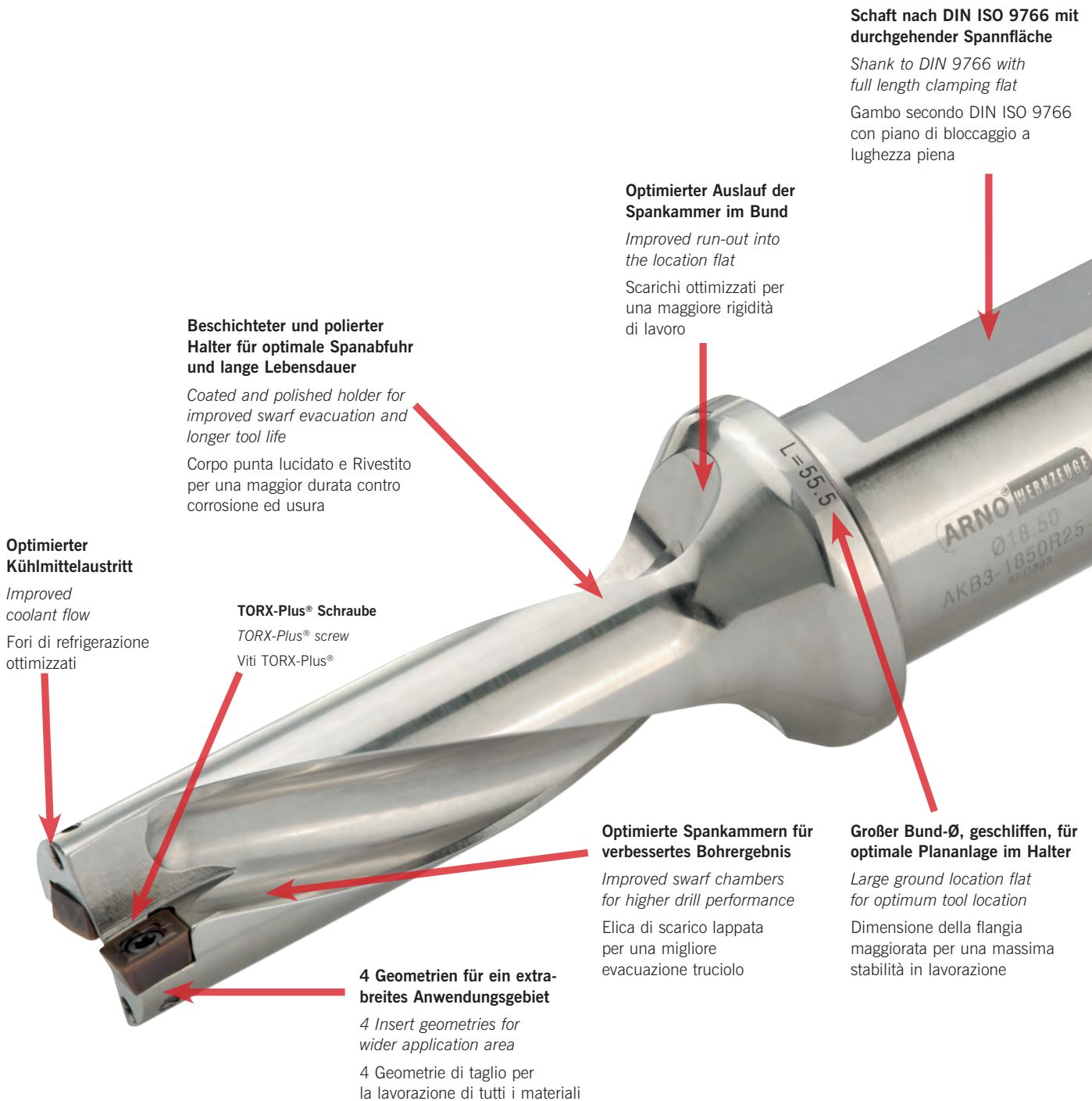

Schaft nach DIN ISO 9766 mit durchgehender Spannfläche

Shank to DIN 9766 with full length clamping flat

Gambo secondo DIN ISO 9766 con piano di bloccaggio a lunghezza piena

Optimierter Auslauf der Spankammer im Bund

Improved run-out into the location flat

Scarichi ottimizzati per una maggiore rigidità di lavoro

Beschichteter und polierter Halter für optimale Spanabfuhr und lange Lebensdauer

Coated and polished holder for improved swarf evacuation and longer tool life

Corpo punta lucidato e rivestito per una maggior durata contro corrosione ed usura

Optimierter Kühlmittelaustritt

Improved coolant flow

Fori di refrigerazione ottimizzati

TORX-Plus® Schraube

TORX-Plus® screw

Viti TORX-Plus®

Optimierte Spankammern für verbessertes Bohrerergebnis

Improved swarf chambers for higher drill performance

Elica di scarico lappata per una migliore evacuazione truciolo

Großer Bund-Ø, geschliffen, für optimale Plananlage im Halter

Large ground location flat for optimum tool location

Dimensione della flangia maggiorata per una massima stabilità in lavorazione

4 Geometrien für ein extra-breites Anwendungsgebiet

4 Insert geometries for wider application area

4 Geometrie di taglio per la lavorazione di tutti i materiali

ARNO®-AKB Vorteile

ARNO®-AKB Advantages

ARNO®-AKB Vantaggi

Leichtes Handling und rationell im Einsatz!

Easy handling and economical in use.

Semplice utilizzo e massima affidabilità.

Innere Kühlmittelzuführung

Through tool coolant

Adduzione interna del refrigerante

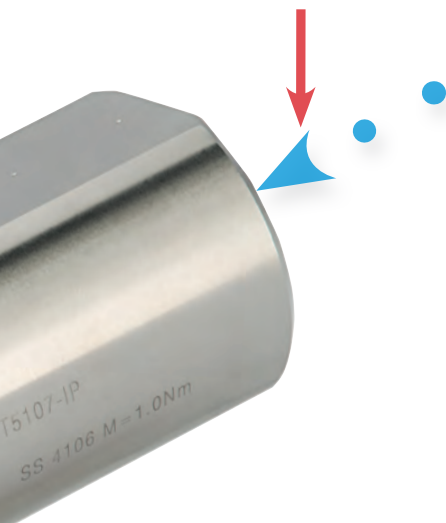

Einfache Identifikation durch umfangreiche Werkzeugbeschriftung:

- **Bezeichnung**
- **Nenn-Ø**
- **Schraubenanzugsmoment**
- **Ersatzteile und Zubehör**

Extensive tooling

identification marking:

- *Ordering code*
- *Diameter*
- *Torque screw recommendation*
- *Spare parts*

Marcatura completa per identificazione di:

- Nr Articolo
- Diametro
- Forza di serraggio raccomandata
- Nr articolo ricambi

Das ARNO®-AKB Bohrsystem bietet dem Anwender noch mehr Möglichkeiten beim Hochleistungsbohren.

- In 2 x D und 3 x D als Standard verfügbar
- Im Durchmesserbereich 14 mm bis 45 mm erhältlich
- Ø 14 mm bis 30 mm, Abstufung 0,5 mm
- Ø 31 mm bis 45 mm, Abstufung 1,0 mm
- Effektiv 4 Schneidkanten einsetzbar
- Wendeschneidplatten in 4 Geometrien und 3 Sorten
- Stabile Schneidkanten und Eckenradien
- Geringe Axialkräfte
- Unempfindliche Zentrumsschneide durch Schneide über der Mitte
- Durch positive Abdrängung keine Rückzugsriefen
- Hohe Prozesssicherheit durch stabile Wendeschneidplatte
- Hohe Wirtschaftlichkeit durch hohe Vorschubwerte
- Auch für Schnittunterbrechungen geeignet
- Ideal für Auskesselungen

With the ARNO® AKB drilling system we offer you even more options for performance drilling.

- *Available in drill depth 2xD and 3xD*
- *Diameter range 14 mm – 45 mm*
- *14 mm – 30 mm available with 0.5 mm increments*
- *31 mm – 45 mm available with 1.0 mm increments*
- *4 edges per insert*
- *Inserts available in 4 geometries and 3 grades*

- *Strong cutting edges and edge radius*
- *Generates low axial cutting forces*
- *Centre cutting*
- *No drill retraction marks*
- *High process security due to very strong inserts*
- *High productivity due to high feed rate potential*
- *Also suitable for cross hole drilling*
- *Ideal for drilling out chambers*

Il sistema di foratura ARNO® AKB offre delle importanti migliorie per forature ad elevate prestazioni.

- Disponibile in lunghezze 2xD e 3xD
- Gamma diametri da 14 mm a 45 mm
- 14 mm–30 mm incremento diametro di 0,5 mm
- 30 mm–45 mm incremento diametro di 1 mm
- Imminente ampliamento gamma su maggiori profondità
- 4 taglienti effettivi per inserto
- Inserti disponibili in 4 Qualità di metallo duro e 3 Geometrie
- Tagliente molto robusto
- Ridotte forze radiali grazie al bilanciamento delle forze di taglio
- Taglio al centro
- Nessun segno sul foro durante l'uscita
- Affidabilità garantita da ottima durata inserti
- Massima produttività grazie ad elevati avanzamenti
- Idonea anche su fori con taglio interrotto
- Ideale per fori passanti

Ausrichtung Wendeschneidplatten / Insert design / Allineamento inserti

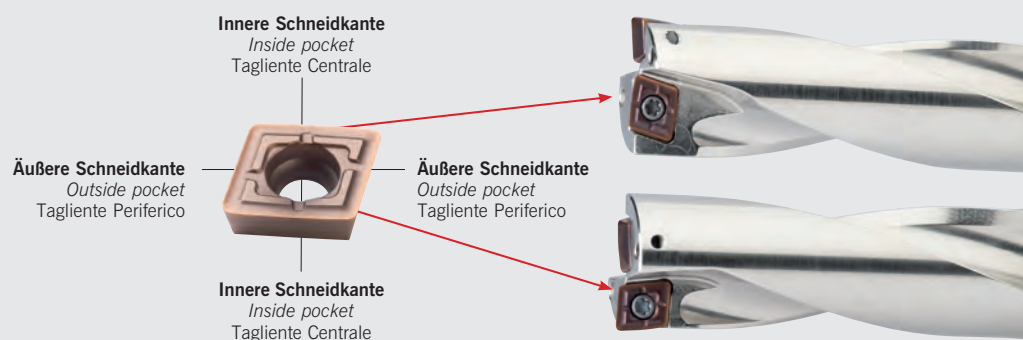

Trägerwerkzeug / Drill holder / Corpo punta

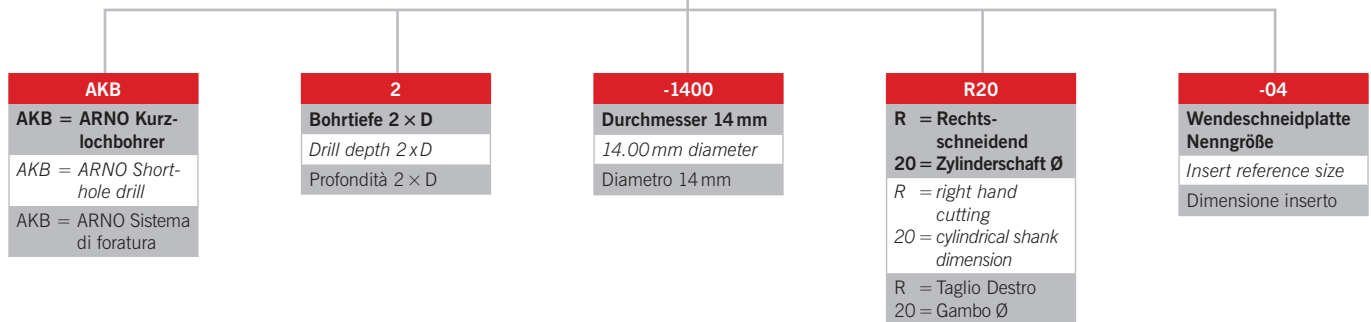

3

Wendeschneidplatten / Indexable inserts / Inserti

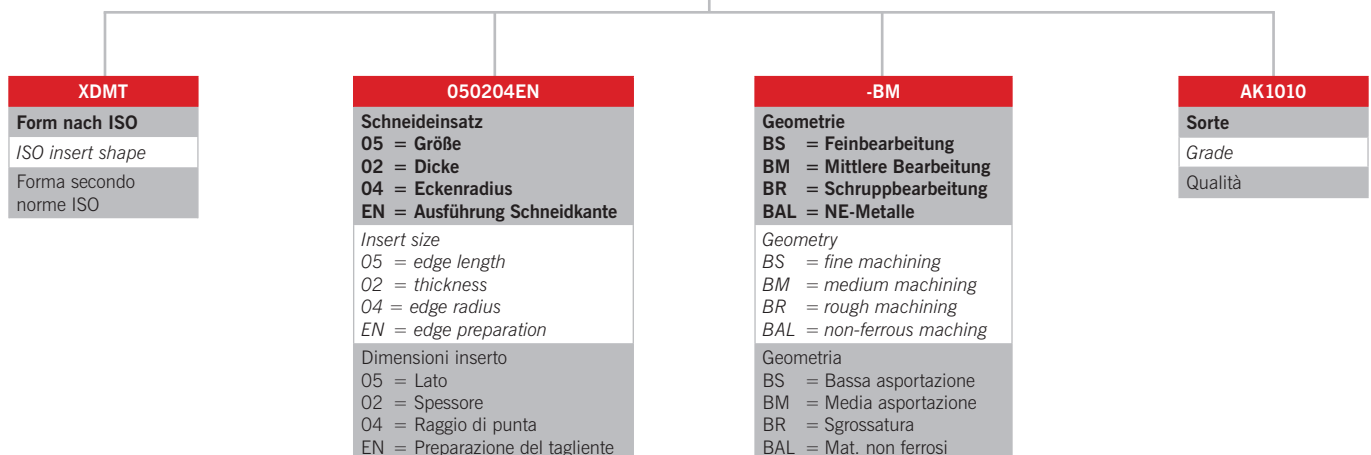



2xD Bohrtiefe / *Drill depth* / Profondità foratura

Ø 14 – 45 mm

152 – 153

3xD Bohrtiefe / *Drill depth* / Profondità foratura

Ø 14 – 45 mm

154 – 155



Wendeschneidplatten / *Indexable inserts* / Inserti

158 – 159

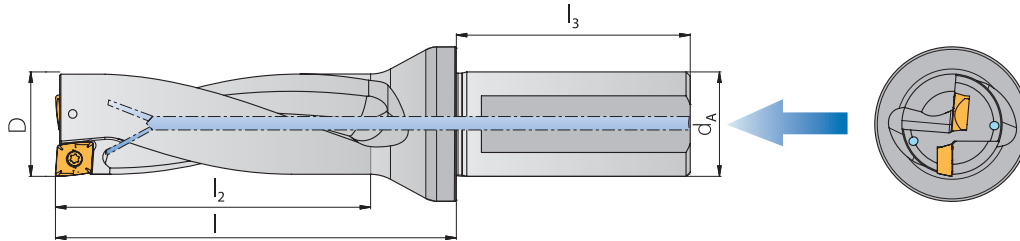
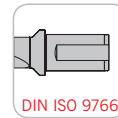

2 × D Trägerwerkzeug / Drill holder / Corpo punta

Bezeichnung Designation Articolo	D	l	l ₂	l ₃	d _A	Wendeschneidplatte Insert Inserto
AKB2-1400R20-04	14,0	46,0	28,0	44	20	XDMT 04...
AKB2-1450R20-04	14,5	47,0	29,0	44	20	XDMT 04...
AKB2-1500R20-04	15,0	48,0	30,0	44	20	XDMT 04...
AKB2-1550R20-05	15,5	46,0	31,0	44	20	XDMT 05...
AKB2-1600R20-05	16,0	50,0	32,0	44	20	XDMT 05...
AKB2-1650R20-05	16,5	51,0	33,0	44	20	XDMT 05...
AKB2-1700R20-05	17,0	52,0	34,0	44	20	XDMT 05...
AKB2-1750R25-05	17,5	53,0	35,0	56	25	XDMT 05...
AKB2-1800R25-05	18,0	54,0	36,0	56	25	XDMT 05...
AKB2-1850R25-06	18,5	55,0	37,0	56	25	XDMT 06...
AKB2-1900R25-06	19,0	56,0	38,0	56	25	XDMT 06...
AKB2-1950R25-06	19,5	57,0	39,0	56	25	XDMT 06...
AKB2-2000R25-06	20,0	58,0	40,0	56	25	XDMT 06...
AKB2-2050R25-06	20,5	59,0	41,0	56	25	XDMT 06...
AKB2-2100R25-06	21,0	60,0	42,0	56	25	XDMT 06...
AKB2-2150R25-06	21,5	61,0	43,0	56	25	XDMT 06...
AKB2-2200R25-06	22,0	62,0	44,0	56	25	XDMT 06...
AKB2-2250R25-06	22,5	63,0	45,0	56	25	XDMT 06...
AKB2-2300R25-07	23,0	67,0	46,0	56	25	XDMT 07...
AKB2-2350R25-07	23,5	68,0	47,0	56	25	XDMT 07...
AKB2-2400R25-07	24,0	69,0	48,0	56	25	XDMT 07...
AKB2-2450R25-07	24,5	70,0	49,0	56	25	XDMT 07...
AKB2-2500R25-07	25,0	71,0	50,0	56	25	XDMT 07...
AKB2-2550R32-07	25,5	74,0	51,0	60	32	XDMT 07...
AKB2-2600R32-07	26,0	75,0	52,0	60	32	XDMT 07...
AKB2-2650R32-07	26,5	76,0	53,0	60	32	XDMT 07...
AKB2-2700R32-07	27,0	77,0	54,0	60	32	XDMT 07...
AKB2-2750R32-07	27,5	78,0	55,0	60	32	XDMT 07...
AKB2-2800R32-07	28,0	79,0	56,0	60	32	XDMT 07...
AKB2-2850R32-07	28,5	80,0	57,0	60	32	XDMT 07...
AKB2-2900R32-09	29,0	83,0	58,0	60	32	XDMT 09...
AKB2-2950R32-09	29,5	84,0	59,0	60	32	XDMT 09...
AKB2-3000R32-09	30,0	88,0	60,0	70	32	XDMT 09...
AKB2-3100R32-09	31,0	90,0	62,0	70	32	XDMT 09...

HINWEIS: Trägerwerkzeuge werden mit 2 Klemmschrauben und Schlüssel geliefert. Bitte beachten Sie unsere Schnittdatenempfehlungen auf Seite 161.

INFORMATION: Holders will be supplied with 2 clamping screws and key. Please note cutting recommendations on page 162.

NOTA: L'utensile é fornito completo di 2 viti e 1 chiave. Per parametri di taglio e informazioni tecniche vedi pagina 163.

2 × D Trägerwerkzeug / Drill holder / Corpo punta

Bezeichnung Designation Articolo	D	I	l ₂	l ₃	d _A	Wendeschneidplatte Insert Inserto
AKB2-3200R32-09	32,0	92,0	64,0	70	32	XDMT 09...
AKB2-3300R32-09	33,0	94,0	66,0	70	32	XDMT 09...
AKB2-3400R32-09	34,0	96,0	68,0	70	32	XDMT 09...
AKB2-3500R32-09	35,0	98,0	70,0	70	32	XDMT 09...
AKB2-3600R32-09	36,0	100,0	72,0	70	32	XDMT 09...
AKB2-3700R32-12	37,0	109,0	74,0	70	32	XDMT 12...
AKB2-3800R32-12	38,0	111,0	76,0	70	32	XDMT 12...
AKB2-3900R32-12	39,0	113,0	78,0	70	32	XDMT 12...
AKB2-4000R32-12	40,0	115,0	80,0	70	32	XDMT 12...
AKB2-4100R32-12	41,0	117,0	82,0	70	32	XDMT 12...
AKB2-4200R32-12	42,0	119,0	84,0	70	32	XDMT 12...
AKB2-4300R32-12	43,0	121,0	86,0	70	32	XDMT 12...
AKB2-4400R32-12	44,0	123,0	88,0	70	32	XDMT 12...
AKB2-4500R32-12	45,0	125,0	90,0	70	32	XDMT 12...

HINWEIS: Trägerwerkzeuge werden mit 2 Klemmschrauben und Schlüssel geliefert.
Bitte beachten Sie unsere Schnittdatenempfehlungen auf Seite 161.

INFORMATION: Holders will be supplied with 2 clamping screws and key.
Please note cutting recommendations on page 162.

NOTA: L'utensile é fornito completo di 2 viti e 1 chiave.
Per parametri di taglio e informazioni tecniche vedi pagina 163.

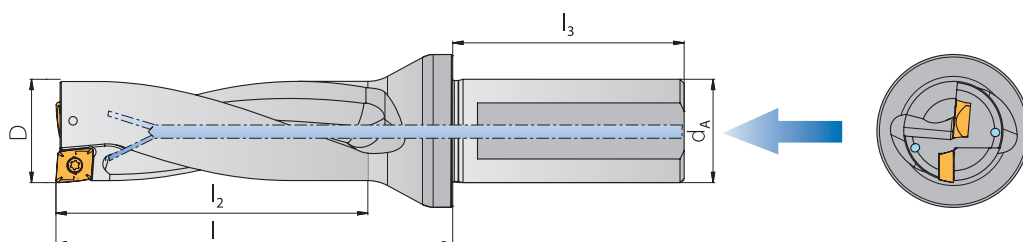

3 × D Trägerwerkzeug / Drill holder / Corpo punta

Bezeichnung Designation Articolo	D	l	l ₂	l ₃	d _A	Wendeschneidplatte Insert Inserto
AKB3-1400R20-04	14,0	60,0	42,0	44	20	XDMT 04...
AKB3-1450R20-04	14,5	61,5	43,5	44	20	XDMT 04...
AKB3-1500R20-04	15,0	63,0	45,0	44	20	XDMT 04...
AKB3-1550R20-05	15,5	64,5	46,5	44	20	XDMT 05...
AKB3-1600R20-05	16,0	66,0	48,0	44	20	XDMT 05...
AKB3-1650R20-05	16,5	67,5	49,5	44	20	XDMT 05...
AKB3-1700R20-05	17,0	69,0	51,0	44	20	XDMT 05...
AKB3-1750R25-05	17,5	70,5	52,5	56	25	XDMT 05...
AKB3-1800R25-05	18,0	72,0	54,0	56	25	XDMT 05...
AKB3-1850R25-06	18,5	73,5	55,5	56	25	XDMT 06...
AKB3-1900R25-06	19,0	75,0	57,0	56	25	XDMT 06...
AKB3-1950R25-06	19,5	76,5	58,5	56	25	XDMT 06...
AKB3-2000R25-06	20,0	78,0	60,0	56	25	XDMT 06...
AKB3-2050R25-06	20,5	79,5	61,5	56	25	XDMT 06...
AKB3-2100R25-06	21,0	81,0	63,0	56	25	XDMT 06...
AKB3-2150R25-06	21,5	82,5	64,5	56	25	XDMT 06...
AKB3-2200R25-06	22,0	84,0	66,0	56	25	XDMT 06...
AKB3-2250R25-06	22,5	85,5	67,5	56	25	XDMT 06...
AKB3-2300R25-07	23,0	90,0	69,0	56	25	XDMT 07...
AKB3-2350R25-07	23,5	91,5	70,5	56	25	XDMT 07...
AKB3-2400R25-07	24,0	93,0	72,0	56	25	XDMT 07...
AKB3-2450R25-07	24,5	94,5	73,5	56	25	XDMT 07...
AKB3-2500R25-07	25,0	96,0	75,0	56	25	XDMT 07...
AKB3-2550R32-07	25,5	99,5	76,5	60	32	XDMT 07...
AKB3-2600R32-07	26,0	101,0	78,0	60	32	XDMT 07...
AKB3-2650R32-07	26,5	102,5	79,5	60	32	XDMT 07...
AKB3-2700R32-07	27,0	104,0	81,0	60	32	XDMT 07...
AKB3-2750R32-07	27,5	105,5	82,5	60	32	XDMT 07...
AKB3-2800R32-07	28,0	107,0	84,0	60	32	XDMT 07...
AKB3-2850R32-07	28,5	108,5	85,5	60	32	XDMT 07...
AKB3-2900R32-09	29,0	112,0	87,0	60	32	XDMT 09...
AKB3-2950R32-09	29,5	113,5	88,5	60	32	XDMT 09...
AKB3-3000R32-09	30,0	118,0	90,0	70	32	XDMT 09...
AKB3-3000R40-09	30,0	118,0	90,0	70	40	XDMT 09...
AKB3-3100R32-09	31,0	121,0	93,0	70	32	XDMT 09...
AKB3-3100R40-09	31,0	121,0	93,0	70	40	XDMT 09...
AKB3-3200R32-09	32,0	124,0	96,0	70	32	XDMT 09...
AKB3-3200R40-09	32,0	124,0	96,0	70	40	XDMT 09...
AKB3-3300R32-09	33,0	127,0	99,0	70	32	XDMT 09...

HINWEIS: Trägerwerkzeuge werden mit 2 Klemmschrauben und Schlüssel geliefert. Bitte beachten Sie unsere Schnittdatenempfehlungen auf Seite 161.

INFORMATION: Holders will be supplied with 2 clamping screws and key. Please note cutting recommendations on page 162.

NOTA: L'utensile é fornito completo di 2 viti e 1 chiave. Per parametri di taglio e informazioni tecniche vedi pagina 163.

3 × D Trägerwerkzeug / Drill holder / Corpo punta

Bezeichnung Designation Articolo	D	I	l ₂	l ₃	d _A	Wendeschneidplatte Insert Inserto
AKB3-3300R40-09	33,0	127,0	99,0	70	40	XDMT 09...
AKB3-3400R32-09	34,0	130,0	102,0	70	32	XDMT 09...
AKB3-3400R40-09	34,0	130,0	102,0	70	40	XDMT 09...
AKB3-3500R32-09	35,0	133,0	105,0	70	32	XDMT 09...
AKB3-3500R40-09	35,0	133,0	105,0	70	40	XDMT 09...
AKB3-3600R32-09	36,0	136,0	108,0	70	32	XDMT 09...
AKB3-3600R40-09	36,0	136,0	108,0	70	40	XDMT 09...
AKB3-3700R32-12	37,0	146,0	111,0	70	32	XDMT 12...
AKB3-3700R40-12	37,0	146,0	111,0	70	40	XDMT 12...
AKB3-3800R32-12	38,0	149,0	114,0	70	32	XDMT 12...
AKB3-3800R40-12	38,0	149,0	114,0	70	40	XDMT 12...
AKB3-3900R32-12	39,0	152,0	117,0	70	32	XDMT 12...
AKB3-3900R40-12	39,0	152,0	117,0	70	40	XDMT 12...
AKB3-4000R32-12	40,0	155,0	120,0	70	32	XDMT 12...
AKB3-4000R40-12	40,0	155,0	120,0	70	40	XDMT 12...
AKB3-4100R32-12	41,0	158,0	123,0	70	32	XDMT 12...
AKB3-4100R40-12	41,0	158,0	123,0	70	40	XDMT 12...
AKB3-4200R32-12	42,0	161,0	126,0	70	32	XDMT 12...
AKB3-4200R40-12	42,0	161,0	126,0	70	40	XDMT 12...
AKB3-4300R32-12	43,0	164,0	129,0	70	32	XDMT 12...
AKB3-4300R40-12	43,0	164,0	129,0	70	40	XDMT 12...
AKB3-4400R32-12	44,0	167,0	132,0	70	32	XDMT 12...
AKB3-4400R40-12	44,0	167,0	132,0	70	40	XDMT 12...
AKB3-4500R32-12	45,0	170,0	135,0	70	32	XDMT 12...
AKB3-4500R40-12	45,0	170,0	135,0	70	40	XDMT 12...

HINWEIS: Trägerwerkzeuge werden mit 2 Klemmschrauben und Schlüssel geliefert.
Bitte beachten Sie unsere Schnittdatenempfehlungen auf Seite 161.

INFORMATION: Holders will be supplied with 2 clamping screws and key.
Please note cutting recommendations on page 162.

NOTA: L'utensile é fornito completo di 2 viti e 1 chiave.
Per parametri di taglio e informazioni tecniche vedi pagina 163.

-BS Geringe Vorschübe/ Spankontrolle

- Ausgezeichnete Spankontrolle bei geringen Vorschüben
- Exzellente Bohrungsqualität
- Gute Oberflächengüte



-BS *Low feed rates/swarf control*

- *Good swarf control at low feed rate*
- *Excellent hole quality*
- *High surface finish*

-BS Geometria per bassi/avanzamenti

- Eccellente controllo truciolo a bassi avanzamenti
- Eccellente qualità del foro
- Buona finitura superficiale

-BM Allgemeine Anwendung

- Geometrie zur allgemeinen Anwendung
- Ausgezeichnete Spankontrolle
- Geringe Schnittkräfte bei geringen bis mittleren Vorschüben



-BM *Universal application*

- *General purpose geometry*
- *Good swarf control*
- *Generates low cutting forces and low to medium feed rates*

-BM Geometria per le Medie asportazioni

- Geometria di applicazione generale, prima scelta per acciai e acciai inossidabili
- Eccellente controllo truciolo
- Basse forze di taglio con avanzamenti medio-bassi

-BR Robuste Schneidkante für höhere Vorschübe

- Verstärkte Schneidkante für hohe Vorschübe
- Kaum Neigung zu Vibrationen
- Reduzierte Geräuschbildung



-BR *Strong cutting edge for higher feed rates*

- *Strengthened cutting edges for high feed rates*
- *Absorbs vibrations well*
- *Reduced noise*

-BR Geometria per massime prestazioni

- Tagliente molto robusto per avanzamenti elevati dove è richiesta massima prestazione
- Bassa tendenza a vibrazioni
- Rumorosità ridotta

-BAL Bearbeitung von Aluminium und NE-Metallen

- Gute Spankontrolle
- Geringe Neigung zur Aufbauschneidenbildung



-BAL *For drilling aluminium*

- *Good swarf control*
- *High resistance to build up edge*

-BAL Geometria per Alluminio e materiali non ferrosi

- Ottimo controllo truciolo
- Tagliente molto vivo

Hartmetall beschichtet / Carbide grade coated / Metallo duro rivestito**AP5030****PVD-Mehrlagenbeschichtung**

Eine universell einsetzbare Sorte im Bereich P30–P35. Hauptanwendungsbereich für die Stahlbearbeitung und rostfreie Stähle. Zähes und unempfindliches Basissubstrat. Für unterbrochene Schnitte geeignet.

PVD-Multilayer coating

A tougher universal grade in the P30–P35 ISO area. Main application area is steel drilling but also suitable for stainless steel. Can also be used for interrupted cutting

PVD-Rivestimento multistrato

Qualità universale utilizzabile nella scala ISO P30–P35. Prima scelta per la lavorazione di acciai inossidabili, acciai legati, e superleghe. Resistente e robusto substrato di base adatto anche a taglio interrotto.

AK5020**PVD-Mehrlagenbeschichtung**

Hauptwahl und sicherste Sorte für die Bearbeitung von Gusswerkstoffen. Äußerst leistungsfähige Kombination von feinstkörnigem Hartmetall. Anwendungsbereich bei normalen bis stabilen Bedingungen und bei mittleren Schnittgeschwindigkeiten.

PVD-Multilayer coating

Main grade for drilling cast materials. Extreme performance due to combination of fine grain substrate and coating. For use with medium cutting speeds under normal to stable machine conditions.

PVD-Rivestimento multistrato

Prima scelta per la lavorazione di fusioni e ghise. Estremamente valida combinazione di metallo duro micrograna. Applicazioni in normale condizioni di stabilità, con media Velocità di taglio.

3

Hartmetall unbeschichtet / Carbide grade uncoated / Metallo duro non rivestito**AK1010**

Hartmetallsorte für die Bearbeitung von Grauguss (GG), Aluminium und Aluminiumlegierungen, Kupfer und Kupferlegierungen, sowie Bronze und Messing bei mittleren Spanquerschnitten und unter günstigen Bearbeitungsbedingungen.

The main grade for drilling GG cast iron, aluminium, aluminium alloys, copper and copper alloys as well as bronze and brass at medium data and in good machine conditions.

Qualità di metallo duro specifica per la lavorazione di ghisa (GG), e AlluminioLeghe di Alluminio, Rame e leghe di rame, così come Bronzo e Ottone per asportazioni medie e in buone condizioni di lavoro.

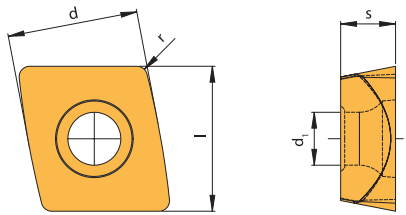

XDMT BS – Geometrie/Geometry/Geometria



Bezeichnung Designation Articolo	l	d	s	d ₁	r	beschichtet coated rivestito		unbeschichtet uncoated non rivestito
						AK5020	AP5030	AK1010
XDMT 042004EN-BS	4,80	4,3	2,0	1,8	0,4	●	●	
XDMT 052504EN-BS	5,70	5,1	2,5	2,3	0,4	●	●	
XDMT 063006EN-BS	6,90	6,2	3,0	2,5	0,6	●	●	
XDMT 073506 EN-BS	8,55	7,7	3,5	2,9	0,6	●	●	
XDMT 094008EN-BS	10,96	9,9	4,0	4,0	0,8	●	●	
XDMT 125012EN-BS	14,14	12,8	5,0	5,5	1,2	●	●	

- **Hauptanwendung**
Main application
Applicazione principale
- **Nebenanwendung**
Secondary application
Applicazione secondaria

	P	M	K	N	S	H
		●				
		●				
	●					
	○					
				○		

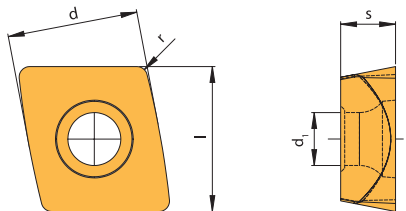

XDMT BM – Geometrie/Geometry/Geometria



Bezeichnung Designation Articolo	l	d	s	d ₁	r	beschichtet coated rivestito		unbeschichtet uncoated non rivestito
						AK5020	AP5030	AK1010
XDMT 042004EN-BM	4,80	4,3	2,0	1,8	0,4	●	●	
XDMT 052504EN-BM	5,70	5,1	2,5	2,3	0,4	●	●	
XDMT 063006EN-BM	6,90	6,2	3,0	2,5	0,6	●	●	
XDMT 073506 EN-BM	8,55	7,7	3,5	2,9	0,6	●	●	
XDMT 094008EN-BM	10,96	9,9	4,0	4,0	0,8	●	●	
XDMT 125012EN-BM	14,14	12,8	5,0	5,5	1,2	●	●	

- **Hauptanwendung**
Main application
Applicazione principale
- **Nebenanwendung**
Secondary application
Applicazione secondaria

	P	M	K	N	S	H
		●				
		●				
	●					
	○					
				○		

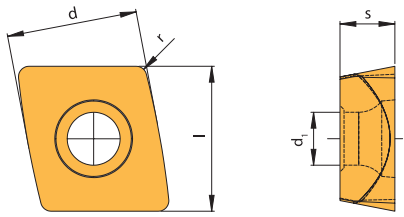

XDMT BR – Geometrie/Geometry/Geometria



Bezeichnung Designation Articolo	l	d	s	d ₁	r	beschichtet coated rivestito		unbeschichtet uncoated non rivestito
						AK5020	AP5030	AK1010
XDMT 042004EN-BR	4,80	4,3	2,0	1,8	0,4	●	●	
XDMT 052504EN-BR	5,70	5,1	2,5	2,3	0,4	●	●	
XDMT 063006EN-BR	6,90	6,2	3,0	2,5	0,6	●	●	
XDMT 073506EN-BR	8,55	7,7	3,5	2,9	0,6	●	●	
XDMT 094008EN-BR	10,96	9,9	4,0	4,0	0,8	●	●	
XDMT 125012EN-BR	14,14	12,8	5,0	5,5	1,2	●	●	

- **Hauptanwendung**
Main application
Applicazione principale
- **Nebenanwendung**
Secondary application
Applicazione secondaria

	P	M	K	N	S	H
		●				
		●				
	●					
	○					
				○		

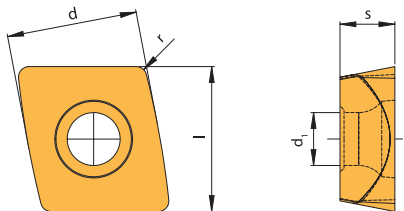

XDMT BAL – Geometrie/Geometry/Geometria



Bezeichnung Designation Articolo	l	d	s	d ₁	r	beschichtet coated rivestito		unbeschichtet uncoated non rivestito
						AK5020	AP5030	AK1010
XDMT 042004EN-BAL	4,80	4,3	2,0	1,8	0,4			●
XDMT 052504EN-BAL	5,70	5,1	2,5	2,3	0,4			●
XDMT 063006EN-BAL	6,90	6,2	3,0	2,5	0,6			●
XDMT 073506EN-BAL	8,55	7,7	3,5	2,9	0,6			●
XDMT 094008EN-BAL	10,96	9,9	4,0	4,0	0,8			●
XDMT 125012EN-BAL	14,14	12,8	5,0	5,5	1,2			●

Auf Anfrage auch beschichtet erhältlich.
On request also available as coated insert.
Su richiesta anche rivestito.

- **Hauptanwendung**
Main application
Applicazione principale
- **Nebenanwendung**
Secondary application
Applicazione secondaria

	P	M	K	N	S	H
						●

Schrauben und Schraubendreher / Screws and Screwdrivers / Chiavi e Viti

Klemmschraube Screws Vite	Schlüssel Key Chiave	max. Anzugsmoment Torque max. Forza di serraggio max.	Wendeschneidplatte Insert Inserto
SS 4104	T5106-IP	0,6 Nm	XDMT 04...
SS 4105	T5106-IP	0,8 Nm	XDMT 05...
SS 4106	T5107-IP	1,0 Nm	XDMT 06...
SS 4107	T5108-IP	1,0 Nm	XDMT 07...
SS 4109	T5115-IP	3,0 Nm	XDMT 09...
SS 4112	T5120-IP	5,0 Nm	XDMT 12...

Hinweis: Drehmoment-Schraubendreher siehe Seite 281.

Remark: For torque screwdrivers see page 281.

Nota: Chiavi dinamometriche a pagina 281.



Schnittwertempfehlung 2xD

ISO	Werkstoff	Zugfestigkeit [N/mm ²]	Geometrie	Sorte	Schnitt- geschwindigkeit V _c [m/min]	Vorschub f [mm/U]			
						14,0–18,0 mm	18,5–29,0 mm	29,5–36,0 mm	37,0–45,0 mm
P	Automatenstähle und Baustähle	440	BS	AP5030	150 - 220 - 250	0,04 - 0,08 - 0,12	0,04 - 0,08 - 0,12	0,04 - 0,08 - 0,13	0,05 - 0,10 - 0,15
		670	BM	AP5030	150 - 220 - 250	0,08 - 0,13 - 0,24	0,04 - 0,13 - 0,24	0,08 - 0,14 - 0,26	0,09 - 0,16 - 0,29
		880	BM	AP5030	125 - 170 - 230	0,06 - 0,11 - 0,18	0,06 - 0,11 - 0,18	0,06 - 0,12 - 0,19	0,07 - 0,13 - 0,22
		980	BM	AP5030	125 - 170 - 230	0,08 - 0,13 - 0,22	0,08 - 0,14 - 0,24	0,08 - 0,14 - 0,23	0,09 - 0,16 - 0,26
		1050	BM	AP5030	100 - 130 - 170	0,06 - 0,11 - 0,17	0,06 - 0,12 - 0,18	0,06 - 0,12 - 0,18	0,07 - 0,13 - 0,20
	Unleg. und niedrig legierter Stahl beinhaltet auch Vergütungsstähle und Einsatzstähle, legierter Stahl	640	BS	AP5030	150 - 180 - 220	0,05 - 0,08 - 0,14	0,05 - 0,08 - 0,14	0,05 - 0,08 - 0,16	0,06 - 0,09 - 0,17
		970	BM	AP5030	125 - 150 - 200	0,06 - 0,11 - 0,17	0,06 - 0,11 - 0,17	0,06 - 0,12 - 0,18	0,07 - 0,13 - 0,20
		1050	BM	AP5030	100 - 140 - 170	0,06 - 0,11 - 0,17	0,06 - 0,11 - 0,17	0,06 - 0,12 - 0,18	0,07 - 0,13 - 0,20
		1230	BM	AP5030	80 - 120 - 150	0,06 - 0,11 - 0,17	0,06 - 0,11 - 0,17	0,06 - 0,12 - 0,18	0,07 - 0,13 - 0,20
	Hochlegierter und hochfester Stahl, Werkzeugstähle	700	BM	AP5030	100 - 150 - 200	0,08 - 0,13 - 0,24	0,08 - 0,13 - 0,24	0,08 - 0,14 - 0,26	0,09 - 0,16 - 0,29
1140		BM	AP5030	80 - 120 - 160	0,06 - 0,11 - 0,18	0,06 - 0,11 - 0,18	0,06 - 0,12 - 0,19	0,07 - 0,13 - 0,22	
M	Nichtrostender Stahl und Stahlguss	700	BS/BM	AP5030	100 - 150 - 200	0,06 - 0,11 - 0,18	0,06 - 0,11 - 0,18	0,06 - 0,12 - 0,19	0,07 - 0,13 - 0,22
		840	BS/BM	AP5030	90 - 120 - 150	0,06 - 0,11 - 0,18	0,06 - 0,11 - 0,18	0,06 - 0,12 - 0,19	0,07 - 0,13 - 0,22
		640	BS/BM	AP5030	100 - 150 - 200	0,04 - 0,08 - 0,18	0,06 - 0,11 - 0,18	0,06 - 0,12 - 0,19	0,07 - 0,13 - 0,22
		810	BS/BM	AP5030	80 - 120 - 150	0,04 - 0,08 - 0,18	0,06 - 0,11 - 0,18	0,06 - 0,12 - 0,19	0,07 - 0,13 - 0,22
K	Grauguss	640	BR	AK5020	120 - 160 - 200	0,09 - 0,20 - 0,32	0,10 - 0,22 - 0,36	0,11 - 0,24 - 0,39	0,12 - 0,26 - 0,44
		910	BR	AK5020	120 - 160 - 200	0,09 - 0,20 - 0,32	0,10 - 0,22 - 0,36	0,11 - 0,24 - 0,39	0,12 - 0,26 - 0,44
	Gusseisen mit Kugelgraphit, Temperguss	560	BR	AK5020	90 - 120 - 250	0,09 - 0,20 - 0,32	0,10 - 0,22 - 0,36	0,11 - 0,24 - 0,39	0,12 - 0,26 - 0,44
		880	BR	AK5020	90 - 120 - 150	0,09 - 0,20 - 0,32	0,10 - 0,22 - 0,36	0,11 - 0,24 - 0,39	0,12 - 0,26 - 0,44
N	Aluminium-Knetlegierungen Aluminium-Gusslegierungen		BAL	AK1010	200 - 260 - 320	0,06 - 0,11 - 0,17	0,06 - 0,11 - 0,17	0,06 - 0,12 - 0,18	0,07 - 0,13 - 0,20
	Kupfer und Kupferlegierungen (Bronze / Messing)		BAL	AK1010	180 - 230 - 280	0,06 - 0,11 - 0,17	0,06 - 0,11 - 0,17	0,06 - 0,12 - 0,18	0,07 - 0,13 - 0,20
S	Warmfeste Legierungen/Superlegierungen Titanlegierungen/Titan	700	BS/BM	AP5030	25 - 50 - 70	0,06 - 0,11 - 0,18	0,06 - 0,11 - 0,18	0,06 - 0,12 - 0,19	0,07 - 0,13 - 0,22



Schnittwertempfehlung 3xD

ISO	Werkstoff	Zugfestigkeit [N/mm ²]	Geometrie	Sorte	Schnitt- geschwindigkeit V _c [m/min]	Vorschub f [mm/U]			
						14,0–18,0 mm	18,5–29,0 mm	29,5–36,0 mm	37,0–45,0 mm
P	Automatenstähle und Baustähle	440	BS	AP5030	150 - 220 - 250	0,04 - 0,07 - 0,10	0,04 - 0,07 - 0,10	0,04 - 0,08 - 0,11	0,05 - 0,09 - 0,12
		670	BM	AP5030	150 - 220 - 250	0,08 - 0,12 - 0,20	0,08 - 0,12 - 0,20	0,08 - 0,13 - 0,22	0,09 - 0,14 - 0,24
		880	BM	AP5030	125 - 170 - 230	0,06 - 0,10 - 0,15	0,06 - 0,10 - 0,15	0,06 - 0,11 - 0,16	0,07 - 0,12 - 0,18
		980	BM	AP5030	125 - 170 - 230	0,08 - 0,12 - 0,18	0,08 - 0,12 - 0,18	0,08 - 0,13 - 0,19	0,09 - 0,14 - 0,22
		1050	BM	AP5030	100 - 130 - 170	0,06 - 0,10 - 0,14	0,06 - 0,10 - 0,14	0,06 - 0,11 - 0,15	0,07 - 0,12 - 0,17
	Unleg. und niedrig legierter Stahl beinhaltet auch Vergütungsstähle und Einsatzstähle, legierter Stahl	640	BS	AP5030	150 - 180 - 220	0,05 - 0,07 - 0,12	0,05 - 0,07 - 0,12	0,05 - 0,08 - 0,13	0,06 - 0,08 - 0,15
		970	BM	AP5030	125 - 150 - 200	0,06 - 0,10 - 0,14	0,06 - 0,10 - 0,14	0,06 - 0,11 - 0,15	0,07 - 0,12 - 0,17
		1050	BM	AP5030	100 - 140 - 170	0,06 - 0,10 - 0,14	0,06 - 0,10 - 0,14	0,06 - 0,11 - 0,15	0,07 - 0,12 - 0,17
		1230	BM	AP5030	80 - 120 - 150	0,06 - 0,10 - 0,14	0,06 - 0,10 - 0,14	0,06 - 0,11 - 0,15	0,07 - 0,12 - 0,17
	Hochlegierter und hochfester Stahl, Werkzeugstähle	700	BM	AP5030	100 - 150 - 200	0,08 - 0,12 - 0,20	0,08 - 0,12 - 0,20	0,08 - 0,13 - 0,22	0,09 - 0,14 - 0,24
1140		BM	AP5030	80 - 120 - 160	0,06 - 0,10 - 0,15	0,06 - 0,10 - 0,15	0,06 - 0,11 - 0,16	0,07 - 0,12 - 0,18	
M	Nichtrostender Stahl und Stahlguss	700	BS/BM	AP5030	100 - 150 - 200	0,06 - 0,10 - 0,15	0,06 - 0,10 - 0,15	0,06 - 0,11 - 0,16	0,07 - 0,12 - 0,18
		840	BS/BM	AP5030	90 - 120 - 150	0,06 - 0,10 - 0,15	0,06 - 0,10 - 0,15	0,06 - 0,11 - 0,16	0,07 - 0,12 - 0,18
		640	BS/BM	AP5030	100 - 150 - 200	0,04 - 0,10 - 0,15	0,06 - 0,10 - 0,15	0,06 - 0,11 - 0,16	0,07 - 0,12 - 0,18
		810	BS/BM	AP5030	80 - 120 - 150	0,04 - 0,10 - 0,15	0,06 - 0,10 - 0,15	0,06 - 0,11 - 0,16	0,07 - 0,12 - 0,18
K	Grauguss	640	BR	AK5020	120 - 160 - 200	0,09 - 0,18 - 0,27	0,10 - 0,20 - 0,30	0,11 - 0,22 - 0,32	0,12 - 0,24 - 0,36
		910	BR	AK5020	120 - 160 - 200	0,09 - 0,18 - 0,27	0,10 - 0,20 - 0,30	0,11 - 0,22 - 0,32	0,12 - 0,24 - 0,36
	Gusseisen mit Kugelgraphit, Temperguss	560	BR	AK5020	90 - 120 - 250	0,09 - 0,18 - 0,27	0,10 - 0,20 - 0,30	0,11 - 0,22 - 0,32	0,12 - 0,24 - 0,36
		880	BR	AK5020	90 - 120 - 150	0,09 - 0,18 - 0,27	0,10 - 0,20 - 0,30	0,11 - 0,22 - 0,32	0,12 - 0,24 - 0,36
N	Aluminium-Knetlegierungen Aluminium-Gusslegierungen		BAL	AK1010	200 - 260 - 320	0,06 - 0,11 - 0,17	0,06 - 0,11 - 0,17	0,06 - 0,12 - 0,18	0,07 - 0,13 - 0,20
	Kupfer und Kupferlegierungen (Bronze / Messing)		BAL	AK1010	180 - 230 - 280	0,06 - 0,11 - 0,17	0,06 - 0,11 - 0,17	0,06 - 0,12 - 0,18	0,07 - 0,13 - 0,20
S	Warmfeste Legierungen/Superlegierungen Titanlegierungen/Titan	700	BS/BM	AP5030	25 - 50 - 70	0,06 - 0,10 - 0,15	0,06 - 0,10 - 0,15	0,06 - 0,11 - 0,16	0,07 - 0,12 - 0,18

Bei neuen Anwendungen mit durchschnittlichen Rahmenbedingungen (z. B. Aufspannung, Kühlmitteldruck und Maschinenstabilität) kann als Startwert die Mitte des Vorschubbereiches gewählt werden. Die Tabellenwerte sind Richtwerte. Es kann notwendig sein, die Werte den jeweiligen Bearbeitungsumständen anzupassen.

Recommendations 2xD

ISO	Material	Toughness [N/mm ²]	Geometry	Grade	Cutting speed V _c [m/min]	Feed rate f [mm/U]			
						14.0-18.0 mm	18.5-29.0 mm	29.5-36.0 mm	37.0-45.0 mm
P	Carbon steel	440	BS	AP5030	150 - 220 - 250	0.04 - 0.08 - 0.12	0.04 - 0.08 - 0.12	0.04 - 0.08 - 0.13	0.05 - 0.10 - 0.15
		670	BM	AP5030	150 - 220 - 250	0.08 - 0.13 - 0.24	0.04 - 0.13 - 0.24	0.08 - 0.14 - 0.26	0.09 - 0.16 - 0.29
		880	BM	AP5030	125 - 170 - 230	0.06 - 0.11 - 0.18	0.06 - 0.11 - 0.18	0.06 - 0.12 - 0.19	0.07 - 0.13 - 0.22
		980	BM	AP5030	125 - 170 - 230	0.08 - 0.13 - 0.22	0.08 - 0.14 - 0.24	0.08 - 0.14 - 0.23	0.09 - 0.16 - 0.26
		1050	BM	AP5030	100 - 130 - 170	0.06 - 0.11 - 0.17	0.06 - 0.12 - 0.18	0.06 - 0.12 - 0.18	0.07 - 0.13 - 0.20
	Low alloyed steel	640	BS	AP5030	150 - 180 - 220	0.05 - 0.08 - 0.14	0.05 - 0.08 - 0.14	0.05 - 0.08 - 0.16	0.06 - 0.09 - 0.17
		970	BM	AP5030	125 - 150 - 200	0.06 - 0.11 - 0.17	0.06 - 0.11 - 0.17	0.06 - 0.12 - 0.18	0.07 - 0.13 - 0.20
		1050	BM	AP5030	100 - 140 - 170	0.06 - 0.11 - 0.17	0.06 - 0.11 - 0.17	0.06 - 0.12 - 0.18	0.07 - 0.13 - 0.20
		1230	BM	AP5030	80 - 120 - 150	0.06 - 0.11 - 0.17	0.06 - 0.11 - 0.17	0.06 - 0.12 - 0.18	0.07 - 0.13 - 0.20
	High alloyed steel	700	BM	AP5030	100 - 150 - 200	0.08 - 0.13 - 0.24	0.08 - 0.13 - 0.24	0.08 - 0.14 - 0.26	0.09 - 0.16 - 0.29
1140		BM	AP5030	80 - 120 - 160	0.06 - 0.11 - 0.18	0.06 - 0.11 - 0.18	0.06 - 0.12 - 0.19	0.07 - 0.13 - 0.22	
M	Stainless Steel	700	BS/BM	AP5030	100 - 150 - 200	0.06 - 0.11 - 0.18	0.06 - 0.11 - 0.18	0.06 - 0.12 - 0.19	0.07 - 0.13 - 0.22
		840	BS/BM	AP5030	90 - 120 - 150	0.06 - 0.11 - 0.18	0.06 - 0.11 - 0.18	0.06 - 0.12 - 0.19	0.07 - 0.13 - 0.22
		640	BS/BM	AP5030	100 - 150 - 200	0.04 - 0.08 - 0.18	0.06 - 0.11 - 0.18	0.06 - 0.12 - 0.19	0.07 - 0.13 - 0.22
		810	BS/BM	AP5030	80 - 120 - 150	0.04 - 0.08 - 0.18	0.06 - 0.11 - 0.18	0.06 - 0.12 - 0.19	0.07 - 0.13 - 0.22
K	Cast iron (GG)	640	BR	AK5020	120 - 160 - 200	0.09 - 0.20 - 0.32	0.10 - 0.22 - 0.36	0.11 - 0.24 - 0.39	0.12 - 0.26 - 0.44
		910	BR	AK5020	120 - 160 - 200	0.09 - 0.20 - 0.32	0.10 - 0.22 - 0.36	0.11 - 0.24 - 0.39	0.12 - 0.26 - 0.44
	Nodular cast iron (GGG)	560	BR	AK5020	90 - 120 - 250	0.09 - 0.20 - 0.32	0.10 - 0.22 - 0.36	0.11 - 0.24 - 0.39	0.12 - 0.26 - 0.44
880		BR	AK5020	90 - 120 - 150	0.09 - 0.20 - 0.32	0.10 - 0.22 - 0.36	0.11 - 0.24 - 0.39	0.12 - 0.26 - 0.44	
N	Aluminium alloy		BAL	AK1010	200 - 260 - 320	0.06 - 0.11 - 0.17	0.06 - 0.11 - 0.17	0.06 - 0.12 - 0.18	0.07 - 0.13 - 0.20
	Copper alloy		BAL	AK1010	180 - 230 - 280	0.06 - 0.11 - 0.17	0.06 - 0.11 - 0.17	0.06 - 0.12 - 0.18	0.07 - 0.13 - 0.20
S	Heat resistant alloy	700	BS/BM	AP5030	25 - 50 - 70	0.06 - 0.11 - 0.18	0.06 - 0.11 - 0.18	0.06 - 0.12 - 0.19	0.07 - 0.13 - 0.22

3

Recommendations 3xD

ISO	Material	Toughness [N/mm ²]	Geometry	Grade	Cutting speed V _c [m/min]	Feed rate f [mm/U]			
						14.0-18.0 mm	18.5-29.0 mm	29.5-36.0 mm	37.0-45.0 mm
P	Carbon steel	440	BS	AP5030	150 - 220 - 250	0.04 - 0.07 - 0.10	0.04 - 0.07 - 0.10	0.04 - 0.08 - 0.11	0.05 - 0.09 - 0.12
		670	BM	AP5030	150 - 220 - 250	0.08 - 0.12 - 0.20	0.08 - 0.12 - 0.20	0.08 - 0.13 - 0.22	0.09 - 0.14 - 0.24
		880	BM	AP5030	125 - 170 - 230	0.06 - 0.10 - 0.15	0.06 - 0.10 - 0.15	0.06 - 0.11 - 0.16	0.07 - 0.12 - 0.18
		980	BM	AP5030	125 - 170 - 230	0.08 - 0.12 - 0.18	0.08 - 0.12 - 0.18	0.08 - 0.13 - 0.19	0.09 - 0.14 - 0.22
		1050	BM	AP5030	100 - 130 - 170	0.06 - 0.10 - 0.14	0.06 - 0.10 - 0.14	0.06 - 0.11 - 0.15	0.07 - 0.12 - 0.17
	Low alloyed steel	640	BS	AP5030	150 - 180 - 220	0.05 - 0.07 - 0.12	0.05 - 0.07 - 0.12	0.05 - 0.08 - 0.13	0.06 - 0.08 - 0.15
		970	BM	AP5030	125 - 150 - 200	0.06 - 0.10 - 0.14	0.06 - 0.10 - 0.14	0.06 - 0.11 - 0.15	0.07 - 0.12 - 0.17
		1050	BM	AP5030	100 - 140 - 170	0.06 - 0.10 - 0.14	0.06 - 0.10 - 0.14	0.06 - 0.11 - 0.15	0.07 - 0.12 - 0.17
		1230	BM	AP5030	80 - 120 - 150	0.06 - 0.10 - 0.14	0.06 - 0.10 - 0.14	0.06 - 0.11 - 0.15	0.07 - 0.12 - 0.17
	High alloyed steel	700	BM	AP5030	100 - 150 - 200	0.08 - 0.12 - 0.20	0.08 - 0.12 - 0.20	0.08 - 0.13 - 0.22	0.09 - 0.14 - 0.24
1140		BM	AP5030	80 - 120 - 160	0.06 - 0.10 - 0.15	0.06 - 0.10 - 0.15	0.06 - 0.11 - 0.16	0.07 - 0.12 - 0.18	
M	Stainless Steel	700	BS/BM	AP5030	100 - 150 - 200	0.06 - 0.10 - 0.15	0.06 - 0.10 - 0.15	0.06 - 0.11 - 0.16	0.07 - 0.12 - 0.18
		840	BS/BM	AP5030	90 - 120 - 150	0.06 - 0.10 - 0.15	0.06 - 0.10 - 0.15	0.06 - 0.11 - 0.16	0.07 - 0.12 - 0.18
		640	BS/BM	AP5030	100 - 150 - 200	0.04 - 0.10 - 0.15	0.06 - 0.10 - 0.15	0.06 - 0.11 - 0.16	0.07 - 0.12 - 0.18
		810	BS/BM	AP5030	80 - 120 - 150	0.04 - 0.10 - 0.15	0.06 - 0.10 - 0.15	0.06 - 0.11 - 0.16	0.07 - 0.12 - 0.18
K	Cast iron (GG)	640	BR	AK5020	120 - 160 - 200	0.09 - 0.18 - 0.27	0.10 - 0.20 - 0.30	0.11 - 0.22 - 0.32	0.12 - 0.24 - 0.36
		910	BR	AK5020	120 - 160 - 200	0.09 - 0.18 - 0.27	0.10 - 0.20 - 0.30	0.11 - 0.22 - 0.32	0.12 - 0.24 - 0.36
	Nodular cast iron (GGG)	560	BR	AK5020	90 - 120 - 250	0.09 - 0.18 - 0.27	0.10 - 0.20 - 0.30	0.11 - 0.22 - 0.32	0.12 - 0.24 - 0.36
880		BR	AK5020	90 - 120 - 150	0.09 - 0.18 - 0.27	0.10 - 0.20 - 0.30	0.11 - 0.22 - 0.32	0.12 - 0.24 - 0.36	
N	Aluminium alloy		BAL	AK1010	200 - 260 - 320	0.06 - 0.11 - 0.17	0.06 - 0.11 - 0.17	0.06 - 0.12 - 0.18	0.07 - 0.13 - 0.20
	Copper alloy		BAL	AK1010	180 - 230 - 280	0.06 - 0.11 - 0.17	0.06 - 0.11 - 0.17	0.06 - 0.12 - 0.18	0.07 - 0.13 - 0.20
S	Heat resistant alloy	700	BS/BM	AP5030	25 - 50 - 70	0.06 - 0.10 - 0.15	0.06 - 0.10 - 0.15	0.06 - 0.11 - 0.16	0.07 - 0.12 - 0.18

For applications with average conditions (work holding, coolant pressure and stability) please use the middle recommendation. The values are only recommendations, it may be necessary to adjust in line with machining conditions.

Parametri di taglio 2xD

ISO	Materiale	Resistenza [N/mm ²]	Geometria	Qualità	Velocità di taglio V _c [m/min]	Avanzamento f [mm/U]			
						14,0-18,0 mm	18,5-29,0 mm	29,5-36,0 mm	37,0-45,0 mm
P	Acciai automatici e debolmente legati	440	BS	AP5030	150 - 220 - 250	0,04 - 0,08 - 0,12	0,04 - 0,08 - 0,12	0,04 - 0,08 - 0,13	0,05 - 0,10 - 0,15
		670	BM	AP5030	150 - 220 - 250	0,08 - 0,13 - 0,24	0,04 - 0,13 - 0,24	0,08 - 0,14 - 0,26	0,09 - 0,16 - 0,29
		880	BM	AP5030	125 - 170 - 230	0,06 - 0,11 - 0,18	0,06 - 0,11 - 0,18	0,06 - 0,12 - 0,19	0,07 - 0,13 - 0,22
		980	BM	AP5030	125 - 170 - 230	0,08 - 0,13 - 0,22	0,08 - 0,14 - 0,24	0,08 - 0,14 - 0,23	0,09 - 0,16 - 0,26
		1050	BM	AP5030	100 - 130 - 170	0,06 - 0,11 - 0,17	0,06 - 0,12 - 0,18	0,06 - 0,12 - 0,18	0,07 - 0,13 - 0,20
	Acciai debolmente legati, legati, acciai da fusione, acciai da bonifica	640	BS	AP5030	150 - 180 - 220	0,05 - 0,08 - 0,14	0,05 - 0,08 - 0,14	0,05 - 0,08 - 0,16	0,06 - 0,09 - 0,17
		970	BM	AP5030	125 - 150 - 200	0,06 - 0,11 - 0,17	0,06 - 0,11 - 0,17	0,06 - 0,12 - 0,18	0,07 - 0,13 - 0,20
		1050	BM	AP5030	100 - 140 - 170	0,06 - 0,11 - 0,17	0,06 - 0,11 - 0,17	0,06 - 0,12 - 0,18	0,07 - 0,13 - 0,20
		1230	BM	AP5030	80 - 120 - 150	0,06 - 0,11 - 0,17	0,06 - 0,11 - 0,17	0,06 - 0,12 - 0,18	0,07 - 0,13 - 0,20
	Acciai Fortemente legati, acciai da costruzione, acciai stampati	700	BM	AP5030	100 - 150 - 200	0,08 - 0,13 - 0,24	0,08 - 0,13 - 0,24	0,08 - 0,14 - 0,26	0,09 - 0,16 - 0,29
1140		BM	AP5030	80 - 120 - 160	0,06 - 0,11 - 0,18	0,06 - 0,11 - 0,18	0,06 - 0,12 - 0,19	0,07 - 0,13 - 0,22	
M	Acciai Inossidabili e Ghise acciaiose	700	BS/BM	AP5030	100 - 150 - 200	0,06 - 0,11 - 0,18	0,06 - 0,11 - 0,18	0,06 - 0,12 - 0,19	0,07 - 0,13 - 0,22
		840	BS/BM	AP5030	90 - 120 - 150	0,06 - 0,11 - 0,18	0,06 - 0,11 - 0,18	0,06 - 0,12 - 0,19	0,07 - 0,13 - 0,22
		640	BS/BM	AP5030	100 - 150 - 200	0,04 - 0,08 - 0,18	0,06 - 0,11 - 0,18	0,06 - 0,12 - 0,19	0,07 - 0,13 - 0,22
		810	BS/BM	AP5030	80 - 120 - 150	0,04 - 0,08 - 0,18	0,06 - 0,11 - 0,18	0,06 - 0,12 - 0,19	0,07 - 0,13 - 0,22
K	Ghise grigie	640	BR	AK5020	120 - 160 - 200	0,09 - 0,20 - 0,32	0,10 - 0,22 - 0,36	0,11 - 0,24 - 0,39	0,12 - 0,26 - 0,44
		910	BR	AK5020	120 - 160 - 200	0,09 - 0,20 - 0,32	0,10 - 0,22 - 0,36	0,11 - 0,24 - 0,39	0,12 - 0,26 - 0,44
	Ghisa sferoidale, ghise temprate	560	BR	AK5020	90 - 120 - 250	0,09 - 0,20 - 0,32	0,10 - 0,22 - 0,36	0,11 - 0,24 - 0,39	0,12 - 0,26 - 0,44
		880	BR	AK5020	90 - 120 - 150	0,09 - 0,20 - 0,32	0,10 - 0,22 - 0,36	0,11 - 0,24 - 0,39	0,12 - 0,26 - 0,44
N	Alluminio e relative leghe		BAL	AK1010	200 - 260 - 320	0,06 - 0,11 - 0,17	0,06 - 0,11 - 0,17	0,06 - 0,12 - 0,18	0,07 - 0,13 - 0,20
	Rame, leghe di Rame (Ottone, Bronzo)		BAL	AK1010	180 - 230 - 280	0,06 - 0,11 - 0,17	0,06 - 0,11 - 0,17	0,06 - 0,12 - 0,18	0,07 - 0,13 - 0,20
S	Leghe resistenti al calore, Superleghe, leghe di Titanio	700	BS/BM	AP5030	25 - 50 - 70	0,06 - 0,11 - 0,18	0,06 - 0,11 - 0,18	0,06 - 0,12 - 0,19	0,07 - 0,13 - 0,22

3

Parametri di taglio 3xD

ISO	Materiale	Resistenza [N/mm ²]	Geometria	Qualità	Velocità di taglio V _c [m/min]	Avanzamento f [mm/U]			
						14,0-18,0 mm	18,5-29,0 mm	29,5-36,0 mm	37,0-45,0 mm
P	Acciai automatici e debolmente legati	440	BS	AP5030	150 - 220 - 250	0,04 - 0,07 - 0,10	0,04 - 0,07 - 0,10	0,04 - 0,08 - 0,11	0,05 - 0,09 - 0,12
		670	BM	AP5030	150 - 220 - 250	0,08 - 0,12 - 0,20	0,08 - 0,12 - 0,20	0,08 - 0,13 - 0,22	0,09 - 0,14 - 0,24
		880	BM	AP5030	125 - 170 - 230	0,06 - 0,10 - 0,15	0,06 - 0,10 - 0,15	0,06 - 0,11 - 0,16	0,07 - 0,12 - 0,18
		980	BM	AP5030	125 - 170 - 230	0,08 - 0,12 - 0,18	0,08 - 0,12 - 0,18	0,08 - 0,13 - 0,19	0,09 - 0,14 - 0,22
		1050	BM	AP5030	100 - 130 - 170	0,06 - 0,10 - 0,14	0,06 - 0,10 - 0,14	0,06 - 0,11 - 0,15	0,07 - 0,12 - 0,17
	Acciai debolmente legati, legati, acciai da fusione, acciai da bonifica	640	BS	AP5030	150 - 180 - 220	0,05 - 0,07 - 0,12	0,05 - 0,07 - 0,12	0,05 - 0,08 - 0,13	0,06 - 0,08 - 0,15
		970	BM	AP5030	125 - 150 - 200	0,06 - 0,10 - 0,14	0,06 - 0,10 - 0,14	0,06 - 0,11 - 0,15	0,07 - 0,12 - 0,17
		1050	BM	AP5030	100 - 140 - 170	0,06 - 0,10 - 0,14	0,06 - 0,10 - 0,14	0,06 - 0,11 - 0,15	0,07 - 0,12 - 0,17
		1230	BM	AP5030	80 - 120 - 150	0,06 - 0,10 - 0,14	0,06 - 0,10 - 0,14	0,06 - 0,11 - 0,15	0,07 - 0,12 - 0,17
	Acciai Fortemente legati, acciai da costruzione, acciai stampati	700	BM	AP5030	100 - 150 - 200	0,08 - 0,12 - 0,20	0,08 - 0,12 - 0,20	0,08 - 0,13 - 0,22	0,09 - 0,14 - 0,24
1140		BM	AP5030	80 - 120 - 160	0,06 - 0,10 - 0,15	0,06 - 0,10 - 0,15	0,06 - 0,11 - 0,16	0,07 - 0,12 - 0,18	
M	Acciai Inossidabili e Ghise acciaiose	700	BS/BM	AP5030	100 - 150 - 200	0,06 - 0,10 - 0,15	0,06 - 0,10 - 0,15	0,06 - 0,11 - 0,16	0,07 - 0,12 - 0,18
		840	BS/BM	AP5030	90 - 120 - 150	0,06 - 0,10 - 0,15	0,06 - 0,10 - 0,15	0,06 - 0,11 - 0,16	0,07 - 0,12 - 0,18
		640	BS/BM	AP5030	100 - 150 - 200	0,04 - 0,10 - 0,15	0,06 - 0,10 - 0,15	0,06 - 0,11 - 0,16	0,07 - 0,12 - 0,18
		810	BS/BM	AP5030	80 - 120 - 150	0,04 - 0,10 - 0,15	0,06 - 0,10 - 0,15	0,06 - 0,11 - 0,16	0,07 - 0,12 - 0,18
K	Ghise grigie	640	BR	AK5020	120 - 160 - 200	0,09 - 0,18 - 0,27	0,10 - 0,20 - 0,30	0,11 - 0,22 - 0,32	0,12 - 0,24 - 0,36
		910	BR	AK5020	120 - 160 - 200	0,09 - 0,18 - 0,27	0,10 - 0,20 - 0,30	0,11 - 0,22 - 0,32	0,12 - 0,24 - 0,36
	Ghisa sferoidale, ghise temprate	560	BR	AK5020	90 - 120 - 250	0,09 - 0,18 - 0,27	0,10 - 0,20 - 0,30	0,11 - 0,22 - 0,32	0,12 - 0,24 - 0,36
		880	BR	AK5020	90 - 120 - 150	0,09 - 0,18 - 0,27	0,10 - 0,20 - 0,30	0,11 - 0,22 - 0,32	0,12 - 0,24 - 0,36
N	Alluminio e relative leghe		BAL	AK1010	200 - 260 - 320	0,06 - 0,11 - 0,17	0,06 - 0,11 - 0,17	0,06 - 0,12 - 0,18	0,07 - 0,13 - 0,20
	Rame, leghe di Rame (Ottone, Bronzo)		BAL	AK1010	180 - 230 - 280	0,06 - 0,11 - 0,17	0,06 - 0,11 - 0,17	0,06 - 0,12 - 0,18	0,07 - 0,13 - 0,20
S	Leghe resistenti al calore, Superleghe, leghe di Titanio	700	BS/BM	AP5030	25 - 50 - 70	0,06 - 0,10 - 0,15	0,06 - 0,10 - 0,15	0,06 - 0,11 - 0,16	0,07 - 0,12 - 0,18

I parametri di taglio sono indicativi e riferiti a condizioni di taglio e di lavoro ottimali. A seconda delle condizioni di lavoro (staffaggio, rigidità di macchina e pezzo, qualità del refrigerante etc...) può essere necessario adattare tali valori.

Anbohren auf unebenen Flächen (Gussflächen)

Drilling into poor surfaces

Foratura su superfici irregolari (crosta di fusione)

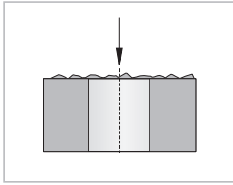

- Je nach Qualität der Oberfläche muss gegebenenfalls der Vorschub beim Anbohren reduziert werden
- Depending on quality of surface, feed rate may need to be reduced
- A seconda della qualità della superficie potrebbe essere necessario ridurre l'avanzamento in ingresso

Anbohren auf balligen Flächen

Drilling into a cambered surface

Foratura su superfici sferiche o cilindriche

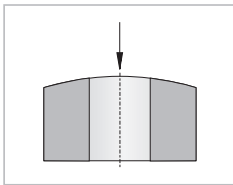

- Gegebenenfalls den Vorschub reduzieren
- Reducing feed rate may be required
- Ridurre l'avanzamento fino al raggiungimento del diametro nominale

Anbohren auf schrägen Flächen

Drilling into an angle

Foratura su piani inclinati

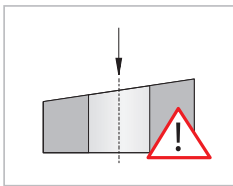

- Bis max 3° Schräglage keine Vorschubreduzierung erforderlich (Guss-schrägen)
- >3° Schräglage, Vorschub um 50–70% reduzieren/ bis zum Erreichen des vollen Nenndurchmessers
- Stablen Eckenradius verwenden
- Up to maximum 3° no need to reduce feed rate
- Above 3° reduce feed rate by 50–70% until drill is in full cut
- Use strong edge radius
- Max 3° inclinazione non richiede riduzione dell'avanzamento (Angoli di sforno fusioni)
- > 3° di inclinazione, ridurre l'avanzamento del 50–70% fino al raggiungimento del diametro nominale
- Utilizzare geometrie robuste di taglio

Querbohrungen

Cross-hole drilling

Intersezione di fori

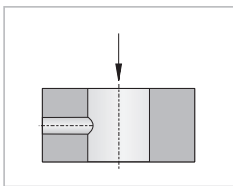

- Vorschub um 50–70% reduzieren
- Auf verklemmte Späne achten
- Zähre WSP-Sorte verwenden
- Stablen Eckenradius verwenden
- Reduce feed rate by 50–70%
- Be aware of swarf jamming
- Use tough carbide grade
- Use strong edge radius
- Ridurre l'avanzamento del 50–70%
- Assicurarsi che trucioli non rimangano incastrati nei fori
- Utilizzare una qualità di metallo duro tenace
- Scegliere una geometria di taglio robusta

Schräger Bohrungsausritt

Drilling exit into an angle

Foro in uscita su piano inclinato

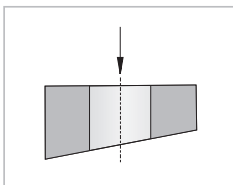

- >3° Schräglage: Vorschub ab Schnittunterbrechung um 50–70% reduzieren
- Zähre WSP-Sorte verwenden
- Stablen Eckenradius verwenden
- Above 3° reduce feed rate by 50–70% until drill is in full cut
- Use tough carbide grade
- Use strong edge radius
- > 3° di inclinazione: riduzione del 50–70% avanzamento nell'ultima parte di foro
- Utilizzare inserto con geometria robusta
- Utilizzare Qualità tenace di metallo duro

3

Bohren einer Auskesselung

Drilling of chamber

Svuotamento di una tasca

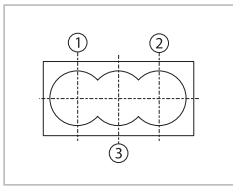

- Reihenfolge (siehe Bild) beachten
- Auf symmetrische Aufteilung achten
- Vorschub um 50–70 % reduzieren
- Zähle WSP-Sorte verwenden
- Stablen Eckenradius verwenden

- Drill in order as shown on picture
- Ensure symmetrical machining
- Reduce feed rate by 50–70 %
- Use tough carbide grade
- Use strong edge radius

- Seguire la sequenza (vedi immagine a lato)
- Rispettare la simmetria delle posizioni
- Ridurre l'avanzamento del 50–70 % solo per i fori non dal pieno
- Scegliere una qualità tenace di metallo duro
- Utilizzare una geometria robusta di taglio

Anbohren einer Sicke oder großen Zentrierbohrung

Drilling into groove or large centre bore Spot

Foratura non dal pieno o su preforo

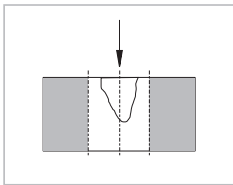

- Gegebenenfalls vorher Plansenken
- Vorschub reduzieren

- Facing may be required
- Reduce feed rate

- Se possibile allargare l'imbocco al diametro della punta
- Ridurre l'avanzamento fino al pieno della lavorazione

Anbohren auf einer Schmiede-, Schweiß- oder Gussnaht

Drilling into welded seam

Foratura su superfici saldate o con bave

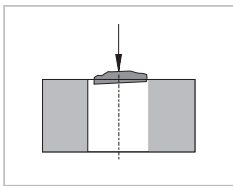

- Vorschub reduzieren

- Reduce feed rate

- Ridurre l'avanzamento fino alla asportazione del sovrametallo

Anbohren auf einer Kante

Drilling into edge

Foratura su piani non paralleli o su spigoli

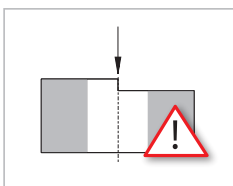

- Aufgrund der undefinierten Anbohrfläche muss vorbearbeitet werden (Plansenken/Planfräsen)

- Must be prepared by either spot facing or face milling

- Sconsigliato l'uso, preferibile fresare il profilo pareggiando i piani

Aufbohren

Boring

Barenatura

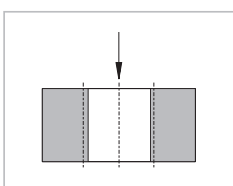

- Spanverklümmungen vermeiden
- Eventuell Werkzeugträger im Durchmesser reduzieren

- Avoid swarf jamming
- Possibly reduce diameter of drill body

- Controllare l'evacuazione e la formazione del truciolo
- Controllare le forze di taglio per un miglior controllo dimensionale

Bohren ins Volle außer Mitte / Drilling off centre / Foratura dal pieno

Durch Versetzen der Mittelachse des Bohrers in Richtung der Außenschneide um den Betrag „x“ kann eine größere Bohrung erzeugt werden. Bitte versetzen Sie die X-Achse innerhalb des Maximalwertes aus nebenstehender Tabelle.

By offsetting the centreline of the drill in the direction of the outside pocket by a maximum of "x" it is possible to create a larger diameter bore. Please do not offset above the max values in chart.

E' possibile compensare la posizione dell'asse di lavoro per ottenere fori maggiorati rispetto al diametro nominale della punta. Attenzione: è solamente possibile incrementare in positivo lungo l'asse dei taglienti del valore "X" secondo la tabella a fianco.

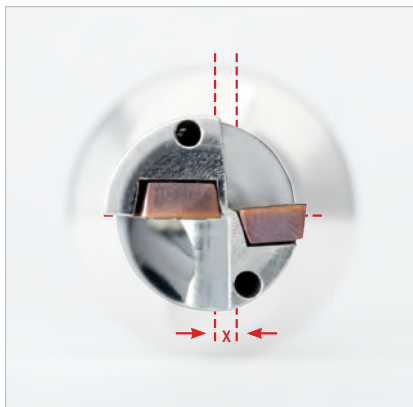

Durchmesser Grundhalter Diameter Holder Diametro Nominale [mm]	Max. Achsversetzung Max offset Max disassamento [mm]
14,0	0,25
14,5	0,20
15,0	0,15
15,5	0,40
16,0	0,40
16,5	0,35
17,0	0,30
17,5	0,25
18,0	0,20
18,5	0,50
19,0	0,45
19,5	0,40
20,0	0,30
20,5	0,30
21,0	0,20
21,5	0,15
22,0	0,10
22,5	0,06
23,0	0,70
23,5	0,70
24,0	0,60
24,5	0,50
25,0	0,50
25,5	0,45

Durchmesser Grundhalter Diameter Holder Diametro Nominale [mm]	Max. Achsversetzung Max offset Max disassamento [mm]
26,0	0,40
26,5	0,35
27,0	0,25
27,5	0,20
28,0	0,15
28,5	0,10
29,0	1,00
29,5	0,95
30,0	0,90
31,0	0,80
32,0	0,70
33,0	0,55
34,0	0,45
35,0	0,35
36,0	0,20
37,0	1,00
38,0	1,00
39,0	0,90
40,0	0,80
41,0	0,70
42,0	0,60
43,0	0,50
44,0	0,50
45,0	0,40

Die Tabellenwerte sind Richtwerte. Reduzieren Sie die Vorschubgeschwindigkeit auf 30%. Es kann notwendig sein, die Werte den jeweiligen Bearbeitungsumständen anzupassen.

The chart values are recommendations, reduce feed rate to 30%. Values may change depending on application.

I valori della tabella sono indicativi. Ridurre la velocità di avanzamento del 30%. Può essere necessario adattare i parametri di taglio alle condizioni di lavoro fuori asse.

Bohrgrund / Hole surface finish / Fondo del foro

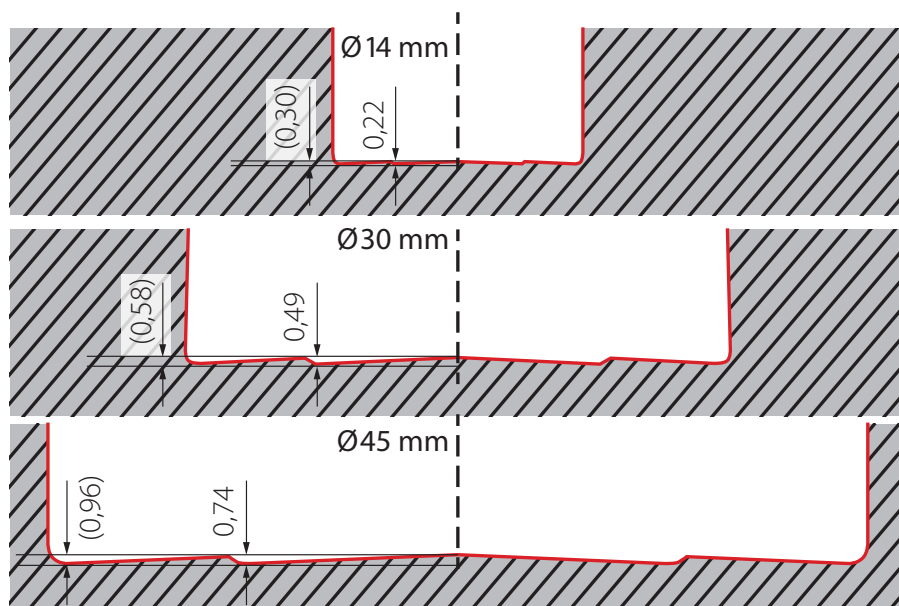



SHARK-Cut®

- Systemvorstellung
- Bezeichnungssystem
- Werkzeugauswahl
- SHARK-Cut® Mini
- SHARK-Cut® Standard
- SHARK-Cut® Rebore
- Wendeschneidplatten
 - Geometriebeschreibung
 - Sortenbeschreibung
- Ersatzteile
- Schnittwerte
- Anwendungshinweise

SHARK-Cut®

- Introduction
- Designation system
- Tool shank options
- SHARK-Cut® Mini
- SHARK-Cut® Standard
- SHARK-Cut® Rebore
- Inserts
 - Geometry description
 - Grade description
- Spare parts
- Cutting data
- Application reference

SHARK-Cut®

- Caratteristiche del sistema
- Sistema di numerazione
- Tipologie di numerazione
- SHARK-Cut® Mini
- SHARK-Cut® Standard
- SHARK-Cut® Rebore
- Inserti
 - Descrizione delle Geometrie
 - Descrizione delle Qualità
- Ricambi
- Parametri di taglio
- Suggerimenti tecnici

168 – 169
170
171
172
173 – 175
176 – 177
178 – 182
178
179 – 180
183 – 184
185 – 192
193 – 198

ARNO Multifunktionswerkzeug SHARK-Cut®

ARNO Multi purpose tool SHARK-Cut®

ARNO Utensile multifunzione SHARK-Cut®

Vorteile des SHARK-CUT®-Systems:

DREHEN und BOHREN mit nur 1 Werkzeug!

Advantages of the Shark-Cut® system:

Turning and boring with only 1 tool!

Vantaggi del sistema SHARK-Cut®:

Foratura e barenatura con un unico utensile!

- Erzeugt ebenen Bohrungsgrund
- Problemlöser bei fehlenden Werkzeugplätzen an der Maschine
- Weniger Programmieraufwand
- Kürzere Rüstzeiten
- Reduzierte Voreinstellzeiten
- Reduzierte Lagerhaltung von Werkzeugen und Wendschneidplatten
- Geringere Kosten für die Werkzeugbeschaffung
- Produces a flat bottom hole
- Problem solver for insufficient machine tool posts
- Less programming
- Shorter set-up times
- Reduced pre-setting times
- Reduced stock-keeping costs for tools and indexable inserts
- Lower tool purchasing costs
- Foratura con fondo piano
- Risolutore di problemi nei casi di limitate posizioni utensili
- Riduce la programmazione macchina
- Riduce i tempi di setup utensili
- Riduce i tempi di setup
- Riduce i costi di magazzino di utensili ed inserti
- Riduce i costi di utensileria

4

SHARK-CUT® Mini:

DREHEN und BOHREN $\geq \varnothing 4 \text{ mm}$

Vollhartmetallwerkzeug

Turning and boring $\geq \varnothing 4 \text{ mm}$

Solid carbide tool

Foratura e barenatura $\geq \varnothing 4 \text{ mm}$

Utensile in metallo duro integrale

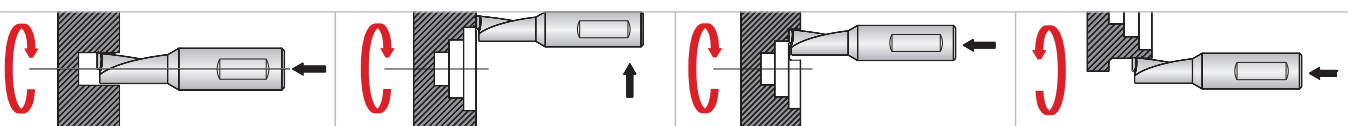

Bohren ins Volle mit ebenem Bohrungsgrund
Drilling with flat bottom face
Foratura con fondo piano

Drehen von Plankonturen
Facing operations
Sfacciatura

Drehen von Innenkonturen
Turning of internal profiles
Tornitura interna con ap ad inserto pieno

Drehen von Außenkonturen
Turning of external profiles
Tornitura esterna

SHARK-CUT® Standard:**DREHEN und BOHREN $\geq \varnothing 8$ mm***Turning and boring $\geq \varnothing 8$ mm*Foratura e barenatura $\geq \varnothing 8$ mm

1,5 x D

2,25 x D

3 x D

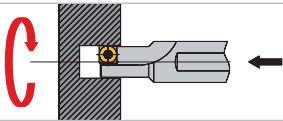
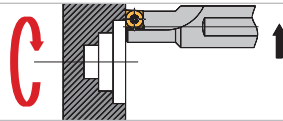
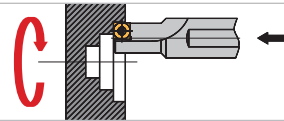
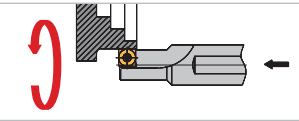
**Bohren ins Volle mit ebenem Bohrungsgrund***Drilling with flat bottom face*
Foratura con fondo piano**Drehen von Plankonturen**
Facing operations
Sfacciatura**Drehen von Innenkonturen**
Turning of internal profiles
Tornitura interna con ap ad inserto pieno**Drehen von Außenkonturen**
Turning of external profiles
Tornitura esterna**SHARK-CUT® Rebore:****2-schneidig $\geq \varnothing 12$ mm***2 flute $\geq \varnothing 12$ mm*2 taglienti $\geq \varnothing 12$ mm

2,25 x D

3-schneidig $\geq \varnothing 24$ mm*3 flute $\geq \varnothing 24$ mm*3 taglienti $\geq \varnothing 24$ mm

2,25 x D

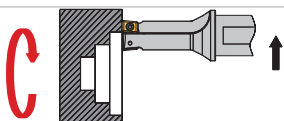
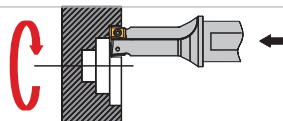
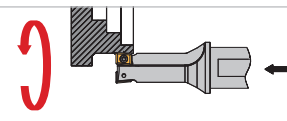
**Drehen von Plankonturen**
Facing operations
Sfacciatura**Drehen von Innenkonturen**
Turning of internal profiles
Tornitura interna con ap ad inserto pieno**Drehen von Außenkonturen**
Turning of external profiles
Tornitura esterna

SHARK-CUT® Mini

SC SHARK-CUT®	04 Nenn- durchmesser Diameter Diametro	R/L Rechts / Links Right / Left Destro / Sinistro	016 Nutzlänge max. depth Utile foratura	SP Gedrahter Spanraum Spiral flute Scarichi elicoidali	ALU Geometrie Geometry Geometria	AK10 Sorte Grade Grado
-------------------------	---	---	---	---	--	--

SHARK-CUT® Standard

SC SHARK-CUT®	16 Nenn- durchmesser Diameter Diametro	R/L Rechts / Links Right / Left Destro / Sinistro	0036 Nutzlänge max. depth Utile foratura	SP Gedrahter Spanraum Spiral flute Scarichi elicoidali	08 WSP-Größe Insert size Inserto lunghezza tagliente
-------------------------	---	---	--	---	---

SHARK-CUT® Rebore

SC SHARK-CUT®	24 Nenn- durchmesser Diameter Diametro	12 D min min. hole D preforo min	R Rechts schneidend Right hand cutting Taglio Destro	03 Anzahl der Schneiden N° of flutes N° tagliente	0054 Nutzlänge max. depth Utile foratura	G Spanraum gerade Straight flute Scarichi dritti	06 WSP-Größe Insert size Inserto lunghezza tagliente
-------------------------	---	--	--	--	--	--	---

SHARK-CUT® Wendeschneidplatten / Inserts / Inserti

LPET 080304FN WSP-Bezeichnung gemäß ISO-Norm ISO code Codifica ISO	AWI Geometrie Geometry Geometria	AL10 Sorte Grade Grado
--	--	--

4



SHARK-CUT® **Mini**

2,25 x D	Ø 4,0 – 8,0 mm	172
4 x D	Ø 4,0 – 8,0 mm	172



SHARK-CUT® **Standard**

1,5 x D	Ø 8,0 – 32,0 mm	173
2,25 x D	Ø 8,0 – 32,0 mm	174
3 x D	Ø 8,0 – 32,0 mm	175
	Densimet	



SHARK-CUT® **Rebore**

2-schneidig / 2 flute / 2 taglienti		
2,25 x D	Ø 12,0 – 50,0 mm	176
3-schneidig / 3 flute / 3 taglienti		
2,25 x D	Ø 24,0 – 50,0 mm	177



SHARK-CUT® **Wendeschneidplatten**

Inserts
Inserti

LPET	181
LPNT	182

Solid carbide cutter
Utensile in Metallo Duro

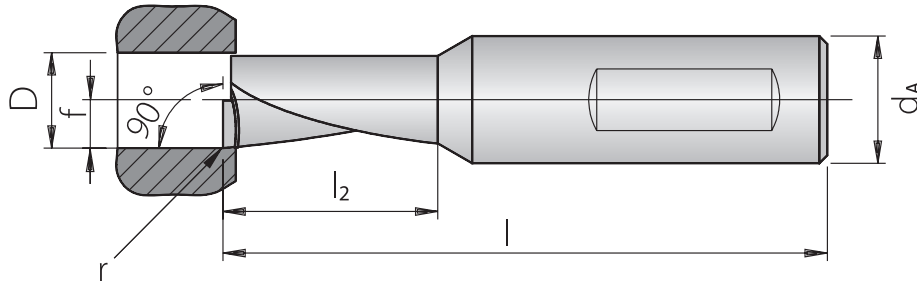

Schneideinsatz / Insert / Inserto

Rechte Ausführung abgebildet
Right-hand execution shown
Versione Destra in figura

Bezeichnung Designation Articolo	D	l	l ₂	d _A	f	r	beschichtet coated rivestito		unbeschichtet uncoated non rivestito	
							AL350	AM35C	AK10	AP40
SC04R/L-009SP	4	35	9,00	6	2,0	0,2	●			
SC04R/L-009SP-ALU	4	35	9,00	6	2,0	0,2			●	
SC04R/L-016SP	4	41	16,00	6	2,0	0,2	●			
SC04R/L-016SP-ALU	4	41	16,00	6	2,0	0,2			●	
SC05R/L-011SP	5	37	11,25	6	2,5	0,2	●			
SC05R/L-011SP-ALU	5	37	11,25	6	2,5	0,2			●	
SC05R/L-020SP	5	45	20,00	6	2,5	0,2	●			
SC05R/L-020SP-ALU	5	45	20,00	6	2,5	0,2			●	
SC06R/L-013SP	6	38	13,50	8	3,0	0,2	●			
SC06R/L-013SP-ALU	6	38	13,50	8	3,0	0,2			●	
SC06R/L-024SP	6	49	24,00	8	3,0	0,2	●			
SC06R/L-024SP-ALU	6	49	24,00	8	3,0	0,2			●	
SC07R/L-015SP	7	42	15,75	8	3,5	0,2	●			
SC07R/L-015SP-ALU	7	42	15,75	8	3,5	0,2			●	
SC07R/L-028SP	7	53	28,00	8	3,5	0,2	●			
SC07R/L-028SP-ALU	7	53	28,00	8	3,5	0,2			●	
SC08R/L-018SP	8	45	18,00	8	4,0	0,2	●			
SC08R/L-018SP-ALU	8	45	18,00	8	4,0	0,2			●	
SC08R/L-032SP	8	57	32,00	8	4,0	0,2	●			
SC08R/L-032SP-ALU	8	57	32,00	8	4,0	0,2			●	

4

Adapter / Holder / Adattatore

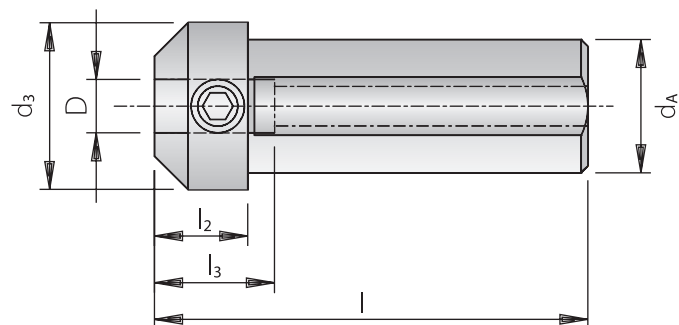

Trägerwerkzeug / Holder / Utensile

Bezeichnung Designation Articolo	D	d ₃	l	l ₂	l ₃	d _A	Klemmschraube Clambingscrew Vite
SC AD20-06	6	25	65	14	18	20	7897990
SC AD20-08	8	25	65	14	18	20	7897990

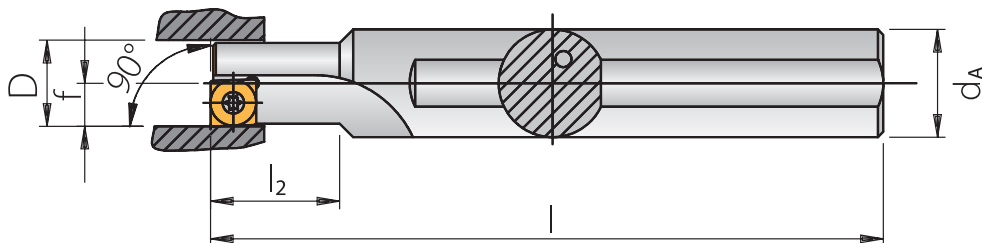
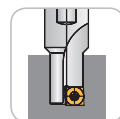
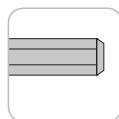

Rechte Ausführung abgebildet

Right-hand execution shown

Versione Destra in figura

Trägerwerkzeug / Holder / Utensile

Bezeichnung Designation Articolo	D	l	l ₂	d _A	f	Wendeschneidplatte Insert Inserto
SC08R/L-0012G-04*	8	80	12,0	12	4,0	LPET / LPNT 0401..
SC10R/L-0015G-05	10	90	15,0	12	5,0	LPET / LPNT 0502..
SC12R/L-0018G-06	12	100	18,0	16	6,0	LPET / LPNT 0602..
SC14R/L-0021G-07	14	110	21,0	16	7,0	LPET / LPNT 0703..
SC16R/L-0024G-08	16	125	24,0	20	8,0	LPET / LPNT 0803..
SC18R/L-0027G-09	18	135	27,0	25	9,0	LPET / LPNT 09T3..
SC20R/L-0030G-10	20	150	30,0	25	10,0	LPET / LPNT 10T3..
SC25R/L-0038G-13	25	180	37,5	32	12,5	LPET / LPNT 1304..
SC32R/L-0048G-17	32	200	48,0	40	16,0	LPET / LPNT 1705..

* Rechter Halter → Rechte Wendeschneidplatte

Linker Halter → Linke Wendeschneidplatte

* Right-hand holder → Right-hand indexable insert

Left-hand holder → Left-hand indexable insert

* Utensile Destro → Inserto Destro

Utensile Sinistro → Inserto Sinistro

HINWEIS:

Trägerwerkzeuge werden mit Klemmschrauben und Ersatzschrauben geliefert, jedoch ohne Schlüssel.

Ersatzteile und Zubehör siehe Seite 183.

INFORMATION: Holders will be supplied with clamping screws and spare screws, however without key. Spare parts and accessories see page 183.

NOTA:

L'utensile é fornito completo di vite, 1 vite di ricambio, ma SENZA chiave. Ricambi a pagina 183.

Drilling depth up to 2.25 x D
Foratura fino a 2,25 x D

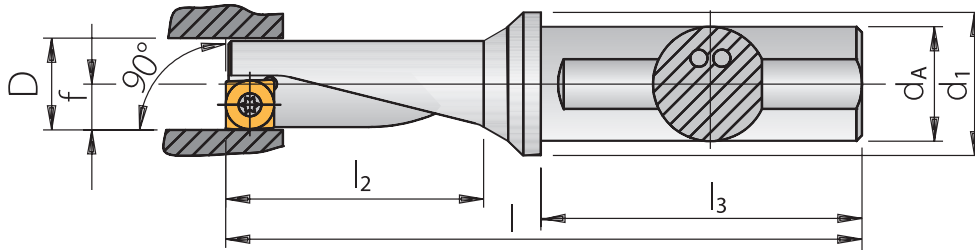
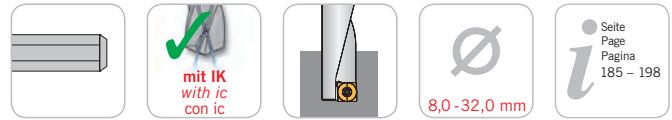

2,25
xD

Trägerwerkzeug / Holder / Utensile

Rechte Ausführung abgebildet
Right-hand execution shown
Versione Destra in figura

Bezeichnung Designation Articolo	D	l	l ₂	l ₃	d ₁	d _A	f	Wendeschneidplatte Insert Inserto
SC08R/L-0018SP-04*	8	60,0	18,0	38	12	10	4,0	LPET / LPNT 0401..
SC10R/L-0023SP-05	10	69,5	22,5	42	16	12	5,0	LPET / LPNT 0502..
SC12R/L-0027SP-06	12	78,0	27,0	45	20	16	6,0	LPET / LPNT 0602..
SC14R/L-0032SP-07	14	83,5	31,5	45	20	16	7,0	LPET / LPNT 0703..
SC16R/L-0036SP-08	16	94,0	36,0	50	25	20	8,0	LPET / LPNT 0803..
SC18R/L-0041SP-09	18	109,5	40,5	56	32	25	9,0	LPET / LPNT 09T3..
SC20R/L-0045SP-10	20	111,0	45,0	56	32	25	10,0	LPET / LPNT 10T3..
SC25R/L-0057SP-13	25	129,0	56,5	60	40	32	12,5	LPET / LPNT 1304..
SC32R/L-0072SP-17	32	158,0	72,0	70	50	40	16,0	LPET / LPNT 1705..

* Rechter Halter → Rechte Wendeschneidplatte
Linker Halter → Linke Wendeschneidplatte

* Right-hand holder → Right-hand indexable insert
Left-hand holder → Left-hand indexable insert

* Utensile Destro → Inserto Destro
Utensile Sinistro → Inserto Sinistro

HINWEIS: Trägerwerkzeuge werden mit Klemmschrauben und Ersatzschrauben geliefert, jedoch ohne Schlüssel.
Ersatzteile und Zubehör siehe Seite 183.

INFORMATION: Holders will be supplied with clamping screws and spare screws, however without key. Spare parts and accessories see page 183.

NOTA: L'utensile é fornito completo di vite, 1 vite di ricambio, ma SENZA chiave. Ricambi a pagina 183.

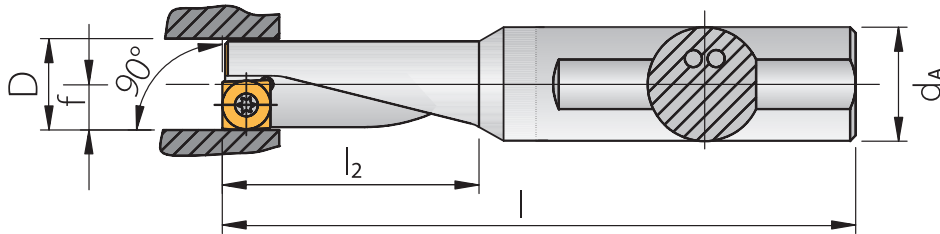
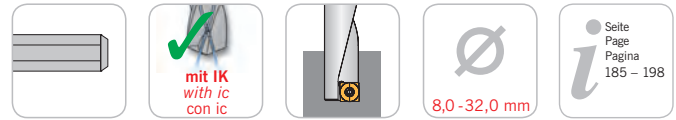

Schwingungsarm!
Vibration damped!
Stop alle vibrazioni!



Trägerwerkzeug / Holder / Utensile

Rechte Ausführung abgebildet
Right-hand execution shown
Versione Destra in figura

Bezeichnung Designation Articolo	D	l	l ₂	d _A	f	Wendeschneidplatte Insert Inserto
SC08R/L-0024SP-04*	8	80	24	12	4,0	LPET / LPNT 0401..
SC10R/L-0030SP-05	10	85	30	12	5,0	LPET / LPNT 0502..
SC12R/L-0036SP-06	12	95	36	16	6,0	LPET / LPNT 0602..
SC14R/L-0042SP-07	14	100	42	16	7,0	LPET / LPNT 0703..
SC16R/L-0048SP-08	16	110	48	20	8,0	LPET / LPNT 0803..
SC18R/L-0054SP-09	18	125	54	25	9,0	LPET / LPNT 09T3..
SC20R/L-0060SP-10	20	130	60	25	10,0	LPET / LPNT 10T3..
SC25R/L-0075SP-13	25	150	75	32	12,5	LPET / LPNT 1304..
SC32R/L-0096SP-17	32	185	96	40	16,0	LPET / LPNT 1705..

* Rechter Halter → Rechte Wendeschneidplatte
Linker Halter → Linke Wendeschneidplatte

* Right-hand holder → Right-hand indexable insert
Left-hand holder → Left-hand indexable insert

* Utensile Destro → Inserto Destro
Utensile Sinistro → Inserto Sinistro

HINWEIS: Trägerwerkzeuge werden mit Klemmschrauben und Ersatzschrauben geliefert, jedoch ohne Schlüssel.
Ersatzteile und Zubehör siehe Seite 183.

INFORMATION: Holders will be supplied with clamping screws and spare screws, however without key. Spare parts and accessories see page 183.

NOTA: L'utensile é fornito completo di vite, 1 vite di ricambio, ma SENZA chiave. Ricambi a pagina 183.

Drilling depth up to 2.25 x D – 2 flute
Foratura fino a 2,25 x D – 2 taglienti

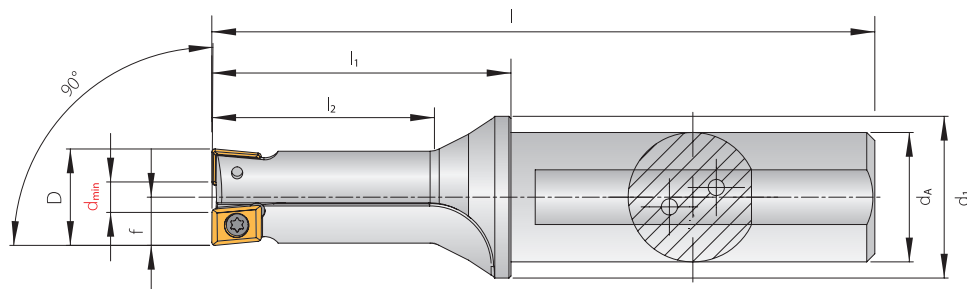

Trägerwerkzeug / Holder / Utensile

Rechte Ausführung abgebildet
Right-hand execution shown
Versione Destra in figura

Bezeichnung Designation Articolo	D	d _{min}	l	l ₁	l ₂	d ₁	d _A	f	z	Wendeschneidplatte Insert Inserto
SCR1204R02-0027G-04*	12,0	4,0	82	37	27	20	16	5,0	2	LPET / LPNT 0401..
SCR1305R02-0029G-04*	13,0	5,0	84	39	29	20	16	6,0	2	LPET / LPNT 0401..
SCR1406R02-0032G-04*	14,0	6,0	86	41	32	20	16	7,0	2	LPET / LPNT 0401..
SCR1507R02-0034G-04*	15,0	7,0	88	43	34	20	16	8,0	2	LPET / LPNT 0401..
SCR1606R02-0036G-05	16,0	6,0	97	47	36	25	20	7,0	2	LPET / LPNT 0502..
SCR1707R02-0038G-05	17,0	7,0	99	49	38	25	20	8,0	2	LPET / LPNT 0502..
SCR17575R02-0039G-05	17,5	7,5	101	51	39	25	20	8,5	2	LPET / LPNT 0502..
SCR1806R02-0041G-06	18,0	6,0	102	52	41	25	20	7,0	2	LPET / LPNT 0602..
SCR1907R02-0043G-06	19,0	7,0	104	54	43	25	20	8,0	2	LPET / LPNT 0602..
SCR2006R02-0045G-07	20,0	6,0	114	58	45	32	25	7,0	2	LPET / LPNT 0703..
SCR2107R02-0047G-07	21,0	7,0	116	60	47	32	25	8,0	2	LPET / LPNT 0703..
SCR2208R02-0050G-07	22,0	8,0	118	62	50	32	25	9,0	2	LPET / LPNT 0703..
SCR2309R02-0052G-07	23,0	9,0	120	64	52	32	25	10,0	2	LPET / LPNT 0703..
SCR2408R02-0054G-08	24,0	8,0	122	66	54	32	25	9,0	2	LPET / LPNT 0803..
SCR2509R02-0056G-08	25,0	9,0	130	70	56	40	32	10,0	2	LPET / LPNT 0803..
SCR2608R02-0059G-09	26,0	8,0	134	74	59	40	32	9,0	2	LPET / LPNT 09T3..
SCR2709R02-0061G-09	27,0	9,0	137	77	61	40	32	10,0	2	LPET / LPNT 09T3..
SCR2810R02-0063G-09	28,0	10,0	140	80	63	40	32	11,0	2	LPET / LPNT 09T3..
SCR2909R02-0065G-10	29,0	9,0	144	84	65	40	32	10,0	2	LPET / LPNT 10T3..
SCR3010R02-0068G-10	30,0	10,0	146	86	68	40	32	11,0	2	LPET / LPNT 10T3..
SCR3111R02-0070G-10	31,0	11,0	149	89	70	40	32	12,0	2	LPET / LPNT 10T3..
SCR3212R02-0072G-10	32,0	12,0	151	91	72	40	32	13,0	2	LPET / LPNT 10T3..
SCR3313R02-0074G-10	33,0	13,0	154	94	75	40	32	13,0	2	LPET / LPNT 10T3..
SCR3414R02-0077G-10	34,0	14,0	156	96	77	40	32	15,0	2	LPET / LPNT 1304..
SCR3510R02-0079G-13	35,0	10,0	166	96	79	50	40	10,0	2	LPET / LPNT 1304..
SCR3611R02-0081G-13	36,0	11,0	168	98	81	50	40	11,0	2	LPET / LPNT 1304..
SCR3712R02-0083G-13	37,0	12,0	170	100	83	50	40	12,0	2	LPET / LPNT 1304..
SCR3813R02-0086G-13	38,0	13,0	173	103	86	50	40	13,0	2	LPET / LPNT 1304..
SCR3914R02-0088G-13	39,0	14,0	175	105	88	50	40	14,0	2	LPET / LPNT 1304..
SCR4015R02-0090G-13	40,0	15,0	177	107	90	50	40	15,0	2	LPET / LPNT 1304..
SCR4116R02-0092G-13	41,0	16,0	179	109	92	50	40	16,0	2	LPET / LPNT 1304..
SCR4217R02-0095G-13	42,0	17,0	182	112	95	50	40	17,0	2	LPET / LPNT 1304..
SCR4318R02-0097G-13	43,0	18,0	185	115	97	50	40	18,0	2	LPET / LPNT 1304..
SCR4419R02-0099G-13	44,0	19,0	187	117	99	50	40	19,0	2	LPET / LPNT 1304..
SCR4513R02-0101G-17	45,0	13,0	192	122	101	55	40	13,0	2	LPET / LPNT 1705..
SCR4614R02-0104G-17	46,0	14,0	194	124	104	55	40	14,0	2	LPET / LPNT 1705..
SCR4715R02-0106G-17	47,0	15,0	196	126	106	55	40	15,0	2	LPET / LPNT 1705..
SCR4816R02-0108G-17	48,0	16,0	198	128	108	55	40	16,0	2	LPET / LPNT 1705..
SCR4917R02-0110G-17	49,0	17,0	200	130	110	55	40	17,0	2	LPET / LPNT 1705..
SCR5018R02-0113G-17	50,0	18,0	203	133	113	55	40	18,0	2	LPET / LPNT 1705..

* Rechter Halter → Rechte Wendeschneidplatte
* Right-hand holder → Right-hand indexable insert
* Utensile Destro → Inserto Destro

HINWEIS: Trägerwerkzeuge werden mit Klemmschrauben und Ersatzschrauben geliefert, jedoch ohne Schlüssel. Ersatzteile und Zubehör siehe Seite 183.

INFORMATION: Holders will be supplied with clamping screws and spare screws, however without key. Spare parts and accessories see page 183.

NOTA: L'utensile é fornito completo di vite, 1 vite di ricambio, ma SENZA chiave. Ricambi a pagina 183.

Drilling depth up to 2.25 x D – 3 flute
Foratura fino a 2,25 x D – 3 taglienti

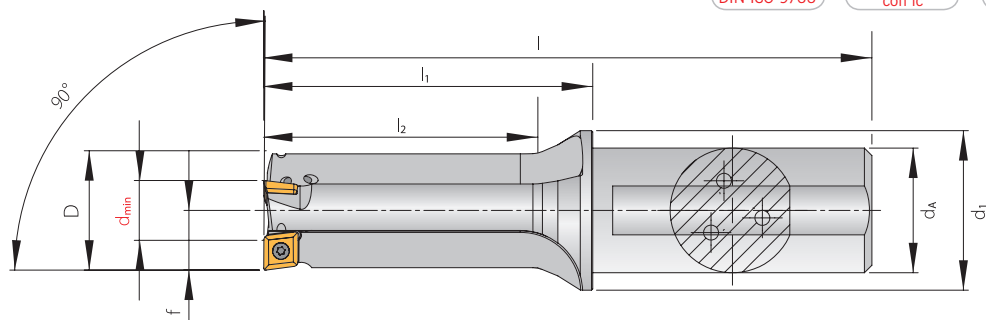
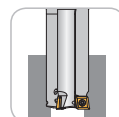

Trägerwerkzeug / Holder / Utensile

Rechte Ausführung abgebildet
Right-hand execution shown
Versione Destra in figura

Bezeichnung Designation Articolo	D	d _{min}	l	l ₁	l ₂	d ₁	d _A	f	z	Wendeschneidplatte Insert Inserto
SCR2412R03-0054G-06	24	12	122	66	54	32	25	13	3	LPET / LPNT 0602..
SCR2513R03-0056G-06	25	13	130	70	56	40	32	14	3	LPET / LPNT 0602..
SCR2612R03-0059G-07	26	12	134	74	59	40	32	13	3	LPET / LPNT 0703..
SCR2713R03-0061G-07	27	13	137	77	61	40	32	14	3	LPET / LPNT 0703..
SCR2814R03-0063G-07	28	14	140	80	63	40	32	15	3	LPET / LPNT 0703..
SCR2913R03-0065G-08	29	13	144	84	65	40	32	14	3	LPET / LPNT 0803..
SCR3014R03-0068G-08	30	14	146	86	68	40	32	15	3	LPET / LPNT 0803..
SCR3115R03-0070G-08	31	15	149	89	70	40	32	16	3	LPET / LPNT 0803..
SCR3216R03-0072G-08	32	16	151	91	72	40	32	17	3	LPET / LPNT 0803..
SCR3317R03-0074G-08	33	17	154	94	74	40	32	18	3	LPET / LPNT 0803..
SCR3418R03-0077G-08	34	18	156	96	77	40	32	19	3	LPET / LPNT 0803..
SCR3517R03-0079G-09	35	17	166	96	79	50	40	18	3	LPET / LPNT 09T3..
SCR3618R03-0081G-09	36	18	168	98	81	50	40	19	3	LPET / LPNT 09T3..
SCR3719R03-0083G-09	37	19	170	100	83	50	40	20	3	LPET / LPNT 09T3..
SCR3820R03-0086G-09	38	20	173	103	86	50	40	21	3	LPET / LPNT 09T3..
SCR3921R03-0088G-09	39	21	175	105	88	50	40	22	3	LPET / LPNT 09T3..
SCR4022R03-0090G-09	40	22	177	107	90	50	40	23	3	LPET / LPNT 09T3..
SCR4121R03-0092G-10	41	21	179	109	92	50	40	22	3	LPET / LPNT 10T3..
SCR4222R03-0095G-10	42	22	182	112	95	50	40	23	3	LPET / LPNT 10T3..
SCR4323R03-0097G-10	43	23	185	115	97	50	40	24	3	LPET / LPNT 10T3..
SCR4424R03-0099G-10	44	24	187	117	99	50	40	25	3	LPET / LPNT 10T3..
SCR4525R03-0101G-10	45	25	190	120	101	50	40	26	3	LPET / LPNT 10T3..
SCR4626R03-0104G-10	46	26	192	122	104	50	40	27	3	LPET / LPNT 10T3..
SCR4727R03-0106G-10	47	27	195	125	106	50	40	28	3	LPET / LPNT 10T3..
SCR4823R03-0108G-13	48	23	198	128	108	55	40	23	3	LPET / LPNT 1304..
SCR4924R03-0110G-13	49	24	200	130	110	55	40	24	3	LPET / LPNT 1304..
SCR5025R03-0113G-13	50	25	203	133	113	55	40	25	3	LPET / LPNT 1304..

HINWEIS: Trägerwerkzeuge werden mit Klemmschrauben und Ersatzschrauben geliefert, jedoch ohne Schlüssel.
Ersatzteile und Zubehör siehe Seite 184.

INFORMATION: Holders will be supplied with clamping screws and spare screws, however without key. Spare parts and accessories see page 184.

NOTA: L'utensile é fornito completo di vite, 1 vite di ricambio, ma SENZA chiave. Ricambi a pagina 184.

- ALU

- Hochglänzende, polierte Oberfläche der Wendeschneidplatte für minimale Verklebung und optimales Zerspanungsverhalten
- Hochpositive Schneidengeometrie
- Spezielle Geometrie für die Bearbeitung von Aluminiumwerkstoffen, NE-Metallen und Kunststoffen



- ALU

- *Ground and polished insert surface for minimum friction and optimum cutting performance*
- *Highpositive geometry*
- *Special geometry for machining aluminium, non-ferrous materials and synthetics*

- ALU

- Geometria lappata per un ottimo taglio del materiale e per ridurre incollaggi sulla superficie
- Geometria con spoglia superiore molto positiva
- Geometria dedicata alla lavorazione di materiali non ferrosi, ghise e plastiche

- EN/ER/EL

- Standardgeometrie für die Bearbeitung von Stahl, Guss und rostfreiem Stahl



- EN/ER/EL

- *Standard geometry for machining steel, stainless steel and cast iron*

- EN/ER/EL

- Geometria Standard per la lavorazione di acciai, acciai inossidabili e ghise acciai

- WI/AWI

- Extrem hochwertige Oberflächen durch Schleppschnide
- Breitschichtgeometrie
- Erhöhter Vorschub für optimalen Spanbruch, geringere Bearbeitungszeiten und somit höhere Wirtschaftlichkeit



- WI/AWI

- *Extremely good surface finish with wiper geometry*
- *Wiper edge geometry*
- *Increased feed rate for better chip breaking, reduced machine time and therefore better productivity*

- WI/AWI

- Geometria con tecnologia wiper per ottime finiture superficiali
- Grazie al raschiante è possibile incrementare avanzamenti e ridurre tempi ciclo
- Geometria raschiante con tecnologia wiper su inserto -ALU per una migliorata finitura superficiale di leghe non ferrose, alluminio e plastiche

Hartmetall beschichtet / Carbide grade coated / Metallo duro rivestito**AK2015** Erste Wahl für die **Bearbeitung von Gusswerkstoffen.***First choice for machining cast materials.*

Qualità per la lavorazione di materiali non ferrosi, ghise e plastiche.

AM35C Erste Wahl für die **Bearbeitung von Stahl.***First choice for machining steel.*

Qualità per la lavorazione di acciai generici.

AM5035 Erste Wahl für die **Bearbeitung rostfreier Stähle.***First choice for machining stainless steel.*

Qualità per la lavorazione di acciai inossidabili.

AM5035 (AL350) – HC - P40, HC - M35PVD-Mehrlagenbeschichtung,
Substrat + TiAlN

Hartmetallsorte für die Bearbeitung von rostfreien Stählen. Sorte ist auch zum Bearbeiten von Stahlwerkstoffen im niedrigen bis mittleren Festigkeitsbereich, sowie hochwarmfester Legierungen geeignet. Optimale Schneidkantenstabilität. Auch im mittleren und niedrigen Schnittgeschwindigkeitsbereich sehr gute Ergebnisse.

*PVD-multilayer coating,
substrate + TiAlN**Grade for machining stainless steel, but can also be used for steel materials with low to medium hardness as well as high temperature alloys. Optimum cutting edge stability. Excellent results at low to medium cutting speeds.*Rivestimento multistrato PVD,
substrato + TiAlN

Qualità di metallo duro per lavorazione di acciaio inossidabile, anche idonea per acciai con durezza medio-bassa e per leghe altamente legate. Ottima stabilità tagliente. Eccellenti risultati a velocità di taglio medio basse.

AK2015 – HC - P15, HC - K15 - CVD

CVD-Mehrlagenbeschichtung,

Substrat + TiCN + TiCN + TiCNB + Al₂O₃

Das Hauptanwendungsgebiet dieser Sorte ist die Bearbeitung von Gusswerkstoffen aller Art. Sie eignet sich aber auch zum Bearbeiten von Stahlwerkstoffen. Das neue Substrat gewährleistet die erforderliche Zähigkeit und Warmfestigkeit.

*CVD-multilayer coating,**substrate + TiCN + TiCN + TiCNB + Al₂O₃**The main application area for this grade is the machining of all cast materials. It is also suitable for machining steel. The new substrate offers the necessary toughness and heat resistance.*

Rivestimento multistrato CVD,

substrato + TiCN + TiCN + TiCNB + Al₂O₃

Grado studiato per lavorare materiali teneri stampati o da fusione. In alcune applicazioni idoneo anche alla lavorazione di acciai. Lo speciale substrato offre il giusto compromesso tra tenacità e resistenza all'usura.

AL10 – HC - P10, HC - M15, HC - K10, HC - N15, HC - S10

PVD-Mehrlagenbeschichtung,

Substrat + AlTiN

Extrem verschleißfeste Sorte zur Bearbeitung von Stählen und Grauguss. Diese Sorte zeichnet sich durch hohe Beschichtungshärte und äußerst hohe Verschleißfestigkeit aus. Besonders geeignet für sehr hohe Schnittgeschwindigkeiten.

*PVD-multilayer coating,**substrate + AlTiN**Extremely wear resistant grade for machining steel materials, cast iron and non-ferrous products. Due to high hardness in coating, high wear-resistance can be achieved. Specially suitable for high cutting speeds.*

Rivestimento multistrato PVD,

substrato + AlTiN

Grado dall'elevata resistente all'usura per la lavorazione di acciai, ghise e materiali non ferrosi. Il rivestimento di elevata durezza assicura un'ottima resistenza all'usura. Valido per elevate velocità di taglio.

AM35C – HC - P35, HC - M30

CVD-Mehrlagenbeschichtung,

Substrat + TiC + TiCN + TiN

Hartmetallsorte mit hoher Zähigkeit für die Stahlbearbeitung im mittleren Schnittgeschwindigkeitsbereich.

*CVD-multilayer coating,**substrate + TiC + TiCN + TiN**Carbide grade with high toughness for machining steel materials at medium cutting speeds.*

Rivestimento multistrato CVD,

substrato + TiC + TiCN + TiN

Grado di metallo duro universale per la lavorazione di acciai a medie velocità di taglio.

AR26C – HC - P25, HC - K20

CVD-Mehrlagenbeschichtung,

Substrat + TiN + TiCN + Al₂O₃

Hartmetallsorte mit hoher Verschleißfestigkeit für die Bearbeitung von Guss- und Stahlwerkstoffen.

*CVD-multilayer coating,**substrate + TiN + TiCN + Al₂O₃**Carbide grade with high wear-resistance for machining cast iron and steel materials.*

Rivestimento multistrato CVD,

substrato + TiC + TiCN + Al₂O₃

Qualità di metallo duro con alta resistenza all'usura per la lavorazione di ghise ed alcuni acciai teneri debolmente legati o dal basso tenore di carbonio.

Grade description
Descrizione delle Qualità

Hartmetall unbeschichtet / Carbide grade uncoated / Metallo duro non rivestito

AK10 – HW - K10, HW - N10, HW - S10

Hartmetallsorte für die Bearbeitung von Aluminium, Aluminiumlegierungen, Nichteisenmetallen und Kunststoffen. Die Sorte ist auch bedingt geeignet für die Bearbeitung von Gusswerkstoffen, Titan und Titanlegierungen. Die Wendeschneidplatte ist umfangsseitig geschliffen und die Spanfläche poliert.

*Grade for machining aluminium, aluminium alloys, non-ferrous metals and plastics.
Grade can also be used for machining cast iron and temperature metals. Insert is periphery-ground and the chipbreaker is polished.*

Metallo duro micrograna per la lavorazione di alluminio, leghe di alluminio, metalli non ferrosi e leghe plastiche. Valido anche in determinate condizioni di stabilità per la finitura di ghisa e leghe altamente legate. Gli inserti sono lappati sulla superficie e rettificati sul perimetro.

AP40 – HW - P40, HW - M35

Speziell für die Stahlbearbeitung bei Schnittgeschwindigkeiten unter 80 m/min oder bei ungünstigen Stabilitätsverhältnissen.

Special carbide grade for steel materials at cutting speeds below 80 m/min and unstable machining conditions.

Grado di metallo duro tenace per lavorare acciai a velocità di taglio inferiori agli 80 m/min ed in condizioni instabili di lavoro.

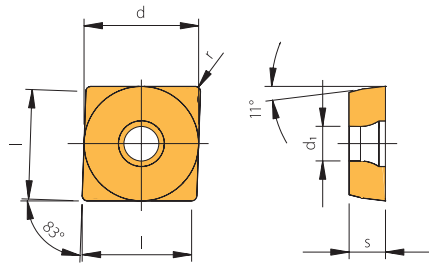

LPET



Bezeichnung Designation Articolo	l	d ^o	s	r	d ₁	beschichtet coated rivestito			unbeschichtet uncoated non rivestito
						AL10	AM35C	AR26C	AK10
LPET 050204FN-ALU	5,0	5,8	2,10	0,4	2,25	●			●
LPET 060204FN-ALU	6,0	6,5	2,38	0,4	2,50	●			●
LPET 070304FN-ALU	7,0	7,6	3,18	0,4	2,80	●			●
LPET 080304FN-ALU	8,0	8,5	3,18	0,4	3,40	●			●
LPET 09T304FN-ALU	9,0	9,6	3,00	0,4	3,40	●			●
LPET 10T304FN-ALU	10,0	10,6	3,97	0,4	4,40	●			●
LPET 130404FN-ALU	12,5	13,5	4,76	0,4	5,30	●			●
LPET 170508FN-ALU	16,0	17,5	5,56	0,8	5,30	●			●
LPET 040102FL-AWI*	4,0	4,5	1,80	0,2	2,10	●			●
LPET 040102FR-AWI*	4,0	4,5	1,80	0,2	2,10	●			●
LPET 040104FL-AWI*	4,0	4,5	1,80	0,4	2,10	●			●
LPET 040104FR-AWI*	4,0	4,5	1,80	0,4	2,10	●			●
LPET 050202FN-AWI	5,0	5,8	2,10	0,2	2,25	●			●
LPET 050204FN-AWI	5,0	5,8	2,10	0,4	2,25	●			●
LPET 060202FN-AWI	6,0	6,5	2,38	0,2	2,50	●			●
LPET 060204FN-AWI	6,0	6,5	2,38	0,4	2,50	●			●
LPET 070304FN-AWI	7,0	7,6	3,18	0,4	2,80	●			●
LPET 080304FN-AWI	8,0	8,5	3,18	0,4	3,40	●			●
LPET 09T304FN-AWI	9,0	9,6	3,97	0,4	3,40	●			●
LPET 10T304FN-AWI	10,0	10,6	3,97	0,4	4,40	●			●
LPET 10T308FN-AWI	10,0	10,6	3,97	0,8	4,40	●			●
LPET 130404FN-AWI	12,5	13,5	4,76	0,4	5,30	●			●
LPET 130408FN-AWI	12,5	13,5	4,76	0,8	5,30	●			●
LPET 170508FN-AWI	16,0	17,5	5,56	0,8	5,30	●			●
LPET 060204EN-WI	6,0	6,5	2,38	0,4	2,5		●	●	
LPET 070304EN-WI	7,0	7,6	3,18	0,4	2,8		●	●	
LPET 080304EN-WI	8,0	8,5	3,18	0,4	3,4		●	●	
LPET 09T304EN-WI	9,0	9,6	3,97	0,4	3,4		●	●	
LPET 10T304EN-WI	10,0	10,6	3,97	0,4	4,4		●	●	
LPET 130404EN-WI	12,5	13,5	4,76	0,4	5,3		●	●	
LPET 170508EN-WI	16,0	17,5	5,56	0,8	5,3		●	●	

- * Rechter Halter → Rechte Wendeschneidplatte
- * Right-hand holder → Right-hand indexable insert
- * Utensile Destro → Inserto Destro

- Maß „d“ gemessen auf Höhe Maß „s“
- Dimension “d” measured to height “s”
- Dimensione “d” misurata ad altezza “s”

- Hauptanwendung
Main application
Applicazione principale
- Nebenanwendung
Secondary application
Applicazione secondaria

P	●	●	●	
M	●	○	●	
K	○		●	○
N				●
S	○	○		
H	○			

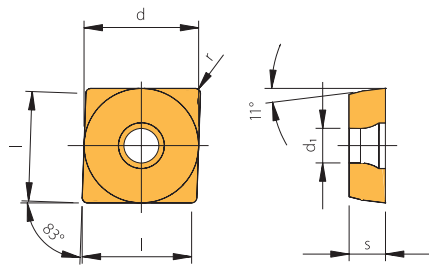

LPNT

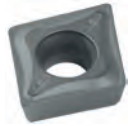

Bezeichnung Designation Articolo	l	d ^o	s	r	d ₁	beschichtet coated rivestito					unbeschichtet uncoated non rivestito
						AM5035	AK2015	AL350	AM35C	AR26C	AP40
LPNT 040102ER*	4,0	4,5	1,80	0,2	2,10			●	●	●	●
LPNT 040104ER*	4,0	4,5	1,80	0,4	2,10	●	●	●	●	●	●
LPNT 040102EL	4,0	4,5	1,80	0,2	2,10			●	●	●	●
LPNT 040104EL	4,0	4,5	1,80	0,4	2,10	●	●	●	●	●	●
LPNT 050202EN	5,0	5,8	2,10	0,2	2,25			●	●	●	●
LPNT 050204EN	5,0	5,8	2,10	0,4	2,25	●	●	●	●	●	●
LPNT 060202EN	6,0	6,5	2,38	0,2	2,50			●	●	●	●
LPNT 060204EN	6,0	6,5	2,38	0,4	2,50	●	●	●	●	●	●
LPNT 070304EN	7,0	7,6	3,18	0,4	2,80	●	●	●	●	●	●
LPNT 080304EN	8,0	8,5	3,18	0,4	3,40	●	●	●	●	●	●
LPNT 09T304EN	9,0	9,6	3,97	0,4	3,40	●	●	●	●	●	●
LPNT 10T304EN	10,0	10,6	3,97	0,4	4,40	●	●	●	●	●	●
LPNT 10T308EN	10,0	10,6	3,97	0,8	4,40			●	●	●	●
LPNT 130404EN	12,5	13,5	4,76	0,4	5,30	●	●	●	●	●	●
LPNT 130408EN	12,5	13,5	4,76	0,8	5,30			●	●	●	●
LPNT 170508EN	16,0	17,5	5,56	0,8	5,30	●	●	●	●	●	●

- * Rechter Halter → Rechte Wendeschneidplatte
- * Right-hand holder → Right-hand indexable insert
- * Utensile Destro → Inserto Destro

- Maß „d“ gemessen auf Höhe Maß „s“
- Dimension “d” measured to height “s”
- Dimensione “d” misurata ad altezza “s”

- Hauptanwendung
Main application
Applicazione principale
- Nebenanwendung
Secondary application
Applicazione secondaria

P	○	○	○	●	●	●
M	●		●	○	●	
K		●			●	
N						
S	○		○	○		
H						

SHARK-CUT® Standard

Halter Holder Utensile	Schraube Srew Vite	Anzugsmoment Torque Momento di serraggio	Schlüssel Key Chiave
SC08R/L- ..SP04	7815108	0,6 Nm	T 5106
SC10R/L- ..SP05	7815110	0,6 Nm	T 5106
SC12R/L- ..SP06	SS 5151	1,0 Nm	T 5107
SC14R/L- ..SP07	SS 1751	1,3 Nm	T 5108
SC16R/L- ..SP08	SS 8831	2,2 Nm	T 5108
SC18R/L- ..SP09	SS 8831	2,2 Nm	T 5108
SC20R/L- ..SP10	SS 2314	3,4 Nm	T 5115
SC25R/L- ..SP13	7822114	6,2 Nm	T 5120
SC32R/L- ..SP17	7822114	6,2 Nm	T 5120

SHARK-CUT® Rebore 2-schneidig / 2 flute / 2 taglianti

Halter Holder Utensile	Schraube Srew Vite	Anzugsmoment Torque Momento di serraggio	Schlüssel Key Chiave
SCR 1204 R02..	7815108	0,6 Nm	T 5106
SCR 1305 R02..	7815108	0,6 Nm	T 5106
SCR 1406 R02..	7815108	0,6 Nm	T 5106
SCR 1507 R02..	7815108	0,6 Nm	T 5106
SCR 1606 R02..	7815110	0,6 Nm	T 5106
SCR 1707 R02..	7815110	0,6 Nm	T 5106
SCR 17575 R02..	7815110	0,6 Nm	T 5106
SCR 1806 R02..	SS 5151	1,0 Nm	T 5107
SCR 1907 R02..	SS 5151	1,0 Nm	T 5107
SCR 2006 R02..	SS 1751	1,3 Nm	T 5108
SCR 2107 R02..	SS 1751	1,3 Nm	T 5108
SCR 2208 R02..	SS 1751	1,3 Nm	T 5108
SCR 2309 R02..	SS 1751	1,3 Nm	T 5108
SCR 2408 R02..	SS 8831	2,2 Nm	T 5108
SCR 2509 R02..	SS 8831	2,2 Nm	T 5108
SCR 2608 R02..	SS 8831	2,2 Nm	T 5108
SCR 2709 R02..	SS 8831	2,2 Nm	T 5108
SCR 2810 R02..	SS 8831	2,2 Nm	T 5108
SCR 2909 R02..	SS 2314	3,4 Nm	T 5115
SCR 3010 R02..	SS 2314	3,4 Nm	T 5115
SCR 3111 R02..	SS 2314	3,4 Nm	T 5115
SCR 3212 R02..	SS 2314	3,4 Nm	T 5115
SCR 3313 R02..	SS 2314	3,4 Nm	T 5115
SCR 3414 R02..	SS 2314	3,4 Nm	T 5115
SCR 3510 R02..	7822114	6,2 Nm	T 5120
SCR 3611 R02..	7822114	6,2 Nm	T 5120
SCR 3712 R02..	7822114	6,2 Nm	T 5120
SCR 3813 R02..	7822114	6,2 Nm	T 5120
SCR 3914 R02..	7822114	6,2 Nm	T 5120
SCR 4015 R02..	7822114	6,2 Nm	T 5120
SCR 4116 R02..	7822114	6,2 Nm	T 5120
SCR 4217 R02..	7822114	6,2 Nm	T 5120
SCR 4318 R02..	7822114	6,2 Nm	T 5120
SCR 4419 R02..	7822114	6,2 Nm	T 5120
SCR 4513 R02..	7822114	6,2 Nm	T 5120
SCR 4614 R02..	7822114	6,2 Nm	T 5120
SCR 4715 R02..	7822114	6,2 Nm	T 5120
SCR 4816 R02..	7822114	6,2 Nm	T 5120
SCR 4917 R02..	7822114	6,2 Nm	T 5120
SCR 5018 R02..	7822114	6,2 Nm	T 5120

HINWEIS: Drehmoment-Schraubendreher siehe Seite 281.

INFORMATION: For torque screw drivers see page 281.

NOTA: Chiavi dinamometriche a pagina 281.



SHARK-CUT® **Rebore 3-schneidig / 3 flute / 3 taglienti**

Halter Holder Utensile	Schraube Srew Vite	Anzugsmoment Torque Momento di serraggio	Schlüssel Key Chiave
SCR 2412 R03..	SS 5151	1,0 Nm	T 5107
SCR 2513 R03..	SS 5151	1,0 Nm	T 5107
SCR 2612 R03..	SS 1751	1,3 Nm	T 5108
SCR 2713 R03..	SS 1751	1,3 Nm	T 5108
SCR 2814 R03..	SS 1751	1,3 Nm	T 5108
SCR 2913 R03..	SS 8831	2,2 Nm	T 5108
SCR 3014 R03..	SS 8831	2,2 Nm	T 5108
SCR 3115 R03..	SS 8831	2,2 Nm	T 5108
SCR 3216 R03..	SS 8831	2,2 Nm	T 5108
SCR 3317 R03..	SS 8831	2,2 Nm	T 5108
SCR 3418 R03..	SS 8831	2,2 Nm	T 5108
SCR 3517 R03..	SS 8831	2,2 Nm	T 5108
SCR 3618 R03..	SS 8831	2,2 Nm	T 5108
SCR 3719 R03..	SS 8831	2,2 Nm	T 5108
SCR 3820 R03..	SS 8831	2,2 Nm	T 5108
SCR 3921 R03..	SS 8831	2,2 Nm	T 5108
SCR 4022 R03..	SS 8831	2,2 Nm	T 5108
SCR 4121 R03..	SS 2314	3,4 Nm	T 5115
SCR 4222 R03..	SS 2314	3,4 Nm	T 5115
SCR 4323 R03..	SS 2314	3,4 Nm	T 5115
SCR 4424 R03..	SS 2314	3,4 Nm	T 5115
SCR 4525 R03..	SS 2314	3,4 Nm	T 5115
SCR 4626 R03..	SS 2314	3,4 Nm	T 5115
SCR 4727 R03..	SS 2314	3,4 Nm	T 5115
SCR 4823 R03..	7822114	6,2 Nm	T 5120
SCR 4924 R03..	7822114	6,2 Nm	T 5120
SCR 5025 R03..	7822114	6,2 Nm	T 5120

HINWEIS: Drehmoment-Schraubendreher siehe Seite 281.

INFORMATION: For torque screw drivers see page 281.

NOTA: Chiavi dinamometriche a pagina 281.



ISO	Werkstoff	Zugfestigkeit [N/mm ²]	Schnittgeschwindigkeit V _c [m/min]								
			AM5035	AK2015	AL10	AL350	AM35C	AR26C	AK10	AP40	
P	Unlegierter Stahl und Stahlguss	ca. 0,15 % C, geglüht	340	120 - 230	120 - 220	200 - 300	120 - 230	140 - 250	150 - 280	-	80 - 140
		ca. 0,45 % C, geglüht	640	80 - 160	100 - 160	170 - 280	80 - 160	100 - 180	120 - 200	-	70 - 100
		ca. 0,45 % C, vergütet	830	80 - 160	100 - 160	160 - 250	80 - 160	100 - 180	120 - 200	-	70 - 100
		ca. 0,75 % C, geglüht	900	60 - 130	80 - 140	150 - 250	60 - 130	80 - 150	100 - 180	-	60 - 100
		ca. 0,75 % C, vergütet	1000	50 - 130	80 - 130	150 - 250	50 - 130	70 - 150	100 - 170	-	50 - 100
	Niedrig legierter Stahl und Stahlguss	geglüht	600	80 - 160	100 - 160	170 - 270	80 - 160	100 - 180	120 - 200	-	60 - 100
		vergütet	920	60 - 130	70 - 130	160 - 250	60 - 130	80 - 150	90 - 160	-	50 - 90
		vergütet	1000	60 - 120	60 - 130	150 - 250	60 - 120	80 - 150	80 - 160	-	50 - 80
		vergütet	1170	60 - 100	60 - 110	150 - 220	60 - 100	70 - 120	80 - 140	-	50 - 80
	Hochlegierter Stahl, hochlegierter Werkzeugstahl und Stahlguss	geglüht	670	80 - 140	90 - 140	-	80 - 140	100 - 160	110 - 180	-	60 - 80
gehärtet und angelassen		1100	50 - 100	60 - 110	-	50 - 100	60 - 120	80 - 140	-	-	
Nichtrostender Stahl und Stahlguss	ferritisch/martensitisch, geglüht	670	50 - 200	-	160 - 280	50 - 200	100 - 180	-	-	-	
	martensitisch, vergütet	1000	50 - 150	-	140 - 280	50 - 150	80 - 150	-	-	-	
M	Nichtrostender Stahl und Stahlguss	austenitisch und austenitisch/ferritisch, abgeschreckt	450 - 600	50 - 190	-	140 - 280	50 - 190	100 - 190	-	-	50 - 150
		600 - 900	50 - 100	-	-	50 - 100	-	-	-	-	40 - 90
K	Grauguss	perlitisch, ferritisch	500 - 700	-	140 - 240	170 - 300	-	-	120 - 200	100 - 150	-
		perlitisch, martensitisch	700 - 850	-	140 - 240	150 - 270	-	-	120 - 200	100 - 150	-
			800 - 1100	-	120 - 190	120 - 240	-	-	100 - 160	80 - 120	-
	Gusseisen mit Kugelgraphit	ferritisch	550	-	130 - 240	140 - 230	-	-	110 - 200	100 - 140	-
		perlitisch	800	-	130 - 240	120 - 170	-	-	110 - 200	100 - 140	-
	Temperguss	ferritisch	450	-	120 - 240	150 - 200	-	-	100 - 200	100 - 160	-
perlitisch		750	-	120 - 240	140 - 200	-	-	100 - 200	100 - 160	-	
N	Aluminium-Knetlegierungen	nicht aushärtbar	200	-	-	800 - 1300	-	-	-	100 - 500	-
		aushärtbar, ausgehärtet	350	-	-	400 - 900	-	-	-	100 - 300	-
	Aluminium-Gusslegierungen	≤ 12% Si, ausgehärtet	250	-	-	250 - 800	-	-	-	100 - 500	-
		≤ 12% Si, aushärtbar, ausgehärtet	300	-	-	200 - 550	-	-	-	100 - 300	-
		≤ 12% Si, nicht aushärtbar	450	-	-	200 - 550	-	-	-	100 - 300	-
	Kupfer und Kupferlegierungen (Bronze/Messing)	Automatenlegierung, Pb > 1%	400	-	-	-	-	-	-	100 - 500	-
		Messing, Rotguss	300	-	-	-	-	-	-	100 - 500	-
		Aluminiumbronze	500	-	-	-	-	-	-	100 - 300	-
		Kupfer und Elektrolytkupfer	200	-	-	-	-	-	-	100 - 300	-
	Nichtmetallische Werkstoffe	Duroplaste		-	-	-	-	-	-	80 - 180	-
Faserverstärkte Kunststoffe			-	-	-	-	-	-	60 - 150	-	
Hartgummi			-	-	-	-	-	-	100 - 250	-	
S	Warmfeste Legierungen	Fe-Basis geglüht	700	20 - 50	-	20 - 50	20 - 50	-	-	-	-
		Fe-Basis ausgehärtet	950	20 - 40	-	20 - 50	20 - 40	-	-	-	-
		Ni- oder Co-Basis geglüht	800	15 - 25	-	15 - 40	15 - 25	-	-	-	-
		Ni- oder Co-Basis gegossen	1100	10 - 20	-	15 - 30	-	-	-	-	-
		Ni- oder Co-Basis ausgehärtet	1200	10 - 20	-	15 - 30	-	-	-	-	-
	Titanlegierungen	Reintitan	500 - 700	50 - 120	-	-	50 - 120	-	-	50 - 120	-
Alpha+Beta-Legierungen, ausgehärtet		700 - 1000	30 - 50	-	-	30 - 50	-	-	30 - 50	-	
H	Gehärteter Stahl	gehärtet und angelassen	1000 - 1350	-	-	-	-	-	-	-	-
		gehärtet und angelassen	1350 - 1700	-	-	-	-	-	-	-	-
	Hartguss	gegossen	1350	-	-	-	-	-	-	-	-
Gehärtetes Gusseisen	gehärtet und angelassen	1900	-	-	-	-	-	-	-	-	

Die Tabellenwerte sind Richtwerte. Es kann notwendig sein, die Werte den jeweiligen Bearbeitungsumständen anzupassen.

ISO	Material	Tensile strength [N/mm ²]	Cutting speed V _c (m/min)								
			AM5035	AK2015	AL10	AL350	AM35C	AR26C	AK10	AP40	
P	Unalloyed steel and cast steel	ca. 0,15 % C, annealed	340	120 - 230	120 - 220	200 - 300	120 - 230	140 - 250	150 - 280	-	80 - 140
		ca. 0,45 % C, annealed	640	80 - 160	100 - 160	170 - 280	80 - 160	100 - 180	120 - 200	-	70 - 100
		ca. 0,45 % C, hardened and tempered	830	80 - 160	100 - 160	160 - 250	80 - 160	100 - 180	120 - 200	-	70 - 100
		ca. 0,75 % C, annealed	900	60 - 130	80 - 140	150 - 250	60 - 130	80 - 150	100 - 180	-	60 - 100
		ca. 0,75 % C, hardened and tempered	1000	50 - 130	80 - 130	150 - 250	50 - 130	70 - 150	100 - 170	-	50 - 100
	Low alloyed steel and cast steel	annealed	600	80 - 160	100 - 160	170 - 270	80 - 160	100 - 180	120 - 200	-	60 - 100
		hardened and tempered	920	60 - 130	70 - 130	160 - 250	60 - 130	80 - 150	90 - 160	-	50 - 90
		hardened and tempered	1000	60 - 120	60 - 130	150 - 250	60 - 120	80 - 150	80 - 160	-	50 - 80
		hardened and tempered	1170	60 - 100	60 - 110	150 - 220	60 - 100	70 - 120	80 - 140	-	50 - 80
	High alloyed steel, high alloyed toolsteel and cast steel	annealed	670	80 - 140	90 - 140	-	80 - 140	100 - 160	110 - 180	-	60 - 80
hardened and tempered		1100	50 - 100	60 - 110	-	50 - 100	60 - 120	80 - 140	-	-	
Stainless steel and cast steel	ferritic / martensitic, annealed	670	50 - 200	-	160 - 280	50 - 200	100 - 180	-	-	-	
	martensitic, hardened and tempered	1000	50 - 150	-	140 - 280	50 - 150	80 - 150	-	-	-	
M	Stainless steel and cast steel	austenitic and	450 - 600	50 - 190	-	140 - 280	50 - 190	100 - 190	-	-	50 - 150
		austenitic/ferritic, chilled	600 - 900	50 - 100	-	-	50 - 100	-	-	-	40 - 90
K	Cast iron	pearlitic, ferritic	500 - 700	-	140 - 240	170 - 300	-	-	120 - 200	100 - 150	-
		pearlitic, martensitic	700 - 850	-	140 - 240	150 - 270	-	-	120 - 200	100 - 150	-
			800 - 1100	-	120 - 190	120 - 240	-	-	100 - 160	80 - 120	-
	Cast iron with nodular graphite	ferritic	550	-	130 - 240	140 - 230	-	-	110 - 200	100 - 140	-
		pearlitic	800	-	130 - 240	120 - 170	-	-	110 - 200	100 - 140	-
	Malleable cast iron	ferritic	450	-	120 - 240	150 - 200	-	-	100 - 200	100 - 160	-
pearlitic		750	-	120 - 240	140 - 200	-	-	100 - 200	100 - 160	-	
N	Aluminium alloys, long chipping	not heat treatable	200	-	-	800 - 1300	-	-	-	100 - 500	-
		heat treatable, heat - treated	350	-	-	400 - 900	-	-	-	100 - 300	-
	Casted aluminium alloys	≤ 12% Si, hardened	250	-	-	250 - 800	-	-	-	100 - 500	-
		≤ 12% Si, heat treatable	300	-	-	200 - 550	-	-	-	100 - 300	-
		≤ 12% Si, not heat treatable	450	-	-	200 - 550	-	-	-	100 - 300	-
	Copper and copper alloys (brass/bronze)	Lead alloys, Pb > 1 %	400	-	-	-	-	-	-	100 - 500	-
		Brass, bronze	300	-	-	-	-	-	-	100 - 500	-
Aluminium bronze		500	-	-	-	-	-	-	100 - 300	-	
Copper and electrolyte copper		200	-	-	-	-	-	-	100 - 300	-	
Non ferrous materials	Duroplastics		-	-	-	-	-	-	80 - 180	-	
	Re- inforced plastics		-	-	-	-	-	-	60 - 150	-	
	Hard rubber		-	-	-	-	-	-	100 - 250	-	
S	High temperature resistant alloys	Fe-alloyed, annealed	700	20 - 50	-	20 - 50	20 - 50	-	-	-	-
		Fe-alloyed, heat-treated	950	20 - 40	-	20 - 50	20 - 40	-	-	-	-
		Ni- or annealed	800	15 - 25	-	15 - 40	15 - 25	-	-	-	-
		Co - based, casting	1100	10 - 20	-	15 - 30	-	-	-	-	-
		Co - based, heat-treated	1200	10 - 20	-	15 - 30	-	-	-	-	-
	Titanium alloys, high strength	Pure titan	500 - 700	50 - 120	-	-	50 - 120	-	-	50 - 120	-
Alpha-and Be-at-alloys, hardened		700 - 1000	30 - 50	-	-	30 - 50	-	-	30 - 50	-	
H	Hardened steel	hardened and tempered	1000 - 1350	-	-	-	-	-	-	-	-
		hardened and tempered	1350 - 1700	-	-	-	-	-	-	-	-
	Hard cast iron	casting	1350	-	-	-	-	-	-	-	-
	Hardened cast iron	hardened and tempered	1900	-	-	-	-	-	-	-	-

The datas given are only approximate values. It can be necessary to adjust these datas to the individual machining operation.

ISO	Materiale	Resistenza [N/mm ²]	Velocità di taglio V _c (m/min)								
			AM5035	AK2015	AL10	AL350	AM35C	AR26C	AK10	AP40	
P	Acciaio non legati o debolmente legati	ca. 0,15 % C, ricotto	340	120 - 230	120 - 220	200 - 300	120 - 230	140 - 250	150 - 280	-	80 - 140
		ca. 0,45 % C, ricotto	640	80 - 160	100 - 160	170 - 280	80 - 160	100 - 180	120 - 200	-	70 - 100
		ca. 0,45 % C, temprato	830	80 - 160	100 - 160	160 - 250	80 - 160	100 - 180	120 - 200	-	70 - 100
		ca. 0,75 % C, ricotto	900	60 - 130	80 - 140	150 - 250	60 - 130	80 - 150	100 - 180	-	60 - 100
		ca. 0,75 % C, temprato	1000	50 - 130	80 - 130	150 - 250	50 - 130	70 - 150	100 - 170	-	50 - 100
	Acciaio debolmente legati	ricotto	600	80 - 160	100 - 160	170 - 270	80 - 160	100 - 180	120 - 200	-	60 - 100
		temprato	920	60 - 130	70 - 130	160 - 250	60 - 130	80 - 150	90 - 160	-	50 - 90
		temprato	1000	60 - 120	60 - 130	150 - 250	60 - 120	80 - 150	80 - 160	-	50 - 80
		temprato	1170	60 - 100	60 - 110	150 - 220	60 - 100	70 - 120	80 - 140	-	50 - 80
	Acciai fortemente legati, acciai da utensili	ricotto	670	80 - 140	90 - 140	-	80 - 140	100 - 160	110 - 180	-	60 - 80
temprato e rinvenuto		1100	50 - 100	60 - 110	-	50 - 100	60 - 120	80 - 140	-	-	
Acciai inossidabili e stampati	ferritico / martensitico, ricotto	670	50 - 200	-	160 - 280	50 - 200	100 - 180	-	-	-	
	martensitico, temprato	1000	50 - 150	-	140 - 280	50 - 150	80 - 150	-	-	-	
M	Acciai inossidabili e stampati	austenitico e austenitico/ferritico	450 - 600	50 - 190	-	140 - 280	50 - 190	100 - 190	-	-	50 - 150
		trattato o temprato	600 - 900	50 - 100	-	-	50 - 100	-	-	-	40 - 90
K	Ghisa grigia	perlitica, ferritica	500 - 700	-	140 - 240	170 - 300	-	-	120 - 200	100 - 150	-
		perlitica, martensitica	700 - 850	-	140 - 240	150 - 270	-	-	120 - 200	100 - 150	-
			800 - 1100	-	120 - 190	120 - 240	-	-	100 - 160	80 - 120	-
	Ghisa sferoidale	ferritica	550	-	130 - 240	140 - 230	-	-	110 - 200	100 - 140	-
		perlitica	800	-	130 - 240	120 - 170	-	-	110 - 200	100 - 140	-
	Ghisa malleabile	ferritica	450	-	120 - 240	150 - 200	-	-	100 - 200	100 - 160	-
perlitica		750	-	120 - 240	140 - 200	-	-	100 - 200	100 - 160	-	
N	Leghe di alluminio a truciolo lungo	non trattabile	200	-	-	800 - 1300	-	-	-	100 - 500	-
		temprabile, trattato	350	-	-	400 - 900	-	-	-	100 - 300	-
	Fusioni di Alluminio	≤ 12% Si, temprato	250	-	-	250 - 800	-	-	-	100 - 500	-
		≤ 12% Si, temprabile, trattato	300	-	-	200 - 550	-	-	-	100 - 300	-
		≤ 12% Si, non trattabile	450	-	-	200 - 550	-	-	-	100 - 300	-
	Leghe di Rame (Bronzo, Ottone)	Leghe di Piombo, Pb > 1 %	400	-	-	-	-	-	-	100 - 500	-
		Ottone, Bronzo	300	-	-	-	-	-	-	100 - 500	-
		Bronzo alluminio	500	-	-	-	-	-	-	100 - 300	-
		Rame e rame elettrolitico	200	-	-	-	-	-	-	100 - 300	-
	Materiali non ferrosi	Plastiche dure		-	-	-	-	-	-	80 - 180	-
Plastiche rinforzate			-	-	-	-	-	-	60 - 150	-	
Gomme dure			-	-	-	-	-	-	100 - 250	-	
S	Leghe refrattarie, Superleghe	a base di Fe, ricotto	700	20 - 50	-	20 - 50	20 - 50	-	-	-	-
		a base di Fe, temprato	950	20 - 40	-	20 - 50	20 - 40	-	-	-	-
		a base di Ni, ricotto	800	15 - 25	-	15 - 40	15 - 25	-	-	-	-
		a base di Co, da fusione	1100	10 - 20	-	15 - 30	-	-	-	-	-
		a base di Co, temprato	1200	10 - 20	-	15 - 30	-	-	-	-	-
	Leghe di Titanio	titanio puro	500 - 700	50 - 120	-	-	50 - 120	-	-	50 - 120	-
Leghe Alfa e Beta, trattate		700 - 1000	30 - 50	-	-	30 - 50	-	-	30 - 50	-	
H	Acciaio temprato	temprato e rinvenuto	1000 - 1350	-	-	-	-	-	-	-	-
		temprato e rinvenuto	1350 - 1700	-	-	-	-	-	-	-	-
	Ghisa temprata	da fusione	1350	-	-	-	-	-	-	-	-
	Ghisa trattata	temprato e rinvenuto	1900	-	-	-	-	-	-	-	-

I parametri di tagli indicati sono solo indicativi. E' necessario ottimizzarli ad ogni applicazione sulle specifiche condizioni di lavoro.

ISO	Hartmetall beschichtet Carbide coated Metallo duro rivestito	Hartmetall unbeschichtet Carbide uncoated Metallo duro non rivestito	Schneidstoff Cutting material Materiale da taglio	Anwendung Application Parametri
P Stahl, Stahlguss, langspanender Temperguss <i>Steel, cast steel, long chipping malleable iron</i> Acciaio, acciaio colato, ghisa temprata a truciolo lungo	10	AL10	Zähigkeit Toughness / Tenacità Verschleißbeständigkeit / Wear resistance / Resistenza all'usura Vorschub Feed rate / Avanzamento Schnittgeschwindigkeit Cutting speed / Velocità di taglio	Zähigkeit Toughness / Tenacità Verschleißbeständigkeit / Wear resistance / Resistenza all'usura Vorschub Feed rate / Avanzamento Schnittgeschwindigkeit Cutting speed / Velocità di taglio
	20	AR26C, AM35C, AK2015		
	30	AM5035, AP40		
	40	AL350, AM5035		
	50			
M Rostfreier Stahl, Stahlguss, Manganstahl, Automatenstahl <i>Stainless steel, cast steel, manganese steel, free cutting steel</i> Acciaio inossidabile, acciaio colato, acciaio al manganese, ghisa legata, ghisa temprata, acciaio automatico, leghe refrattarie	10	AL10	Zähigkeit Toughness / Tenacità Verschleißbeständigkeit / Wear resistance / Resistenza all'usura Vorschub Feed rate / Avanzamento Schnittgeschwindigkeit Cutting speed / Velocità di taglio	Zähigkeit Toughness / Tenacità Verschleißbeständigkeit / Wear resistance / Resistenza all'usura Vorschub Feed rate / Avanzamento Schnittgeschwindigkeit Cutting speed / Velocità di taglio
	20	AM35C		
	30	AL350, AM5035		
	40			
	50			
K Grauguss, Kokillenhartguss, kurzspanender Temperguss <i>Grey cast iron, chilled hard cast iron, short chipping malleable iron</i> Ghisa grigia, ghisa fusa in conchiglia, ghisa temprata a truciolo corto, acciaio temprato, metalli non ferrosi, plastica, legno	10	AL10, AK2015	Zähigkeit Toughness / Tenacità Verschleißbeständigkeit / Wear resistance / Resistenza all'usura Vorschub Feed rate / Avanzamento Schnittgeschwindigkeit Cutting speed / Velocità di taglio	Zähigkeit Toughness / Tenacità Verschleißbeständigkeit / Wear resistance / Resistenza all'usura Vorschub Feed rate / Avanzamento Schnittgeschwindigkeit Cutting speed / Velocità di taglio
	20	AR26C, AK10		
	30			
	40			
	50			
N Aluminium und Al-Legierungen, nichtmetallische Werkstoffe <i>Aluminium and Al-alloys, non ferrous materials</i> Alluminio e leghe di alluminio, materiali non metallici	10		Zähigkeit Toughness / Tenacità Verschleißbeständigkeit / Wear resistance / Resistenza all'usura Vorschub Feed rate / Avanzamento Schnittgeschwindigkeit Cutting speed / Velocità di taglio	Zähigkeit Toughness / Tenacità Verschleißbeständigkeit / Wear resistance / Resistenza all'usura Vorschub Feed rate / Avanzamento Schnittgeschwindigkeit Cutting speed / Velocità di taglio
	20	AK10		
	30			
	40			
	50			
S Warmfeste Legierungen, Titanlegierungen <i>High temperature resistant alloys, Titanium alloys</i> Leghe refrattarie, leghe di titanio	10	AL10	Zähigkeit Toughness / Tenacità Verschleißbeständigkeit / Wear resistance / Resistenza all'usura Vorschub Feed rate / Avanzamento Schnittgeschwindigkeit Cutting speed / Velocità di taglio	Zähigkeit Toughness / Tenacità Verschleißbeständigkeit / Wear resistance / Resistenza all'usura Vorschub Feed rate / Avanzamento Schnittgeschwindigkeit Cutting speed / Velocità di taglio
	20	AL350, AM5035, AK10		
	30			
	40			
	50			
H Gehärteter Stahl, Hartguss <i>Hardened Steel, hard cast iron</i> Acciaio temprato, ghisa conchigliata	10		Zähigkeit Toughness / Tenacità Verschleißbeständigkeit / Wear resistance / Resistenza all'usura Vorschub Feed rate / Avanzamento Schnittgeschwindigkeit Cutting speed / Velocità di taglio	Zähigkeit Toughness / Tenacità Verschleißbeständigkeit / Wear resistance / Resistenza all'usura Vorschub Feed rate / Avanzamento Schnittgeschwindigkeit Cutting speed / Velocità di taglio
	20			
	30			
	40			
	50			

Hauptanwendungsbereich / Main application area / Applicazione principale

Nebenanwendungsbereich / Secondary application area / Applicazione secondaria



Recommended cutting data
Parametri di taglio

Längsdrehen / Turning / Tornitura

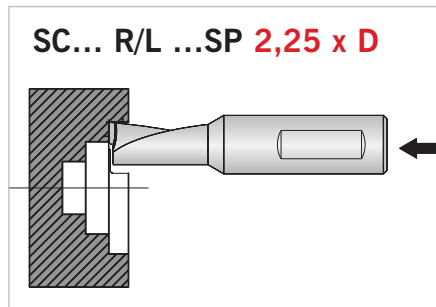

SHARK-Cut®-Ø [mm]	Spantiefe ap [mm] / Depth of cut / Profondità di passata							
	0,5	1	1,5	2	2,5	3	3,5	4
Vorschub f [mm/U] / Feed rate / Velocità di avanzamento								
SC04	0,10	0,10	0,08	0,05	-	-	-	-
SC05	0,10	0,10	0,09	0,06	0,04	-	-	-
SC06	0,10	0,10	0,10	0,08	0,06	0,04	-	-
SC07	0,10	0,10	0,10	0,10	0,08	0,06	0,04	-
SC08	0,10	0,10	0,10	0,10	0,10	0,08	0,06	0,04

Längsdrehen / Turning / Tornitura

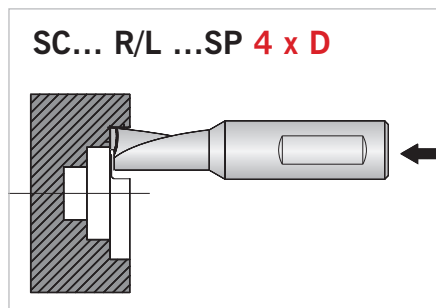

SHARK-Cut®-Ø [mm]	Spantiefe ap [mm] / Depth of cut / Profondità di passata					
	0,5	1	1,5	2	2,5	3
Vorschub f [mm/U] / Feed rate / Velocità di avanzamento						
SC04	0,10	0,08	0,050	-	-	-
SC05	0,10	0,09	0,060	0,040	-	-
SC06	0,10	0,09	0,060	0,040	-	-
SC07	0,10	0,10	0,080	0,060	0,040	-
SC08	0,10	0,10	0,085	0,075	0,055	0,040

Plandrehen / Facing / Sfacciatura

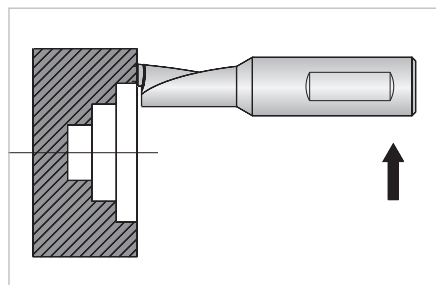

SHARK-Cut®-Ø [mm]	SC...R/L...SP (2,25 x D)		SC...R/L...SP-ALU (4 x D)	
	ap [mm]	f [mm/U]	ap [mm]	f [mm/U]
SC04	0,7	0,07	0,7	0,05
SC05	0,7	0,07	0,7	0,05
SC06	0,7	0,07	0,7	0,05
SC07	1,0	0,08	1,0	0,06
SC08	1,0	0,08	1,0	0,06

Bohren / Drilling / Foratura

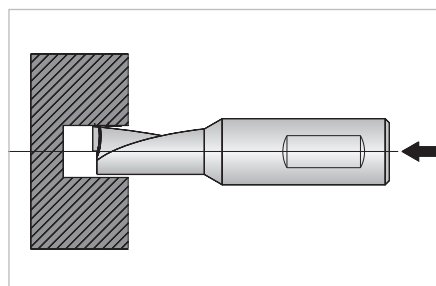

SHARK-Cut®-Ø [mm]	SC...R/L...SP (2,25 x D)	SC...R/L...SP-ALU (4 x D)
	f [mm/U]	f [mm/U]
SC04	0,005 - 0,030	0,005 - 0,020
SC05	0,005 - 0,030	0,005 - 0,020
SC06	0,005 - 0,030	0,005 - 0,020
SC07	0,005 - 0,035	0,005 - 0,025
SC08	0,005 - 0,040	0,005 - 0,030

4

Längsdrehen / Turning / Tornitura

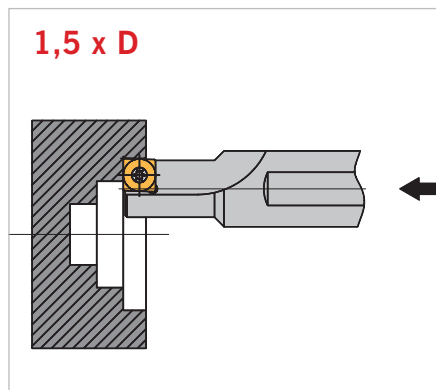

SHARK-Cut®-Ø [mm]	Spantiefe ap [mm] / Depth of cut / Profondità di passata											
	1	2	3	4	5	6	7	8	9	10	12	14
Vorschub f [mm/U] / Feed rate / Velocità di avanzamento												
SC08...(LP...04)	0,12	0,11	0,10	0,07	-	-	-	-	-	-	-	-
SC10...(LP...05)	0,15	0,15	0,12	0,10	0,09	-	-	-	-	-	-	-
SC12...(LP...06)	0,16	0,16	0,15	0,13	0,12	0,10	-	-	-	-	-	-
SC14...(LP...07)	0,18	0,18	0,18	0,15	0,13	0,11	-	-	-	-	-	-
SC16...(LP...08)	0,20	0,20	0,20	0,19	0,17	0,15	0,14	0,12	-	-	-	-
SC18...(LP...09)	0,21	0,21	0,21	0,21	0,19	0,17	0,16	0,14	-	-	-	-
SC20...(LP...10)	0,22	0,22	0,22	0,22	0,22	0,21	0,19	0,17	0,16	0,15	-	-
SC25...(LP...13)	0,26	0,26	0,26	0,26	0,26	0,26	0,25	0,23	0,22	0,20	0,16	-
SC32...(LP...17)	0,30	0,30	0,30	0,30	0,30	0,30	0,30	0,28	0,27	0,25	0,17	0,18

Längsdrehen / Turning / Tornitura

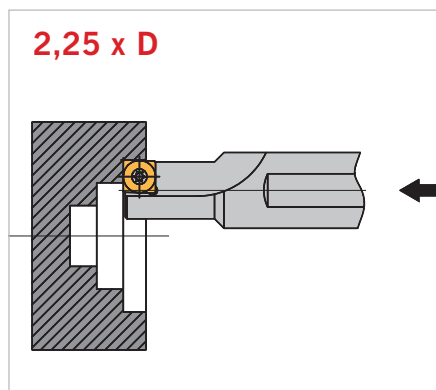

SHARK-Cut®-Ø [mm]	Spantiefe ap [mm] / Depth of cut / Profondità di passata						
	1	2	2,5	3	3,5	4	5
Vorschub f [mm/U] / Feed rate / Velocità di avanzamento							
SC08...(LP...04)	0,12	0,09	0,07	-	-	-	-
SC10...(LP...05)	0,15	0,12	0,10	0,09	-	-	-
SC12...(LP...06)	0,16	0,16	0,13	0,12	0,10	-	-
SC14...(LP...07)	0,18	0,18	0,16	0,14	0,11	-	-
SC16...(LP...08)	0,20	0,20	0,18	0,16	0,14	0,12	-
SC18...(LP...09)	0,21	0,21	0,20	0,18	0,16	0,14	-
SC20...(LP...10)	0,22	0,22	0,22	0,21	0,19	0,17	0,12
SC25...(LP...13)	0,28	0,28	0,28	0,28	0,25	0,23	0,20
SC32...(LP...17)	0,30	0,30	0,30	0,30	0,28	0,28	0,25

Längsdrehen / Turning / Tornitura

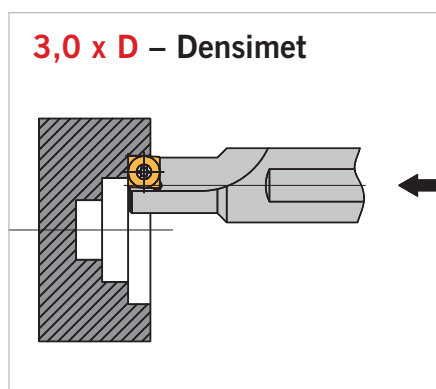

SHARK-Cut®-Ø [mm]	Spantiefe ap [mm] / Depth of cut / Profondità di passata						
	1	2	2,5	3	3,5	4	5
Vorschub f [mm/U] / Feed rate / Velocità di avanzamento							
SC08...(LP...04)	0,12	0,09	0,07	-	-	-	-
SC10...(LP...05)	0,13	0,11	0,09	0,07	-	-	-
SC12...(LP...06)	0,15	0,13	0,12	0,11	0,10	-	-
SC14...(LP...07)	0,16	0,16	0,15	0,13	0,11	-	-
SC16...(LP...08)	0,18	0,18	0,17	0,15	0,13	0,12	-
SC18...(LP...09)	0,20	0,20	0,18	0,17	0,15	0,14	-
SC20...(LP...10)	0,22	0,22	0,22	0,21	0,19	0,16	0,14
SC25...(LP...13)	0,25	0,25	0,25	0,25	0,23	0,22	0,18
SC32...(LP...17)	0,28	0,28	0,28	0,28	0,28	0,28	0,22

Längsdrehen / Turning / Tornitura

Werkstoff Material Materiale	Elastizitätsmodul [kg/mm²] Modulus of elasticity Modulo di elasticità	Dichte [g/cm³] Thickness Peso specifico
Densimet	360	17,50
Stahl	210	7,85

Höchste Präzision bei hervorragender Oberflächengüte und gesteigerten Standzeiten werden durch hohes Elastizitätsmodul und hohe Dichte erreicht, da diese besonders schwingungsdämpfend wirken.

Absolute precision, excellent surface quality and improved tool life have been achieved as a result of the high modulus of elasticity and density since these particularly reduce vibrations.

Assoluta precisione, eccellente finitura superficiale ed incremento delle vita utensile sono ottenute da un materiale antivibrante risultato di un abbinamento tra un elevato modulo di elasticità ed un elevato peso specifico.

Recommended cutting data
Parametri di taglio

Plandrehen / Facing / Sfacciatura

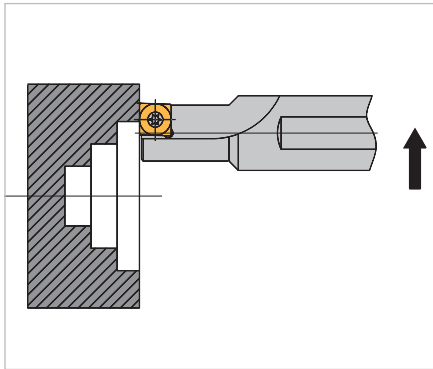

SHARK-Cut®-Ø [mm]	1,5 x D		2,25 x D		3 x D – Densimet	
	ap [mm]	f [mm/U]	ap [mm]	f [mm/U]	ap [mm]	f [mm/U]
SC08...(LP..04)	2,00	0,10	1,50	0,07	1,00	0,10
SC10...(LP..05)	2,50	0,12	2,00	0,12	1,20	0,12
SC12...(LP..06)	3,00	0,15	2,50	0,14	1,50	0,15
SC14...(LP..07)	3,50	0,16	3,00	0,15	1,70	0,16
SC16...(LP..08)	4,00	0,17	3,50	0,16	2,00	0,17
SC18...(LP..09)	5,00	0,18	3,50	0,17	2,30	0,18
SC20...(LP..10)	5,00	0,20	4,00	0,18	2,50	0,20
SC25...(LP..13)	6,00	0,24	5,00	0,22	3,00	0,24
SC32...(LP..17)	8,00	0,27	6,00	0,26	3,50	0,27

Bohren / Drilling / Foratura

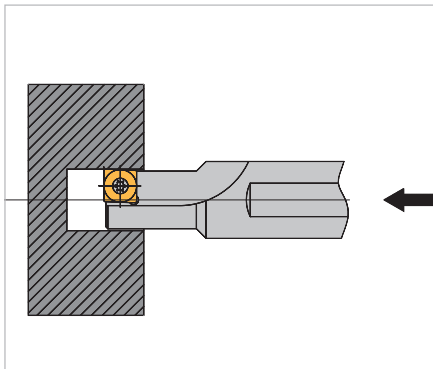

SHARK-Cut®-Ø [mm]	1,5 - 2,25 x D	3 x D – Densimet
	f [mm/U]	f [mm/U]
SC08...(LP..04)	0,01 - 0,04	0,01 - 0,02
SC10...(LP..05)	0,01 - 0,05	0,01 - 0,03
SC12...(LP..06)	0,01 - 0,05	0,01 - 0,04
SC14...(LP..07)	0,01 - 0,07	0,01 - 0,05
SC16...(LP..08)	0,02 - 0,08	0,02 - 0,06
SC18...(LP..09)	0,03 - 0,09	0,03 - 0,07
SC20...(LP..10)	0,03 - 0,10	0,03 - 0,08
SC25...(LP..13)	0,03 - 0,12	0,04 - 0,09
SC32...(LP..17)	0,05 - 0,15	0,05 - 0,11

Aufbohren / Boring / Barenatura

2-schneidig

2 flute

2 taglienti

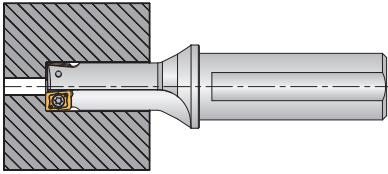

SHARK-Cut® Rebore- Ø [mm]	Spantiefe ap [mm] / Depth of cut / Profondità di passata													
	1	2	3	4	5	6	7	8	9	10	12	14		
Vorschub f [mm/U] / Feed rate / Velocità di avanzamento														
12 - 15 (LP..04)	0,25	0,22	0,20	0,16	-	-	-	-	-	-	-	-	-	-
16 - 17,5 (LP..05)	0,30	0,30	0,28	0,24	0,20	-	-	-	-	-	-	-	-	-
18 - 19 (LP..06)	0,34	0,34	0,34	0,30	0,25	0,20	-	-	-	-	-	-	-	-
20 - 23 (LP..07)	0,36	0,36	0,36	0,33	0,30	0,26	0,22	-	-	-	-	-	-	-
24 - 25(LP..08)	0,42	0,42	0,42	0,42	0,38	0,34	0,30	0,25	-	-	-	-	-	-
26 - 28 (LP..09)	0,44	0,44	0,44	0,44	0,44	0,40	0,35	0,32	0,28	-	-	-	-	-
29 - 24(LP..10)	0,48	0,48	0,48	0,48	0,48	0,45	0,40	0,36	0,32	0,30	-	-	-	-
35 - 44 (LP..13)	0,52	0,52	0,52	0,52	0,52	0,52	0,50	0,47	0,43	0,38	0,30	-	-	-
45 - 50 (LP..17)	0,60	0,60	0,60	0,60	0,60	0,60	0,60	0,60	0,60	0,55	0,50	0,42	0,35	-

Aufbohren / Boring / Barenatura

3-schneidig

3 flute

3 taglienti

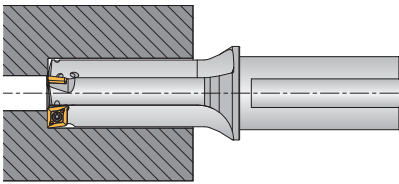

SHARK-Cut® Rebore- Ø [mm]	Spantiefe ap [mm] / Depth of cut / Profondità di passata													
	1	2	3	4	5	6	7	8	9	10	12	14		
Vorschub f [mm/U] / Feed rate / Velocità di avanzamento														
24 - 25 (LP..06)	0,51	0,51	0,51	0,45	0,38	0,30	-	-	-	-	-	-	-	-
26 - 28 (LP..07)	0,54	0,54	0,54	0,49	0,45	0,39	0,33	-	-	-	-	-	-	-
29 - 34 (LP..08)	0,63	0,63	0,63	0,63	0,57	0,51	0,45	0,38	-	-	-	-	-	-
35 - 40 (LP..09)	0,66	0,66	0,66	0,66	0,66	0,60	0,53	0,48	0,42	-	-	-	-	-
41 - 47 (LP..10)	0,72	0,72	0,72	0,72	0,72	0,68	0,60	0,54	0,48	0,45	-	-	-	-
48 - 50 (LP..13)	0,78	0,78	0,78	0,78	0,78	0,78	0,75	0,70	0,65	0,57	0,45	-	-	-

Maximale Bohrtiefen / Maximum drilling depth / Massima profondità di foratura

Maximale Bohrtiefen / Maximum drilling depth / Massima profondità di foratura					
SHARK-Cut®-Ø [mm]	Mini (2,25 x D) [mm]	Mini ALU (4 x D) [mm]	1,5 x D [mm]	2,25 x D [mm]	3 x D [mm]
4	9,00	16	-	-	-
5	11,25	20	-	-	-
6	13,50	24	-	-	-
7	15,75	28	-	-	-
8	18,00	32	12	18,0	24
10	-	-	15	22,0	30
12	-	-	18	27,0	36
14	-	-	21	31,5	42
16	-	-	24	36,0	48
18	-	-	27	40,5	54
20	-	-	30	45,0	60
25	-	-	38	56,0	75
32	-	-	48	72,0	96

Bohren aus der Mitte / Drilling off centre / Foratura fuori centro

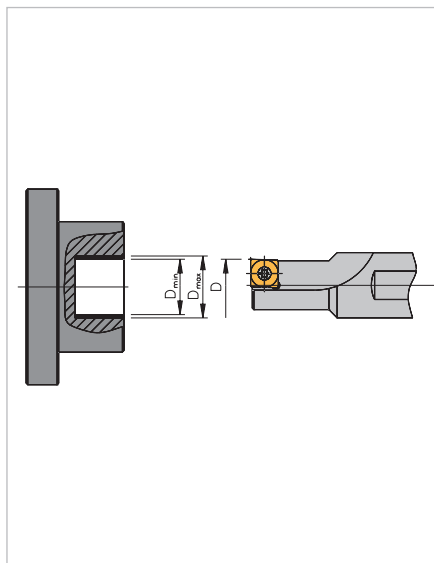

Werkzeugtyp Type of tool Tipo di utensile	Werkzeug-Nennendurchmesser Nominal tool diameter Diametro Nominale utensile	Werkstück-Bohrdurchmesser Drilling diameter Diametri ottenibili	
	D [mm]	D _{min} [mm]	D _{max} [mm]
SC 04 R/L-...SP...(Mini)	4	3,90	4,2
SC 05 R/L-...SP...(Mini)	5	4,90	5,2
SC 06 R/L-...SP...(Mini)	6	5,90	6,2
SC 07 R/L-...SP...(Mini)	7	6,90	7,2
SC 08 R/L-...SP...(Mini)	8	7,90	8,2
SC 08 R/L-...04	8	7,85	8,3
SC 10 R/L-...05	10	9,85	10,5
SC 12 R/L-...06	12	11,85	12,5
SC 14 R/L-...07	14	13,85	14,5
SC 16 R/L-...08	16	15,85	16,5
SC 18 R/L-...09	18	17,85	18,5
SC 20 R/L-...10	20	19,80	20,5
SC 25 R/L-...13	25	24,80	25,8
SC 32 R/L-...17	32	31,80	33,0

Durch die speziell entwickelte und aufeinander abgestimmte Ausführung von Werkzeug und Wendeschneidplatte ist es möglich außer Mitte zu bohren. Es können somit Abweichungen zum Werkzeugdurchmesser erreicht werden.

Because of the special design of the holder and indexable inserts, it is possible to drill off centre.

Grazie allo speciale profilo dell'inserto e utensile è possibile forare fuori centro.

Coolant-Booster / Coolant-Booster / Ugelli Booster

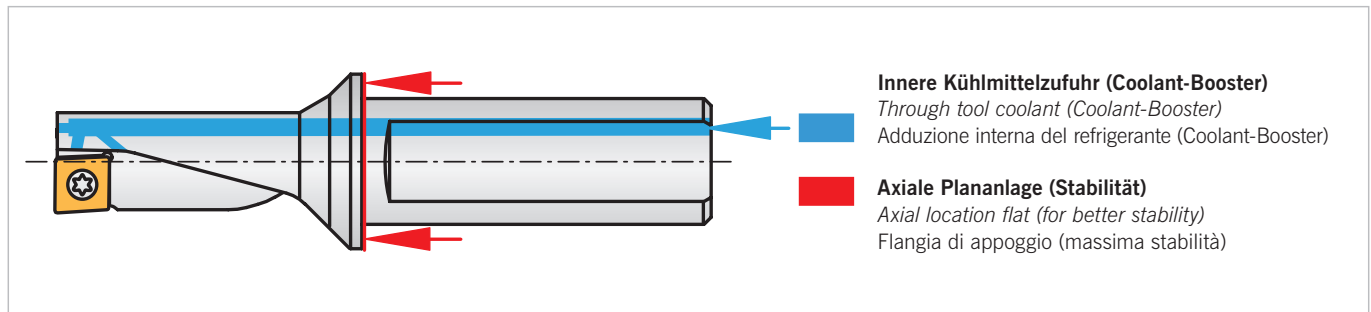

Kühlmitteldruck

Als innovative Detaillösung bietet der SHARK-Cut® eine spezielle Kühlmittelzufuhr zur besseren Ausbringung der Späne aus der Bohrung. Ein eigener, rückwärtsgerichteter Kühlmittelstrahl sorgt für einen verbesserten Spänetransport. Der Kühlmitteldruck muss dafür, unabhängig vom Durchmesser, ca. 1,5–3 bar (optimal 5–7 bar) betragen.

Coolant pressure

The SHARK-Cut® tool offer a unique detail when it comes to swarf evacuation. A "return" (pointing back up the flute) coolant channel ensures optimum swarf evacuation, therefore the coolant pressure, no matter the diameter, must be 1.5–3 bar (optimum 5–7 bar).

Pressione del refrigerante

Lo SHARK-Cut® offre un dettaglio unico per l'aiuto nell'evacuazione truciolo. Un ugello orientato in direzioni di uscita del foro aiuta il truciolo ad incanalarsi e ad essere espulso. La pressione suggerita, indipendente dal diametro deve essere di almeno 1,5–3 bar (optimale 5–7 bar).

Achsversatz der Maschine / Displacement of the machine / Montaggio sulla macchina utensile

4

<p>Situation / Situation / Condizione</p> <p>Versatz in X-Richtung Displacement in X-direction Collisione lungo l'asse X</p>		<p>Lösung / Solution / Soluzione</p> <p>Werkzeugkorrektur anpassen Correct tool positioning Correggere posizione</p>
<p>Situation / Situation / Condizione</p> <p>Winkelfehler Angle error Orientamento errato</p>		<p>Lösung / Solution / Soluzione</p> <p>Revolver und/oder Spindelstock ausrichten Turret and/or spindle adjustment Registrare torretta e/o mandrino</p>
<p>Situation / Situation / Condizione</p> <p>Revolver-Positionierfehler Turret positioning error Posizionamento della torretta errato</p>		<p>Lösung / Solution / Soluzione</p> <p>Revolverscheibe ausrichten (Y-Achse) Adjust turret plate (Y-axis) Registrare piano torretta (Asse Y)</p>

WIPER-Geometrie / WIPER-Geometry / WIPER-Geometria
Funktionsprinzip (Nutzen) / Information / Obiettivi

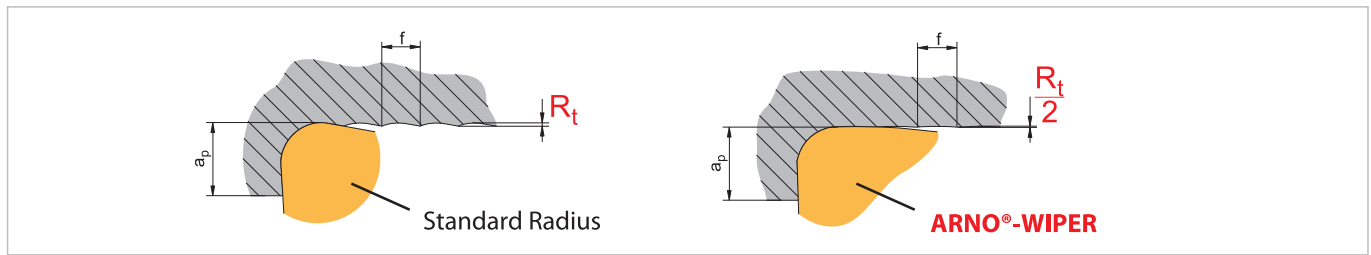

Bessere Oberfläche

Bei gleichem Vorschub erreicht die Wende-schneidplatte mit WIPER-Schneide einen um das Vielfache besseren R_a -Wert gegenüber einer herkömmlichen Wende-schneidplatte.

Better surface

At the same feed rate the WIPER insert achieves a much better R_a -value against a conventional insert.

Migliore finitura superficiale

Con i medesimi avanzamenti dell'inserto normale, la geometria WIPER assicura un migliore valore R_a .

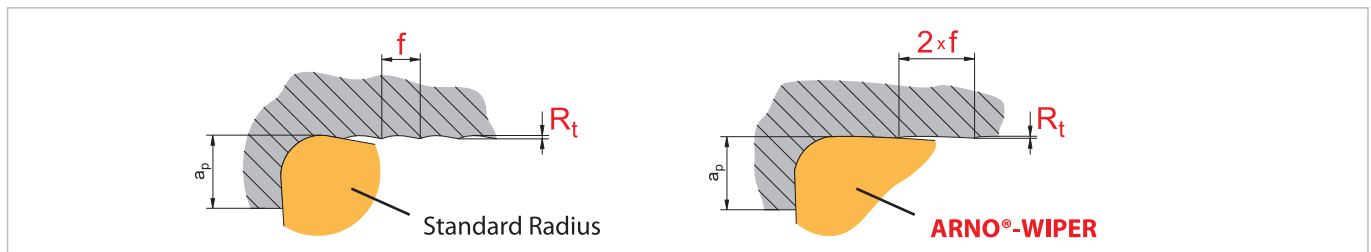

Geringere Bearbeitungszeit

Soll der gleiche R_a -Wert erreicht werden wie mit einer Standard-Wende-schneidplatte, so kann mit der Schneidplatte mit WIPER-Schneide der doppelte Vorschub gefahren werden (= geringere Stückzeiten!).

Reduced machine time

If the required R_a -value is achieved with a standard insert, the insert can be applied using up to twice the feed rate and thereby reducing machine time.

Riduzione tempo ciclo

La geometria WIPER permette avanzamenti anche doppi rispetto agli inserti a raggio standard assicurando pari rugosità superficiale. Questa caratteristica arriva a dimezzare i tempi ciclo, specialmente in operazioni di barenatura.

Bearbeitung über Mitte / Machining over centre / Lavorazione fuori asse

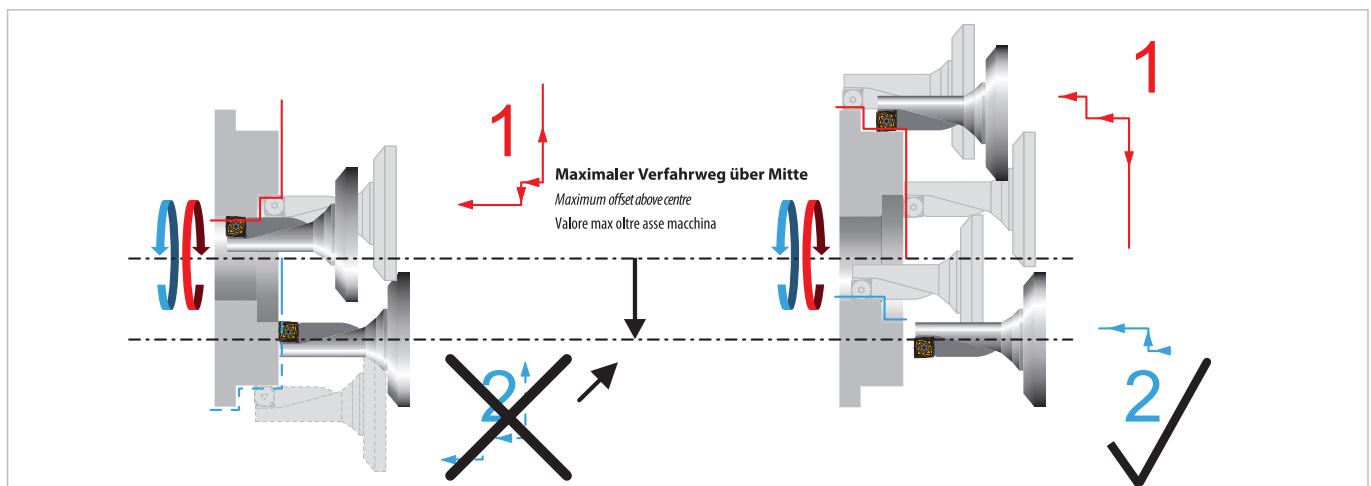

Situation / Situation / Condizione

Bei nicht ausreichendem Verfahrweg der Maschine über die Mittel-achse ist der Außendurchmesser nicht mit dem selben Werkzeug bearbeitbar.

At not adequate travel of the machine over the centre the outside diameter can not be machined with the same tool.

Nel caso di corse ridotte delle macchine utensili i diametri esterni possono non essere lavorabili con il medesimo utensile.

Lösung / Solution / Soluzione

Verwendung eines rechten SHARK-Cut® Werkzeuges.

Using a right hand SHARK-Cut® tool.

Utilizzare un utensile SHARK-Cut® destro.

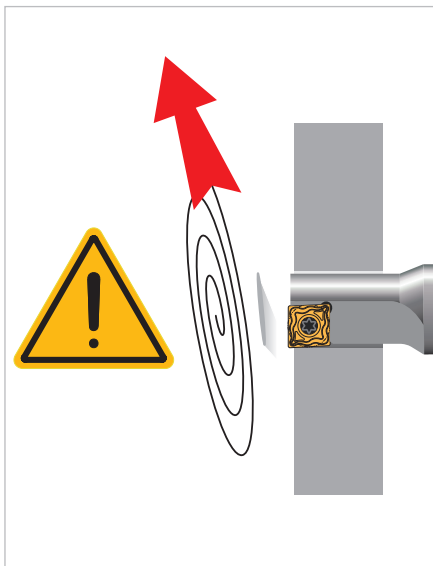
Durchgangsbohrung / Through hole drilling / Foratura passante**Hinweis**

Bei feststehendem Werkzeug und rotierendem Werkstück fällt bei Durchgangsbohrungen eine scharfkantige Ronde ab. Bitte Sicherheitsvorkehrungen treffen.

Der Kühlmitteldruck sollte für SHARK-Cut® 2,25 x D ca. 5–7 bar und für SHARK-Cut® 1,5 x D ca. 1,5–3 bar betragen. Ist der notwendige Kühlmitteldruck maschinen-seitig nicht vorhanden, kann es von Vorteil sein, den Bohrvorgang kurz zu unterbrechen, um die Bohrung zu entleeren.

Information

When through hole drilling with stationary tool and rotating component a sharp disc is produced, please ensure adequate safety precautions.

The coolant pressure for a 1.5 x D SHARK-Cut® should be minimum 1.5–3 bar, for 2.25 x D drill depth 5–7 bar is required. If the necessary coolant pressure is not available, it could be beneficial to interrupt the cutting briefly in order to clear the hole.

Accorgimenti

In operazioni di foratura passante con utensile fisso, un disco affilato risulta a fine operazione, assicurare adeguate protezioni.

La pressione del refrigerante per un utensile SHARK-Cut® 1,5 x D deve essere minimo 1,5–3 bar, mentre per la versione 2,25 x D è suggerito un minimo di 5–7 bar. Nei casi in cui la pressione del refrigerante non fosse sufficiente è suggerito prevedere una lavorazione con interruzioni per assicurare una giusta evacuazione truciolo.

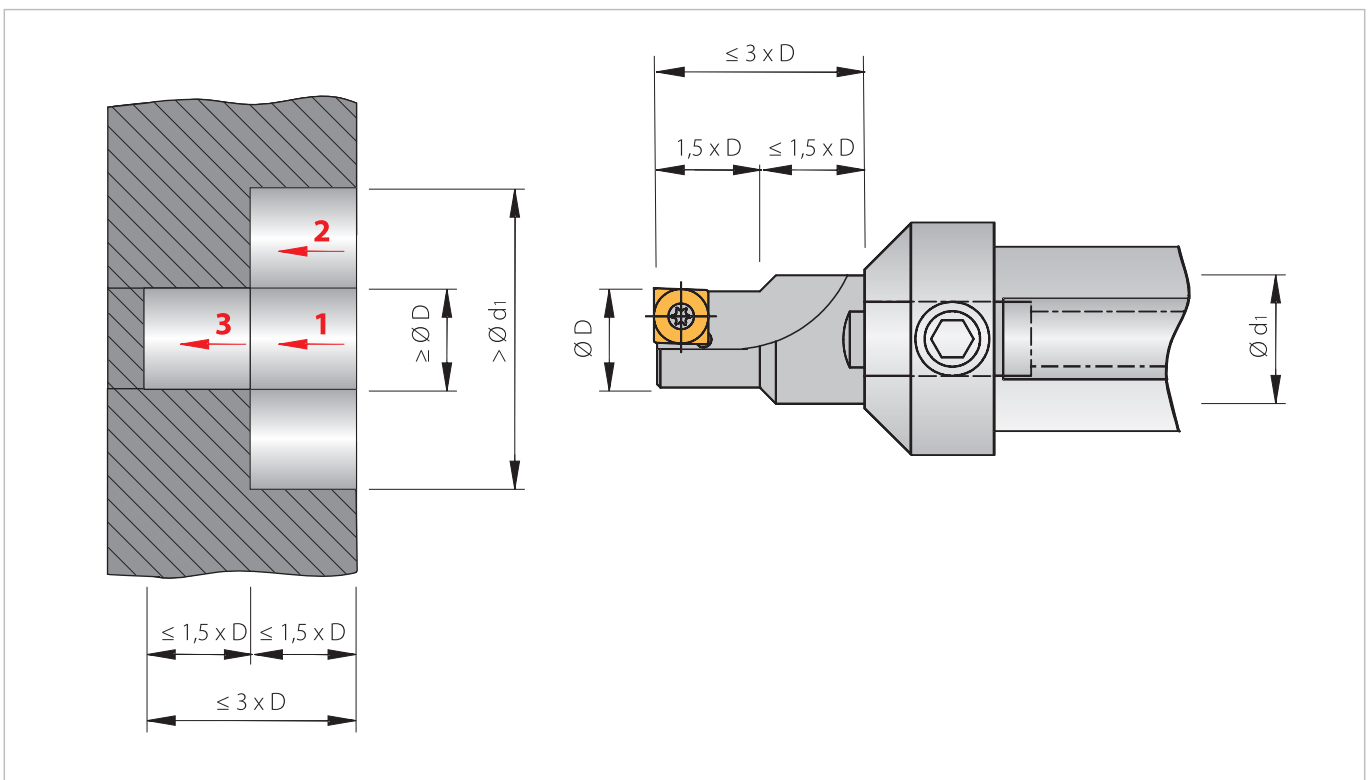
Bohrtiefen bis 3 x D / Deep bores up to 3 x D / Per forature fino a 3 x D

Mit SHARK-Cut® Werkzeugen SC..1,5 x D können bei entsprechender Werkstückkontur, Bohrtiefen bis zum Dreifachen des Nenn-durchmessers erreicht werden (siehe Bild). Es ist dabei auf die Arbeitsabfolge 1, 2 und 3 zu achten. Für Werkzeuge mit dem Durchmesser 8 mm werden rechte und linke Wendeschneidplatten benötigt. Für Werkzeuge mit Durchmesser 10 bis 32 mm kommen neutrale Wendeschneidplatten zum Einsatz.

With the SHARK-Cut® tools SC..1.5 x D it is possible to drill up to three times the diameter (see picture). However please note working order 1, 2 and 3. For holders with diameter 8 mm use inserts with right and left chip breakers. For holders with diameter 10 to 32 mm use neutral inserts.

Con corpo utensile SC..1,5 x D è possibile forare fino a 3 x D a condizione che la forma del foro corrisponda alla figura. Prestare attenzione all'ordine 1, 2 e 3. Per utensili diametro 8 mm prestare attenzione agli inserti che hanno versione Destra e Sinistra. Per utensili superiori a 10 a 32 mm di diametro gli inserti sono neutri.

Werkzeug zum Aufbohren mit 2 bzw. 3 Schneiden.

Tools for boring with 2 or 3 edges.

Utensile per barenatura con 2 o 3 inserti.

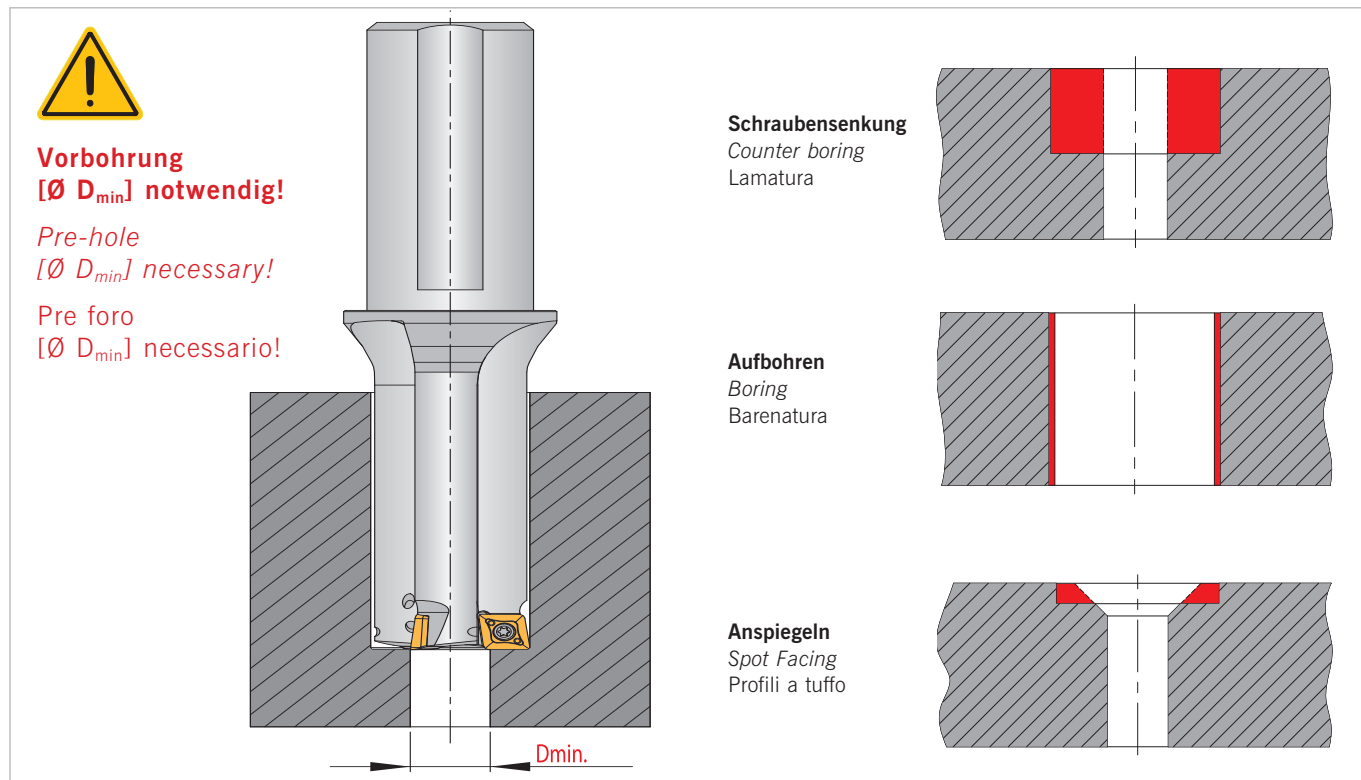

Formeln / Formulas / Formule

Schnittgeschwindigkeit

Cutting Speed
Velocità di taglio

$$V_c = \frac{\pi \cdot D \cdot n}{1000}$$

Drehzahl

Revolution per minute
Numero di giri al minuto

$$n = \frac{V_c \cdot 1000}{\pi \cdot D}$$

Zeitspanvolumen

Chip removal rate
Volume truciolo

$$Q = V_c \cdot a_p \cdot f_n$$

D	Durchmesser Diameter Diametro	[mm]	f_n	Vorschub pro Umdrehung Feed rate per revolution Avanzamento al giro	[mm/U]	n	Spindeldrehzahl Spindel revolution Numero di giri	[U/min]
V_c	Schnittgeschwindigkeit Cutting speed Velocità di taglio	[m/min]	a_p	Schnitttiefe Depth of cut Profondità di passata	[mm]	Q	Zeitspanvolumen Chip removal rate Volume truciolo	[cm ³ /min]

Anwendungsproblem / Type of problem / Tipo di problema								Abhilfe Corrective measures Soluzioni possibili	Kriterium / Criteria / Criterio
Ausbrüche Edge chipping Scheggiatura inserto	Aufbauschneide Built-up edge Tagliente di riporto	Freiflächenverschleiß Wear in clearance face Labbro di usura	Plastische Verformung Plastic deformation Deformazione plastica	Vibrationen Vibrations Vibrazioni	Oberflächengüte Surface finish Finitura superficiale	Span zu lang Chip too long Truciolo lungo	Span zu kurz Chip too short Truciolo troppo corto		
	↑	↓	↓	↓	↑	↓		Schnittgeschwindigkeit Cutting speed Velocità di taglio	Schnittwerte / Cutting values / Parametri di taglio
↓		~	↓	↑	↓	↑	↓	Vorschub Feed Avanzamento	
↑		↑	↑	↓	↑			Eckenradius Corner radius Raggio di punta	Wende- schneidplatten / Insert selection / Scelta inserto
↓		↑	↑					Schneidstoff Cutting material Materiale da taglio	
~				~	~			Spannung Werkzeug Tool clamping Bloccaggio utensile	Allgemeine Kriterien / General criteria / Accorgimenti generali
~				~	~			Spannung Werkstück Workpiece clamping Bloccaggio pezzo	
~				~	↓			Auskragung Overhang Sporgenza	
~		~		~	~			Spitzenhöhe Tip height Altezza tagliente	
	•	•	•		•	•		Kühlschmierstoff Cooling lubricant Lubro-refrigerante	



erhöhen, vergrößern - großer Einfluss
increase, bigger effect
aumentare notevolmente i valori



senken, verkleinern - großer Einfluss
increase, bigger effect
aumentare notevolmente i valori



erhöhen, vergrößern - kleiner Einfluss
increase, smaller effect
aumentare leggermente i valori



senken, verkleinern - kleiner Einfluss
reduce, smaller effect
diminuire notevolmente i valori



verwenden
apply
utilizzare



kontrollieren, optimieren
check, optimize
controllare, ottimizzare

VOLLHARTMETALL-SPIRALBOHRER



Vollhartmetall-Spiralbohrer

- Systemvorstellung
- Bezeichnungssystem
- Werkzeugauswahl
- Vollhartmetall-Spiralbohrer
- Anwendungshinweise

Solid carbide drills

- Introduction
- Designation system
- Tool shank options
- Solid carbide drills
- Application reference

Punte in metallo duro integrale

- Caratteristiche del sistema
- Sistema di numerazione
- Tipologie di numerazione
- Punte in metallo duro integrale
- Suggerimenti tecnici

200 – 201
200
202 – 204
205 – 248
249 – 256

5

5

ARNO® Vollhartmetallbohrer

ARNO® solid carbide drills

Punte in metallo duro integrale



- ARNO® VHM-Bohrer sind durch ihre spezielle Konstruktion und höchste Genauigkeit geeignet zum Hochgeschwindigkeitsbohren und für genaue Bohrungen
- gute Leistung bei Stählen, Grauguss, Werkzeugstählen, Stahllegierungen sowie bei rost- und säurebeständigen Stählen
- schnelle Spanabfuhr und hervorragender Spanbruch durch speziell entwickelte Schneidengeometrien und Spankammern
- hohe Genauigkeit und Stabilität
- höhere Standzeiten durch TiAlN-Beschichtung
- selbstzentrierend

- ARNO® solid carbide drills are suitable for high speed and accurate drilling operations by special design and high quality
- good performance in steels, cast iron, tool steel, alloy steels and stainless steels
- rapid chip evacuation and excellent chip breaking can be achieved by special designed cutting edges on point and chipbreakers on leading edges
- high accuracy and stability
- longer tool life by TiAlN coating
- self-centring

- Le punte in M.D.I. ARNO® sono adatte per alte prestazioni e accurate operazioni di foratura
- Ottime prestazioni sugli Acciai, Ghisa, Acciai da stampi e Acciai inossidabili, acciai temprati
- Evacuazione del truciolo rapida ed eccellente rottura del truciolo raggiunto per mezzo di un disegno speciale del tagliente sulla punta
- Alta precisione e stabilità
- Durata dell'utensile maggiore grazie il rivestimento TiAlN
- Autocentrante

Bezeichnungssystem

Designation system

Sistema di numerazione

5



SP	C	0090	-0450	VHM	TiAlN
VHM- und PM-HSS-Spiralbohrer	mit innerer Kühlmittelzufuhr	Durchmesser	Bohrtiefe	Schneidstoff	Beschichtung
Solid carbide drills and powder metal drills	with through tool coolant	Diameter	Drill depth	Cutting material	Coating
Punte in M.D.I. e punte elicoidali in HSS-PM	Con adduzione interna del refrigerante	Diametro	Profondità foro	Materiale da taglio	Rivestimento

VHM- und PM-HSS-Spiralbohrer

Solid carbide drills and powder metal drills
Punte in M.D.I. e punte elicoidali in HSS-PM

Merkmale VHM- und PM-HSS-Spiralbohrer

Characteristics of solid carbide drills and powder metal drills
Caratteristiche di punte in M.D.I. e punte elicoidali in HSS-PM

ARNO®-Vollhartmetallbohrer sind aus Feinstkorn-Hartmetall (Ultra-Micro-Grain) gefertigt. Die Korngrößen betragen 0–0,5 µm und je nach Ausführung sind sie mit verschiedenen Beschichtungen versehen (TiAlN, TiCN bzw. Diamant).

The ARNO® solid carbide drills are made from ultra micrograin carbide. The grainsize is between 0–0.5 micron and coated depending on application with various coatings (TiAlN, TiCN or TiAl7O).

Le punte elicoidali ARNO® in metallo duro integrale vengono realizzate da metallo duro ultra-micrograna con dimensione dei granuli 0,5 micron max. Il rivestimento TiAlN assicura durata e affidabilità nella lavorazione.

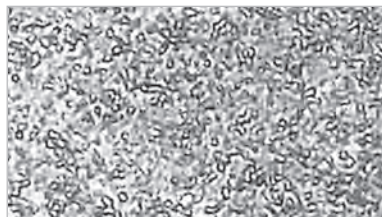

Feinstkorn-Hartmetall-Kornstruktur Ultra-Micro-Grain, Korngrößen 0–0,5 µm.

Finegrain-hardmetal structure Ultra-micro-grain, grain size 0–0.5 micron.

Struttura dei granuli di metallo duro Ultra Micro Grana (max 0,5 micron).

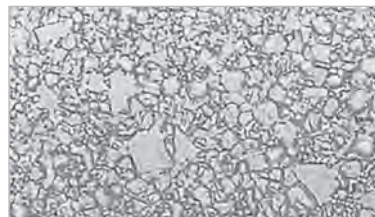

Allgemeine Hartmetall-Kornstruktur.

General carbide structure.

Struttura dei granuli di metallo duro comune.

Pulvermetallurgische HSS-Bohrer ... die neue Pulverstahl-Generation! Extrem zäh und verschleißfest.

Powder metal HSS drills... the new powder steel generation!
Very tough and wear resistant.

Punte elicoidali in HSS-PM ... la nuova generazione di acciaio HSS sinterizzato!
Per la massima performance in termini di tenacità e resistenza all'usura.

Ein Premium-HSS-Stahl, der alle bisherigen Leistungsmerkmale in den Schatten stellt. Es ist gelungen, den Anteil eingeschlossener oxydischer Gaskomponenten und Schlackepartikel im Stahl auf ein Minimum zu reduzieren. Dieser besonders homogene Pulverstahl garantiert beste Zerspanungsergebnisse.

This PM-HSS-steel overshadows the performance of all previous results. We have succeeded to reduce the oxide components and particles in the steel to an absolute minimum. This especially pure powdersteel guarantees the best cutting performance.

Questo nuovo acciaio sinterizzato PM-HSS supera in tutti i campi il tradizionale HSS. Riuscendo in questo processo a ridurre al minimo occlusioni e garantendo una struttura uniforme del materiale, questo nuovo speciale acciaio da polvere garantisce le massime prestazioni performance.

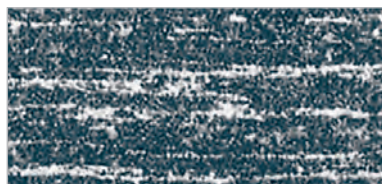

Herkömmlicher HSS-Bohrer
• spröde Kornstruktur
• begrenzte Festigkeit

Original HSS-drills
• brittle construction
• limited strength

Struttura di HSS classico
• struttura fragile
• limitata resistenza

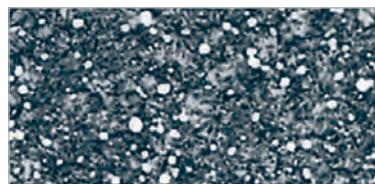

Pulvermetallurgischer HSS-Bohrer
• feine Mikro-Kornstruktur
• gleichmäßige Kornverteilung
• höchste Festigkeit

Powder metallurgy HSS-drills
• fine micro grain structure
• even grain formation
• highest strength

Struttura di HSS-PM
• struttura a grani fine
• struttura compatta e uniforme
• massima resistenza

Im herkömmlich gegossenen Schnellarbeitsstahl sind die Karbidzeilen häufig so groß, dass es auf die Menge eingeschlossener ca. 10–20 µm großer Schlackepartikel meist nicht ankommt. Die oben abgebildete Darstellungen zeigen deutlich, dass im pulvermetallurgischen Stahl die Karbide wesentlich kleiner (ca. 1–3 µm) sind. Dadurch wird der Einschluss von Schlackepartikeln nur in ganz geringem Maße ermöglicht.

In traditional high speed steel the grain size is often so big, that the amount of 10–20 µm larger particles makes no difference. The above pictures shows clearly that in powder steel the grain size is much smaller (approx 1–3 µm). Therefore the contamination by particles is much reduced.

Negli HSS tradizionali la dimensione dei granuli della struttura raggiunge spesso i 10–20 µm. Le figura sopra riportate mostrano chiaramente la differenza sia di dimensione dei granuli (circa 1–3 µm) e sia della uniformità della struttura.

Das Resultat: Ein sehr reiner Stahl, der das Risiko des Werkzeugversagens aufgrund metallischer Einschlüsse stark reduziert.

The Result: A very clean steel, which strongly reduces the risk of tool breakage due to contamination.

Il Risultato: Un acciaio uniforme, senza tensioni interne, molto compatto e privo di impurità che garantisce caratteristiche meccaniche superiori.

Werkzeugauswahl

Tool shank options

Tipologie di attacco utensile

Ausführung Design Esecuzione	Bohrertyp Type Tipo	Innenkühlung Through tool coolant Aduzione interna refrigerante	Durchmesser Diameter Diametro [mm]	Abb. Picture Immagine	Seite Page Pagina
3 x D					
3 x D	Vollhartmetall-Spiralbohrer <i>Solid carbide drill</i> Punta elicoidale in metallo duro	X	1,0–10,0 (<i>unbeschichtet / non rivestito</i>) 1,0–20,0 (<i>beschichtet / coated / rivestito</i>)		206
3 x D	Vollhartmetall-Spiralbohrer <i>Solid carbide drill</i> Punta elicoidale in metallo duro	✓	1,0–20,0		210
3 x D	Vollhartmetall-Spiralbohrer <i>Solid carbide drill</i> Punta elicoidale in metallo duro für Aluminium / for aluminium / per alluminio diamant beschichtet / diamant coated / rivestito diamante	✓	3,0–20,0		212
3 x D	Vollhartmetall-Spiralbohrer <i>Solid carbide drill</i> Punta elicoidale in metallo duro für rostfreie Stähle / for stainless steel / per Acciaio Inossidabile	✓	3,0–20,0		214
3 x D	PM-HSS-Spiralbohrer <i>Powder metal drill</i> Punta elicoidale in PM-HSS	X	1,0–13,0		216
5 x D					
5 x D	Vollhartmetall-Spiralbohrer <i>Solid carbide drill</i> Punta elicoidale in metallo duro	X	1,0–20,0		218
5 x D	Vollhartmetall-Spiralbohrer <i>Solid carbide drill</i> Punta elicoidale in metallo duro	✓	1,0–20,0		220
5 x D	Vollhartmetall-Spiralbohrer <i>Solid carbide drill</i> Punta elicoidale in metallo duro für Aluminium / for aluminium / per alluminio diamant beschichtet / diamant coated / rivestito diamante	✓	3,0–20,0		222
5 x D	Vollhartmetall-Spiralbohrer <i>Solid carbide drill</i> Punta elicoidale in metallo duro für rostfreie Stähle / for stainless steel / per Acciaio Inossidabile	✓	1,5–20,0		224
5 x D	Vollhartmetall-Spiralbohrer <i>Solid carbide drill</i> Punta elicoidale in metallo duro für gehärtete Stähle / for hardened steel / per Acciai Temprati	X	3,0–14,0		226

5

VHM- und PM-HSS-Spiralbohrer

Solid carbide drills and powder metal drills
Punte in M.D.I. e punte elicoidali in HSS-PM

Ausführung Design Esecuzione	Bohrertyp Type Tipo	Innenkühlung Through tool coolant Aduzione interna refrigerante	Durchmesser Diameter Diametro [mm]	Abb. Picture Immagine	Seite Page Pagina
7xD					
7xD	Vollhartmetall-Spiralbohrer Solid carbide drill Punta elicoidale in metallo duro	X	1,0–10,0 (unbeschichtet / uncoated / non rivestito)		228
7xD	PM-HSS-Spiralbohrer Powder metal drill Punta elicoidale in PM-HSS	X	2,0–13,0		230
8xD					
8xD	Vollhartmetall-Spiralbohrer Solid carbide drill Punta elicoidale in metallo duro	✓	3,0–12,0		232
8xD	Vollhartmetall-Spiralbohrer Solid carbide drill Punta elicoidale in metallo duro für Aluminium / for aluminium / per alluminio diamant beschichtet / diamant coated / rivestito diamante	✓	3,0–14,0		234
8xD	Vollhartmetall-Spiralbohrer Solid carbide drill Punta elicoidale in metallo duro für rostfreie Stähle / for stainless steel / per Acciaio Inossidabile	✓	3,0–14,0		236
10xD					
10xD	Vollhartmetall-Spiralbohrer Solid carbide drill Punta elicoidale in metallo duro	✓	3,0–14,0		238
15xD					
15xD	Vollhartmetall-Spiralbohrer Solid carbide drill Punta elicoidale in metallo duro	✓	3,0–12,0		239
20xD					
20xD	Vollhartmetall-Spiralbohrer Solid carbide drill Punta elicoidale in metallo duro	✓	3,0–12,0		240

5

Ausführung Design Esecuzione	Bohrertyp Type Tipo	Innenkühlung Through tool coolant Aduzione interna refrigerante	Durchmesser Diameter Diametro [mm]	Abb. Picture Immagine	Seite Page Pagina
Anbohrer und Zentrierer / Spot drills and centre drills / Punte da centro e da contropunta					
NC	Vollhartmetall NC-Anbohrer <i>Solid carbide NC spot drill</i> Punte da centro in MD integrale	X	2,0–20,0		241
NC	PM-HSS NC-Anbohrer <i>Powder metal NC spot drill</i> Punte da centro in HSS-PM	X	2,0–20,0		244
NC	Vollhartmetall Zentrierer <i>Solid carbide centre drill</i> Punte da centro in MD integrale	X	1,0–6,3		247
NC	PM-HSS Zentrierer <i>Powder metal centre drill</i> Punte da centro in HSS-PM	X	1,0–6,3		248

ARNO® Vollhartmetallbohrer für die Hartbearbeitung → Kosten- und Zeitersparnis*ARNO® Solid carbide drills for hard machining → Cost and time saving**ARNO® Punte elicoidali per la foratura di Acciai Temprati → Un risparmio di tempo e denaro*

Als Hartbearbeitung wird die Zerspanung von gehärteten Werkstoffen mit einer Härte von 54 bis 70 HRC (Rockwell) bezeichnet.

Kosten- und Zeitersparnis sind die Hauptgründe für die Wahl des Hartbohrers gehärteter Stähle.

Werden die Bohrungen in den noch ungehärteten Stahl eingebracht, muss das Werkstück zweimal ein- bzw. ausgespannt werden. Zuerst wird das ungehärtete Werkstück eingespannt, um die Bohrungen einzubringen. Anschließend wird es ausgespannt und gehärtet, um wieder (abgesehen von der Verzugsproblematik) eingespannt und zum Beispiel durch Hartfräsen endbearbeitet zu werden.

Bei der Hartbearbeitung wird dieses aufwändige Aus- und wieder Einspannen nach dem ersten Bearbeitungsgang eingespart.

Diese Einsparung des 2. Arbeitsganges führt zu einer deutlichen Ersparnis von Produktionskosten!

Die Vorteile liegen auf der Hand! Optimierte Effizienz der Produktionsprozesse ist das Hauptziel jeder Fertigung!

Materials with a hardness from 54 to 70 HRC (Rockwell) are classed as hard machining.

Cost and time savings would be the main reasons for selecting this drill for hardened steel.

If the hole is drilled in the un-hardened state, the component must be clamped, machined and handled for hardening only to be (not considering any distortion from the hardening process) clamped and possibly finish machined.

If drilled in its hardened condition one machine operation could be saved.

The saving of a 2nd machine operation could save considerable production costs.

The benefits are available, optimized efficiency in the machining process is the main target for any production!

Materiali con durezza da 54 a 70 HRC (Rockwell) vengono classificati come materiali induriti nella scala ISO di identificazione.

La riduzione dei tempi e quindi dei costi è la principale ragione della scelta di utensili appositi per la lavorazione di Acciai Temprati.

Il normale ciclo di lavorazione di un foro temprato prevede una pre-lavorazione del materiale non trattato, il trattamento di indurimento, ed una successiva ripresa del pezzo per la finitura del foro. La fase di ripresa richiede tempo di re-allineamento e di re-lavorazione delle parti da finire, senza considerare eventuali deformazioni dovute ai trattamenti.

Forare direttamente su materiali temprati è da considerarsi un notevole risparmio di tempo.

L'operazione di ripresa non viene quindi considerata, con un notevole risparmio nel tempo ciclo.

I benefici sono alla portata di tutti con i prodotti ARNO. Ottimizzare i processi di lavorazione e ridurre i costi di produzione sono il nostro obiettivo per tutti i nostri clienti!



Vollhartmetall-Spiralbohrer

Solid carbide drills

Punta elicoidale in metallo duro

kurze Ausführung, ohne Innenkühlung

short design, without through tool coolant
versione corta, senza raffreddamento interno

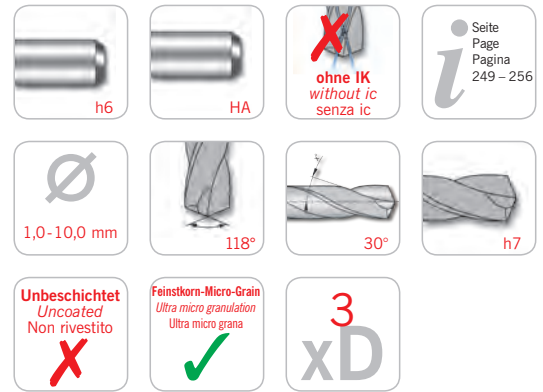
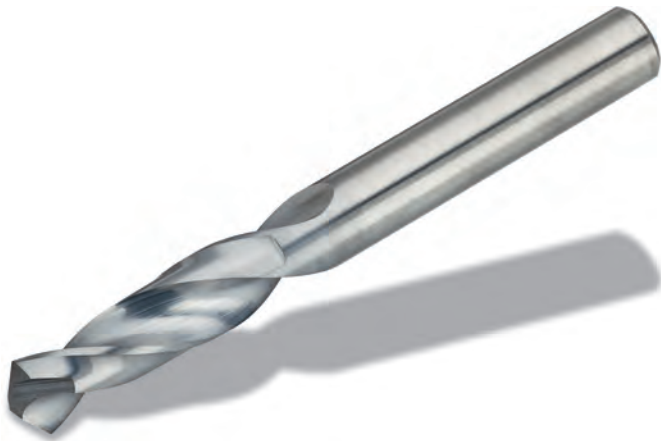

3 x D Ausführung

Execution / Versione

Bezeichnung Designation Articolo	d_1 h7	d_2 h6	l_1	l_2	l_3
SP0100-0030 FK	1,0	1,0	26	6	3,0
SP0110-0033 FK	1,1	1,1	28	7	3,3
SP0120-0036 FK	1,2	1,2	30	8	3,6
SP0130-0039 FK	1,3	1,3	30	8	3,9
SP0140-0042 FK	1,4	1,4	32	9	4,2
SP0150-0045 FK	1,5	1,5	32	9	4,5
SP0160-0048 FK	1,6	1,6	34	10	4,8
SP0170-0051 FK	1,7	1,7	34	10	5,1
SP0180-0054 FK	1,8	1,8	36	11	5,4
SP0190-0057 FK	1,9	1,9	36	11	5,7
SP0200-0060 FK	2,0	2,0	38	12	6,0
SP0210-0063 FK	2,1	2,1	38	12	6,3
SP0220-0066 FK	2,2	2,2	40	13	6,6
SP0230-0069 FK	2,3	2,3	40	13	6,9
SP0240-0072 FK	2,4	2,4	43	14	7,2
SP0250-0075 FK	2,5	2,5	43	14	7,5
SP0260-0078 FK	2,6	2,6	43	14	7,8
SP0270-0081 FK	2,7	2,7	46	16	8,1
SP0280-0084 FK	2,8	2,8	46	16	8,4
SP0290-0087 FK	2,9	2,9	46	16	8,7
SP0300-0090 FK	3,0	3,0	46	16	9,0
SP0310-0093 FK	3,1	3,1	49	18	9,3
SP0320-0096 FK	3,2	3,2	49	18	9,6
SP0330-0099 FK	3,3	3,3	49	18	9,9
SP0340-0102 FK	3,4	3,4	52	20	10,2
SP0350-0105 FK	3,5	3,5	52	20	10,5
SP0360-0108 FK	3,6	3,6	52	20	10,8
SP0370-0111 FK	3,7	3,7	52	20	11,1
SP0380-0114 FK	3,8	3,8	52	20	11,4
SP0390-0117 FK	3,9	3,9	55	22	11,7
SP0400-0120 FK	4,0	4,0	55	22	12,0
SP0410-0123 FK	4,1	4,1	55	22	12,3
SP0420-0126 FK	4,2	4,2	55	22	12,6
SP0430-0129 FK	4,3	4,3	58	24	12,9
SP0440-0132 FK	4,4	4,4	58	24	13,2
SP0450-0135 FK	4,5	4,5	58	24	13,5
SP0460-0138 FK	4,6	4,6	58	24	13,8
SP0470-0141 FK	4,7	4,7	58	24	14,1
SP0480-0144 FK	4,8	4,8	62	26	14,4
SP0490-0147 FK	4,9	4,9	62	26	14,7
SP0500-0150 FK	5,0	5,0	62	26	15,0
SP0510-0153 FK	5,1	5,1	62	26	15,3
SP0520-0156 FK	5,2	5,2	62	26	15,6
SP0530-0159 FK	5,3	5,3	62	26	15,9

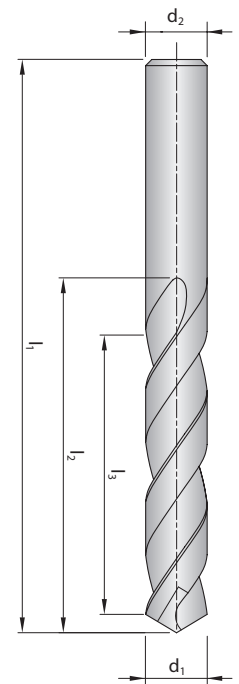

Hinweis: Auch mit Zylinderschaft-Mitnahmefläche nach DIN 6535HB erhältlich (Lieferzeit ca. 1 Woche).

Reference: Also available with flat to DIN 6535HB (approx. 1 week delivery time).

Nota: Disponibili anche con gambo DIN 6535HB con piano di bloccaggio (consegna circa 5gg).

5

3 x D Ausführung Execution / Versione

Bezeichnung Designation Articolo	d ₁ h7	d ₂ h6	l ₁	l ₂	l ₃
SP0540-0162 FK	5,4	5,4	66	28	16,2
SP0550-0165 FK	5,5	5,5	66	28	16,5
SP0560-0168 FK	5,6	5,6	66	28	16,8
SP0570-0171 FK	5,7	5,7	66	28	17,1
SP0580-0174 FK	5,8	5,8	66	28	17,4
SP0590-0177 FK	5,9	5,9	66	28	17,7
SP0600-0180 FK	6,0	6,0	66	28	18,0
SP0610-0183 FK	6,1	6,1	70	31	18,3
SP0620-0186 FK	6,2	6,2	70	31	18,6
SP0630-0189 FK	6,3	6,3	70	31	18,9
SP0640-0192 FK	6,4	6,4	70	31	19,2
SP0650-0195 FK	6,5	6,5	70	31	19,5
SP0660-0198 FK	6,6	6,6	70	31	19,8
SP0670-0201 FK	6,7	6,7	70	31	20,1
SP0680-0204 FK	6,8	6,8	74	34	20,4
SP0690-0207 FK	6,9	6,9	74	34	20,7
SP0700-0210 FK	7,0	7,0	74	34	21,0
SP0710-0213 FK	7,1	7,1	74	34	21,3
SP0720-0216 FK	7,2	7,2	74	34	21,6
SP0730-0219 FK	7,3	7,3	74	34	21,9
SP0740-0222 FK	7,4	7,4	74	34	22,2
SP0750-0225 FK	7,5	7,5	74	34	22,5
SP0760-0228 FK	7,6	7,6	79	37	22,8
SP0770-0231 FK	7,7	7,7	79	37	23,1
SP0780-0234 FK	7,8	7,8	79	37	23,4
SP0790-0237 FK	7,9	7,9	79	37	23,7
SP0800-0240 FK	8,0	8,0	79	37	24,0
SP0810-0243 FK	8,1	8,1	79	37	24,3
SP0820-0246 FK	8,2	8,2	79	37	24,6
SP0830-0249 FK	8,3	8,3	79	37	24,9
SP0840-0252 FK	8,4	8,4	79	37	25,2
SP0850-0255 FK	8,5	8,5	79	37	25,5
SP0860-0258 FK	8,6	8,6	84	40	25,8
SP0870-0261 FK	8,7	8,7	84	40	26,1
SP0880-0264 FK	8,8	8,8	84	40	26,4
SP0890-0267 FK	8,9	8,9	84	40	26,7
SP0900-0270 FK	9,0	9,0	84	40	27,0
SP0910-0273 FK	9,1	9,1	84	40	27,3
SP0920-0276 FK	9,2	9,2	84	40	27,6
SP0930-0279 FK	9,3	9,3	84	40	27,9
SP0940-0282 FK	9,4	9,4	84	40	28,2
SP0950-0285 FK	9,5	9,5	84	40	28,5
SP0960-0288 FK	9,6	9,6	89	43	28,8
SP0970-0291 FK	9,7	9,7	89	43	29,1
SP0980-0294 FK	9,8	9,8	89	43	29,4
SP0990-0297 FK	9,9	9,9	89	43	29,7
SP1000-0300 FK	10,0	10,0	89	43	30,0

Vollhartmetall-Spiralbohrer

Solid carbide drills

Punta elicoidale in metallo duro

kurze Ausführung, ohne Innenkühlung

short design, without through tool coolant

versione corta, senza raffreddamento interno

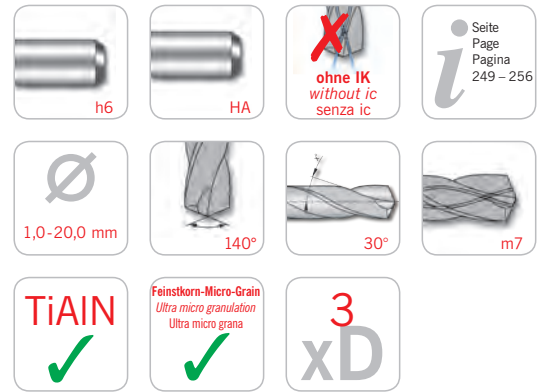

3 x D Ausführung

Execution / Versione

Bezeichnung Designation Articolo	d ₁ m7	d ₂ h6	l ₁	l ₂	l ₃
SP0100-0030	1,0	3	45	7	3,0
SP0110-0033	1,1	3	45	7	3,3
SP0120-0036	1,2	3	45	7	3,6
SP0130-0039	1,3	3	45	7	3,9
SP0140-0042	1,4	3	45	7	4,2
SP0150-0045	1,5	3	55	14	4,5
SP0160-0048	1,6	3	55	14	4,8
SP0170-0051	1,7	3	55	14	5,1
SP0180-0054	1,8	3	55	14	5,4
SP0190-0057	1,9	4	55	14	5,7
SP0200-0060	2,0	4	55	20	6,0
SP0210-0063	2,1	4	55	20	6,3
SP0220-0066	2,2	4	55	20	6,6
SP0230-0069	2,3	4	55	20	6,9
SP0240-0072	2,4	4	55	20	7,2
SP0250-0075	2,5	4	55	20	7,5
SP0260-0078	2,6	4	55	20	7,8
SP0270-0081	2,7	4	55	20	8,1
SP0280-0084	2,8	4	55	20	8,4
SP0290-0087	2,9	4	55	20	8,7
SP0300-0090	3,0	6	62	20	9,0
SP0310-0093	3,1	6	62	20	9,3
SP0320-0096	3,2	6	62	20	9,6
SP0330-0099	3,3	6	62	20	9,9
SP0340-0102	3,4	6	62	20	10,2
SP0350-0105	3,5	6	62	20	10,5
SP0360-0108	3,6	6	62	20	10,8
SP0370-0111	3,7	6	62	20	11,1
SP0380-0114	3,8	6	66	24	11,4
SP0390-0117	3,9	6	66	24	11,7
SP0400-0120	4,0	6	66	24	12,0
SP0408-0122	4,08	6	66	24	12,2
SP0410-0123	4,1	6	66	24	12,3
SP0420-0126	4,2	6	66	24	12,6
SP0425-0128	4,25	6	66	24	12,8
SP0430-0129	4,3	6	66	24	12,9
SP0440-0132	4,4	6	66	24	13,2
SP0450-0135	4,5	6	66	24	13,5
SP0460-0138	4,6	6	66	24	13,8
SP0470-0141	4,7	6	66	24	14,1
SP0480-0144	4,8	6	66	28	14,4
SP0490-0147	4,9	6	66	28	14,7
SP0497-0150	4,97	6	66	28	15,0
SP0500-0150	5,0	6	66	28	15,0

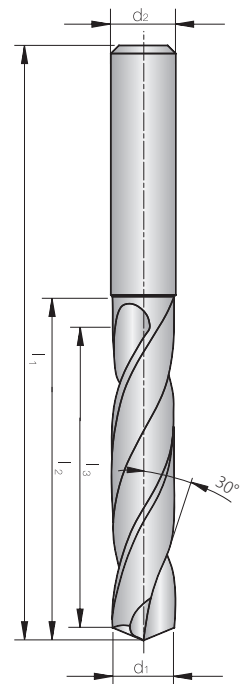

5

3 x D Ausführung Execution / Versione

Bezeichnung Designation Articolo	d ₁ m7	d ₂ h6	l ₁	l ₂	l ₃
SP0509-0153	5,09	6	66	28	15,3
SP0510-0153	5,1	6	66	28	15,3
SP0520-0156	5,2	6	66	28	15,6
SP0530-0159	5,3	6	66	28	15,9
SP0540-0162	5,4	6	66	28	16,2
SP0550-0165	5,5	6	66	28	16,5
SP0560-0168	5,6	6	66	28	16,8
SP0570-0171	5,7	6	66	28	17,1
SP0580-0174	5,8	6	66	28	17,4
SP0590-0177	5,9	6	66	28	17,7
SP0600-0180	6,0	6	66	28	18,0
SP0609-0183	6,09	8	79	34	18,3
SP0610-0183	6,1	8	79	34	18,3
SP0620-0186	6,2	8	79	34	18,6
SP0630-0189	6,3	8	79	34	18,9
SP0640-0192	6,4	8	79	34	19,2
SP0650-0195	6,5	8	79	34	19,5
SP0655-0197	6,55	8	79	34	19,7
SP0660-0198	6,6	8	79	34	19,8
SP0670-0201	6,7	8	79	34	20,1
SP0680-0204	6,8	8	79	34	20,4
SP0690-0207	6,9	8	79	34	20,7
SP0700-0210	7,0	8	79	34	21,0
SP0710-0213	7,1	8	79	41	21,3
SP0720-0216	7,2	8	79	41	21,6
SP0730-0219	7,3	8	79	41	21,9
SP0740-0222	7,4	8	79	41	22,2
SP0750-0225	7,5	8	79	41	22,5
SP0760-0228	7,6	8	79	41	22,8
SP0770-0231	7,7	8	79	41	23,1
SP0780-0234	7,8	8	79	41	23,4
SP0790-0237	7,9	8	79	41	23,7
SP0800-0240	8,0	8	79	41	24,0
SP0810-0243	8,1	10	89	47	24,3
SP0820-0246	8,2	10	89	47	24,6
SP0830-0249	8,3	10	89	47	24,9
SP0840-0252	8,4	10	89	47	25,2
SP0850-0255	8,5	10	89	47	25,5
SP0860-0258	8,6	10	89	47	25,8
SP0870-0261	8,7	10	89	47	26,1
SP0880-0264	8,8	10	89	47	26,4
SP0890-0267	8,9	10	89	47	26,7
SP0900-0270	9,0	10	89	47	27,0
SP0910-0273	9,1	10	89	47	27,3
SP0920-0276	9,2	10	89	47	27,6
SP0930-0279	9,3	10	89	47	27,9
SP0940-0282	9,4	10	89	47	28,2
SP0950-0285	9,5	10	89	47	28,5
SP0960-0288	9,6	10	89	47	28,8
SP0970-0291	9,7	10	89	47	29,1
SP0980-0294	9,8	10	89	47	29,4
SP0990-0297	9,9	10	89	47	29,7
SP1000-0300	10,0	10	89	47	30,0
SP1010-0303	10,1	12	102	55	30,3
SP1020-0306	10,2	12	102	55	30,6
SP1030-0309	10,3	12	102	55	30,9
SP1040-0312	10,4	12	102	55	31,2
SP1050-0315	10,5	12	102	55	31,5
SP1060-0318	10,6	12	102	55	31,8
SP1070-0321	10,7	12	102	55	32,1

Bezeichnung Designation Articolo	d ₁ m7	d ₂ h6	l ₁	l ₂	l ₃
SP1080-0324	10,8	12	102	55	32,4
SP1090-0327	10,9	12	102	55	32,7
SP1100-0330	11,0	12	102	55	33,0
SP1110-0333	11,1	12	102	55	33,3
SP1120-0336	11,2	12	102	55	33,6
SP1130-0339	11,3	12	102	55	33,9
SP1140-0342	11,4	12	102	55	34,2
SP1150-0345	11,5	12	102	55	34,5
SP1160-0348	11,6	12	102	55	34,8
SP1170-0351	11,7	12	102	55	35,1
SP1180-0354	11,8	12	102	55	35,4
SP1190-0357	11,9	12	102	55	35,7
SP1200-0360	12,0	12	102	55	36,0
SP1230-0369	12,3	14	107	60	36,9
SP1250-0375	12,5	14	107	60	37,5
SP1280-0384	12,8	14	107	60	38,4
SP1300-0390	13,0	14	107	60	39,0
SP1350-0405	13,5	14	107	60	40,5
SP1380-0414	13,8	14	107	60	41,4
SP1400-0420	14,0	14	107	60	42,0
SP1450-0435	14,5	16	115	65	43,5
SP1480-0444	14,8	16	115	65	44,4
SP1500-0450	15,0	16	115	65	45,0
SP1550-0465	15,5	16	115	65	46,5
SP1580-0474	15,8	16	115	65	47,4
SP1600-0480	16,0	16	115	65	48,0
SP1650-0495	16,5	18	123	73	49,5
SP1680-0504	16,8	18	123	73	50,4
SP1700-0510	17,0	18	123	73	51,0
SP1750-0525	17,5	18	123	73	52,5
SP1780-0534	17,8	18	123	73	53,4
SP1800-0540	18,0	18	123	73	54,0
SP1850-0555	18,5	20	131	79	55,5
SP1880-0564	18,8	20	131	79	56,4
SP1900-0570	19,0	20	131	79	57,0
SP1950-0585	19,5	20	131	79	58,5
SP1980-0594	19,8	20	131	79	59,4
SP2000-0600	20,0	20	131	79	60,0



Vollhartmetall-Spiralbohrer

Solid carbide drills

Punta elicoidale in metallo duro

kurze Ausführung, mit Innenkühlung

short design, with through tool coolant

versione corta, con raffreddamento interno

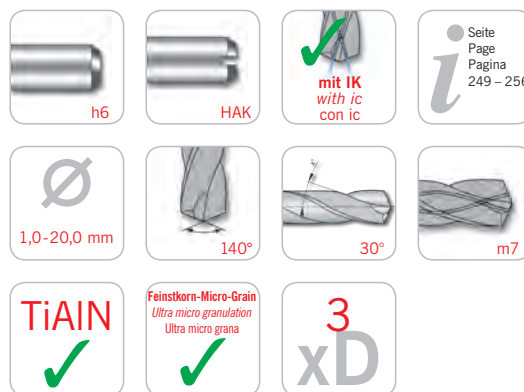

3 x D Ausführung

Execution / Versione

Bezeichnung Designation Articolo	d ₁ m7	d ₂ h6	l ₁	l ₂	l ₃
SPC0100-0030	1,0	3	45	7	3,0
SPC0110-0033	1,1	3	45	7	3,3
SPC0120-0036	1,2	3	45	7	3,6
SPC0130-0039	1,3	3	45	7	3,9
SPC0140-0042	1,4	3	45	7	4,2
SPC0150-0045	1,5	3	55	14	4,5
SPC0160-0048	1,6	3	55	14	4,8
SPC0170-0051	1,7	3	55	14	5,1
SPC0180-0054	1,8	3	55	14	5,4
SPC0190-0057	1,9	3	55	14	5,7
SPC0200-0060	2,0	4	55	20	6,0
SPC0210-0063	2,1	4	55	20	6,3
SPC0220-0066	2,2	4	55	20	6,6
SPC0230-0069	2,3	4	55	20	6,9
SPC0240-0072	2,4	4	55	20	7,2
SPC0250-0075	2,5	4	55	20	7,5
SPC0258-00774	2,58	4	55	20	7,74
SPC0260-0078	2,6	4	55	20	7,8
SPC0270-0081	2,7	4	55	20	8,1
SPC0280-0084	2,8	4	55	20	8,4
SPC0290-0087	2,9	4	55	20	8,7
SPC0300-0090	3,0	6	62	20	9,0
SPC0310-0093	3,1	6	62	20	9,3
SPC0320-0096	3,2	6	62	20	9,6
SPC0325-0098	3,25	6	62	20	9,8
SPC0330-0099	3,3	6	62	20	9,9
SPC0340-0102	3,4	6	62	20	10,2
SPC0350-0105	3,5	6	62	20	10,5
SPC0360-0108	3,6	6	62	20	10,8
SPC0370-0111	3,7	6	62	20	11,1
SPC0380-0114	3,8	6	66	24	11,4
SPC0390-0117	3,9	6	66	24	11,7
SPC0400-0120	4,0	6	66	24	12,0
SPC0410-0123	4,1	6	66	24	12,3
SPC0415-0125	4,15	6	66	24	12,5
SPC0420-0126	4,2	6	66	24	12,6
SPC0430-0129	4,3	6	66	24	12,9
SPC0440-0132	4,4	6	66	24	13,2
SPC0450-0135	4,5	6	66	24	13,5
SPC0460-0138	4,6	6	66	24	13,8
SPC0465-0140	4,65	6	66	24	14,0
SPC0470-0141	4,7	6	66	24	14,1
SPC0480-0144	4,8	6	66	28	14,4
SPC0490-0147	4,9	6	66	28	14,7

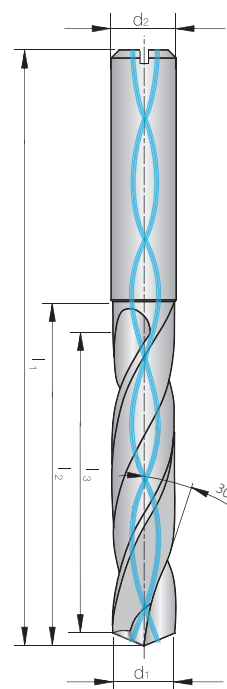

5

3 x D Ausführung Execution / Versione

Bezeichnung Designation Articolo	d ₁ m7	d ₂ h6	l ₁	l ₂	l ₃
SPC0500-0150	5,0	6	66	28	15,0
SPC0510-0153	5,1	6	66	28	15,3
SPC0520-0156	5,2	6	66	28	15,6
SPC0530-0159	5,3	6	66	28	15,9
SPC0540-0162	5,4	6	66	28	16,2
SPC0550-0165	5,5	6	66	28	16,5
SPC0555-0167	5,55	6	66	28	16,7
SPC0560-0168	5,6	6	66	28	16,8
SPC0570-0171	5,7	6	66	28	17,1
SPC0580-0174	5,8	6	66	28	17,4
SPC0590-0177	5,9	6	66	28	17,7
SPC0600-0180	6,0	6	66	28	18,0
SPC0610-0183	6,1	8	79	34	18,3
SPC0620-0186	6,2	8	79	34	18,6
SPC0630-0189	6,3	8	79	34	18,9
SPC0640-0192	6,4	8	79	34	19,2
SPC0650-0195	6,5	8	79	34	19,5
SPC0655-0197	6,55	8	79	34	19,7
SPC0660-0198	6,6	8	79	34	19,8
SPC0670-0201	6,7	8	79	34	20,1
SPC0680-0204	6,8	8	79	34	20,4
SPC0690-0207	6,9	8	79	34	20,7
SPC0700-0210	7,0	8	79	34	21,0
SPC0710-0213	7,1	8	79	41	21,3
SPC0720-0216	7,2	8	79	41	21,6
SPC0730-0219	7,3	8	79	41	21,9
SPC0740-0222	7,4	8	79	41	22,2
SPC0745-0224	7,45	8	79	41	22,4
SPC0750-0225	7,5	8	79	41	22,5
SPC0760-0228	7,6	8	79	41	22,8
SPC0770-0231	7,7	8	79	41	23,1
SPC0780-0234	7,8	8	79	41	23,4
SPC0790-0237	7,9	8	79	41	23,7
SPC0800-0240	8,0	8	79	41	24,0
SPC0810-0243	8,1	10	89	47	24,3
SPC0820-0246	8,2	10	89	47	24,6
SPC0830-0249	8,3	10	89	47	24,9
SPC0840-0252	8,4	10	89	47	25,2
SPC0850-0255	8,5	10	89	47	25,5
SPC0860-0258	8,6	10	89	47	25,8
SPC0870-0261	8,7	10	89	47	26,1
SPC0880-0264	8,8	10	89	47	26,4
SPC0890-0267	8,9	10	89	47	26,7
SPC0900-0270	9,0	10	89	47	27,0
SPC0910-0273	9,1	10	89	47	27,3
SPC0920-0276	9,2	10	89	47	27,6
SPC0925-0278	9,25	10	89	47	27,8
SPC0930-0279	9,3	10	89	47	27,9
SPC0940-0282	9,4	10	89	47	28,2
SPC0950-0285	9,5	10	89	47	28,5
SPC0960-0288	9,6	10	89	47	28,8
SPC0970-0291	9,7	10	89	47	29,1
SPC0980-0294	9,8	10	89	47	29,4
SPC0990-0297	9,9	10	89	47	29,7
SPC1000-0300	10,0	10	89	47	30,0
SPC1010-0303	10,1	12	102	55	30,3
SPC1020-0306	10,2	12	102	55	30,6
SPC1025-0308	10,25	12	102	55	30,8
SPC1030-0309	10,3	12	102	55	30,9
SPC1040-0312	10,4	12	102	55	31,2

Bezeichnung Designation Articolo	d ₁ m7	d ₂ h6	l ₁	l ₂	l ₃
SPC1050-0315	10,5	12	102	55	31,5
SPC1060-0318	10,6	12	102	55	31,8
SPC1070-0321	10,7	12	102	55	32,1
SPC1080-0324	10,8	12	102	55	32,4
SPC1090-0327	10,9	12	102	55	32,7
SPC1100-0330	11,0	12	102	55	33,0
SPC1110-0333	11,1	12	102	55	33,3
SPC1120-0336	11,2	12	102	55	33,6
SPC1130-0339	11,3	12	102	55	33,9
SPC1140-0342	11,4	12	102	55	34,2
SPC1150-0345	11,5	12	102	55	34,5
SPC1160-0348	11,6	12	102	55	34,8
SPC1170-0351	11,7	12	102	55	35,1
SPC1180-0354	11,8	12	102	55	35,4
SPC1190-0357	11,9	12	102	55	35,7
SPC1200-0360	12,0	12	102	55	36,0
SPC1250-0375	12,5	14	107	60	37,5
SPC1280-0384	12,8	14	107	60	38,4
SPC1300-0390	13,0	14	107	60	39,0
SPC1310-0393	13,1	14	107	60	39,3
SPC1350-0405	13,5	14	107	60	40,5
SPC1380-0414	13,8	14	107	60	41,4
SPC1400-0420	14,0	14	107	60	42,0
SPC1420-0426	14,2	16	115	65	42,6
SPC1450-0435	14,5	16	115	65	43,5
SPC1500-0450	15,0	16	115	65	45,0
SPC1510-0453	15,1	16	115	65	45,3
SPC1550-0465	15,5	16	115	65	46,5
SPC1580-0474	15,8	16	115	65	47,4
SPC1600-0480	16,0	16	115	65	48,0
SPC1650-0495	16,5	18	123	73	49,5
SPC1680-0504	16,8	18	123	73	50,4
SPC1690-0507	16,9	18	123	73	50,7
SPC1700-0510	17,0	18	123	73	51,0
SPC1750-0525	17,5	18	123	73	52,5
SPC1780-0534	17,8	18	123	73	53,4
SPC1800-0540	18,0	18	123	73	54,0
SPC1850-0555	18,5	20	131	79	55,5
SPC1880-0564	18,8	20	131	79	56,4
SPC1890-0567	18,9	20	131	79	56,7
SPC1900-0570	19,0	20	131	79	57,0
SPC1950-0585	19,5	20	131	79	58,5
SPC1980-0594	19,8	20	131	79	59,4
SPC2000-0600	20,0	20	131	79	60,0

Vollhartmetall-Spiralbohrer

kurze Ausführung, mit Innenkühlung, Diamant beschichtet













Solid carbide drills

short design, with through tool coolant, diamond coated

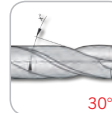
Punta elicoidale in metallo duro

versione corta, con raffreddamento interno, rivestita Diamante DLC



 h6	 HAK	 mit IK with ic con ic	 Seite Page Pagina 249 - 256
 3,0 - 20,0 mm	 118°	 30°	 m7
 DIAMANT DIAMANTE	 Feinstkorn-Micro-Grain Ultra micro granulation Ultra micro grana	 ALU	 3 xD

3 x D Ausführung für Aluminium

Execution for aluminium

Versione per Alluminio e leghe non ferrose

Bezeichnung Designation Articolo	d ₁ m7	d ₂ h6	l ₁	l ₂	l ₃
SPC0300-0090-ALU	3,0	6	62	20	9,0
SPC0310-0093-ALU	3,1	6	62	20	9,3
SPC0320-0096-ALU	3,2	6	62	20	9,6
SPC0330-0099-ALU	3,3	6	62	20	9,9
SPC0340-0102-ALU	3,4	6	62	20	10,2
SPC0350-0105-ALU	3,5	6	62	20	10,5
SPC0360-0108-ALU	3,6	6	62	20	10,8
SPC0370-0111-ALU	3,7	6	62	20	11,1
SPC0380-0114-ALU	3,8	6	66	24	11,4
SPC0390-0117-ALU	3,9	6	66	24	11,7
SPC0400-0120-ALU	4,0	6	66	24	12,0
SPC0410-0123-ALU	4,1	6	66	24	12,3
SPC0420-0126-ALU	4,2	6	66	24	12,6
SPC0430-0129-ALU	4,3	6	66	24	12,9
SPC0440-0132-ALU	4,4	6	66	24	13,2
SPC0450-0135-ALU	4,5	6	66	24	13,5
SPC0460-0138-ALU	4,6	6	66	24	13,8
SPC0470-0141-ALU	4,7	6	66	24	14,1
SPC0480-0144-ALU	4,8	6	66	28	14,4
SPC0490-0147-ALU	4,9	6	66	28	14,7
SPC0500-0150-ALU	5,0	6	66	28	15,0
SPC0510-0153-ALU	5,1	6	66	28	15,3
SPC0520-0156-ALU	5,2	6	66	28	15,6
SPC0530-0159-ALU	5,3	6	66	28	15,9
SPC0540-0162-ALU	5,4	6	66	28	16,2
SPC0550-0165-ALU	5,5	6	66	28	16,5
SPC0560-0168-ALU	5,6	6	66	28	16,8
SPC0570-0171-ALU	5,7	6	66	28	17,1
SPC0580-0174-ALU	5,8	6	66	28	17,4
SPC0590-0177-ALU	5,9	6	66	28	17,7
SPC0600-0180-ALU	6,0	6	66	28	18,0
SPC0610-0183-ALU	6,1	8	79	34	18,3
SPC0620-0186-ALU	6,2	8	79	34	18,6
SPC0630-0189-ALU	6,3	8	79	34	18,9
SPC0640-0192-ALU	6,4	8	79	34	19,2
SPC0650-0195-ALU	6,5	8	79	34	19,5
SPC0660-0198-ALU	6,6	8	79	34	19,8
SPC0670-0201-ALU	6,7	8	79	34	20,1
SPC0680-0204-ALU	6,8	8	79	34	20,4
SPC0690-0207-ALU	6,9	8	79	34	20,7
SPC0700-0210-ALU	7,0	8	79	34	21,0
SPC0710-0213-ALU	7,1	8	79	41	21,3

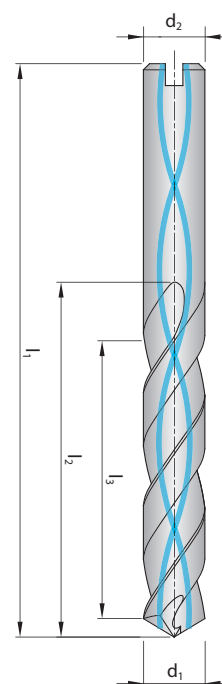

5

3 x D Ausführung für Aluminium

Execution for aluminium

Versione per Alluminio e leghe non ferrose

Bezeichnung Designation Articolo	d ₁ m7	d ₂ h6	l ₁	l ₂	l ₃
SPC0720-0216-ALU	7,2	8	79	41	21,6
SPC0730-0219-ALU	7,3	8	79	41	21,9
SPC0740-0222-ALU	7,4	8	79	41	22,2
SPC0750-0225-ALU	7,5	8	79	41	22,5
SPC0760-0228-ALU	7,6	8	79	41	22,8
SPC0770-0231-ALU	7,7	8	79	41	23,1
SPC0780-0234-ALU	7,8	8	79	41	23,4
SPC0790-0237-ALU	7,9	8	79	41	23,7
SPC0800-0240-ALU	8,0	10	79	41	24,0
SPC0810-0243-ALU	8,1	10	89	47	24,3
SPC0820-0246-ALU	8,2	10	89	47	24,6
SPC0830-0249-ALU	8,3	10	89	47	24,9
SPC0840-0252-ALU	8,4	10	89	47	25,2
SPC0850-0255-ALU	8,5	10	89	47	25,5
SPC0860-0258-ALU	8,6	10	89	47	25,8
SPC0870-0261-ALU	8,7	10	89	47	26,1
SPC0880-0264-ALU	8,8	10	89	47	26,4
SPC0890-0267-ALU	8,9	10	89	47	26,7
SPC0900-0270-ALU	9,0	10	89	47	27,0
SPC0910-0273-ALU	9,1	10	89	47	27,3
SPC0920-0276-ALU	9,2	10	89	47	27,6
SPC0930-0279-ALU	9,3	10	89	47	27,9
SPC0940-0282-ALU	9,4	10	89	47	28,2
SPC0950-0285-ALU	9,5	10	89	47	28,5
SPC0960-0288-ALU	9,6	10	89	47	28,8
SPC0970-0291-ALU	9,7	10	89	47	29,1
SPC0980-0294-ALU	9,8	10	89	47	29,4
SPC0990-0297-ALU	9,9	10	89	55	29,7
SPC1000-0300-ALU	10,0	10	89	55	30,0
SPC1010-0303-ALU	10,1	12	102	55	30,3
SPC1020-0306-ALU	10,2	12	102	55	30,6
SPC1030-0309-ALU	10,3	12	102	55	30,9
SPC1040-0312-ALU	10,4	12	102	55	31,2
SPC1050-0315-ALU	10,5	12	102	55	31,5
SPC1060-0318-ALU	10,6	12	102	55	31,8
SPC1070-0321-ALU	10,7	12	102	55	32,1
SPC1080-0324-ALU	10,8	12	102	55	32,4
SPC1090-0327-ALU	10,9	12	102	55	32,7
SPC1100-0330-ALU	11,0	12	102	55	33,0
SPC1110-0333-ALU	11,1	12	102	55	33,3
SPC1120-0336-ALU	11,2	12	102	55	33,6
SPC1130-0339-ALU	11,3	12	102	55	33,9
SPC1140-0342-ALU	11,4	12	102	55	34,2
SPC1150-0345-ALU	11,5	12	102	55	34,5
SPC1160-0348-ALU	11,6	12	102	55	34,8
SPC1170-0351-ALU	11,7	12	102	55	35,1
SPC1180-0354-ALU	11,8	12	102	55	35,4
SPC1190-0357-ALU	11,9	12	102	55	35,7
SPC1200-0360-ALU	12,0	12	102	55	36,0
SPC1250-0375-ALU	12,5	14	107	60	37,5
SPC1280-0384-ALU	12,8	14	107	60	38,4
SPC1300-0390-ALU	13,0	14	107	60	39,0
SPC1350-0405-ALU	13,5	14	107	60	40,5
SPC1380-0414-ALU	13,8	14	107	60	41,4
SPC1400-0420-ALU	14,0	14	107	60	42,0
SPC1420-0426-ALU	14,2	16	115	65	42,6
SPC1450-0435-ALU	14,5	16	115	65	43,5
SPC1500-0450-ALU	15,0	16	115	65	45,0

Bezeichnung Designation Articolo	d ₁ m7	d ₂ h6	l ₁	l ₂	l ₃
SPC1550-0465-ALU	15,5	16	115	65	46,5
SPC1580-0474-ALU	15,8	16	115	65	47,4
SPC1600-0480-ALU	16,0	16	115	65	48,0
SPC1650-0495-ALU	16,5	18	123	73	49,5
SPC1680-0504-ALU	16,8	18	123	73	50,4
SPC1700-0510-ALU	17,0	18	123	73	51,0
SPC1750-0525-ALU	17,5	18	123	73	52,5
SPC1780-0534-ALU	17,8	18	123	73	53,4
SPC1800-0540-ALU	18,0	18	123	73	54,0
SPC1850-0555-ALU	18,5	20	131	79	55,5
SPC1880-0564-ALU	18,8	20	131	79	56,4
SPC1900-0570-ALU	19,0	20	131	79	57,0
SPC1950-0585-ALU	19,5	20	131	79	58,5
SPC1980-0594-ALU	19,8	20	131	79	59,4
SPC2000-0600-ALU	20,0	20	131	79	60,0



Vollhartmetall-Spiralbohrer

Solid carbide drills

Punta elicoidale in metallo duro

kurze Ausführung, mit Innenkühlung

short design, with through tool coolant

versione corta, con raffreddamento interno



h6	HAK	mit IK with ic con ic	Seite Page Pagina 249 - 256
3,0 - 20,0 mm	140°	30°	m7
TiAlN	Feinstkorn-Micro-Grain Ultra micro granulation Ultra micro grana	VA	3 xD

3 x D Ausführung für rostfreie Stähle

Execution for stainless steel

Versione per Acciai Inossidabili

Bezeichnung Designation Articolo	d ₁ m7	d ₂ h6	l ₁	l ₂	l ₃
SPC0300-0090-VA	3,0	6	62	20	9,0
SPC0310-0093-VA	3,1	6	62	20	9,3
SPC0320-0096-VA	3,2	6	62	20	9,6
SPC0330-0099-VA	3,3	6	62	20	9,9
SPC0340-0102-VA	3,4	6	62	20	10,2
SPC0350-0105-VA	3,5	6	62	20	10,5
SPC0360-0108-VA	3,6	6	62	20	10,8
SPC0370-0111-VA	3,7	6	62	20	11,1
SPC0380-0114-VA	3,8	6	66	24	11,4
SPC0390-0117-VA	3,9	6	66	24	11,7
SPC0400-0120-VA	4,0	6	66	24	12,0
SPC0410-0123-VA	4,1	6	66	24	12,3
SPC0420-0126-VA	4,2	6	66	24	12,6
SPC0430-0129-VA	4,3	6	66	24	12,9
SPC0440-0132-VA	4,4	6	66	24	13,2
SPC0450-0135-VA	4,5	6	66	24	13,5
SPC0460-0138-VA	4,6	6	66	24	13,8
SPC0470-0141-VA	4,7	6	66	24	14,1
SPC0480-0144-VA	4,8	6	66	28	14,4
SPC0490-0147-VA	4,9	6	66	28	14,7
SPC0500-0150-VA	5,0	6	66	28	15,0
SPC0510-0153-VA	5,1	6	66	28	15,3
SPC0520-0156-VA	5,2	6	66	28	15,6
SPC0530-0159-VA	5,3	6	66	28	15,9
SPC0540-0162-VA	5,4	6	66	28	16,2
SPC0550-0165-VA	5,5	6	66	28	16,5
SPC0560-0168-VA	5,6	6	66	28	16,8
SPC0570-0171-VA	5,7	6	66	28	17,1
SPC0580-0174-VA	5,8	6	66	28	17,4
SPC0590-0177-VA	5,9	6	66	28	17,7
SPC0600-0180-VA	6,0	6	66	28	18,0
SPC0610-0183-VA	6,1	8	79	34	18,3
SPC0620-0186-VA	6,2	8	79	34	18,6
SPC0630-0189-VA	6,3	8	79	34	18,9
SPC0640-0192-VA	6,4	8	79	34	19,2
SPC0650-0195-VA	6,5	8	79	34	19,5
SPC0660-0198-VA	6,6	8	79	34	19,8
SPC0670-0201-VA	6,7	8	79	34	20,1
SPC0680-0204-VA	6,8	8	79	34	20,4
SPC0690-0207-VA	6,9	8	79	34	20,7
SPC0700-0210-VA	7,0	8	79	34	21,0
SPC0710-0213-VA	7,1	8	79	41	21,3

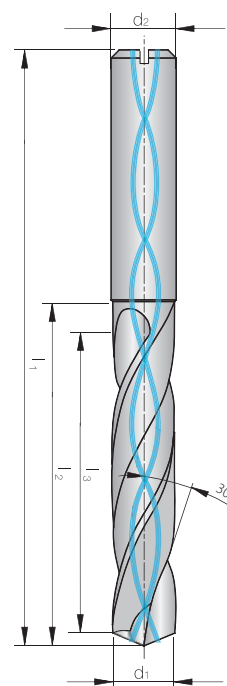

5

3 x D Ausführung für rostfreie Stähle

Execution for stainless steel

Versione per Acciai Inossidabili

Bezeichnung Designation Articolo	d ₁ m7	d ₂ h6	l ₁	l ₂	l ₃
SPC0720-0216-VA	7,2	8	79	41	21,6
SPC0730-0219-VA	7,3	8	79	41	21,9
SPC0740-0222-VA	7,4	8	79	41	22,2
SPC0750-0225-VA	7,5	8	79	41	22,5
SPC0760-0228-VA	7,6	8	79	41	22,8
SPC0770-0231-VA	7,7	8	79	41	23,1
SPC0780-0234-VA	7,8	8	79	41	23,4
SPC0790-0237-VA	7,9	8	79	41	23,7
SPC0800-0240-VA	8,0	8	79	41	24,0
SPC0810-0243-VA	8,1	10	89	47	24,3
SPC0820-0246-VA	8,2	10	89	47	24,6
SPC0830-0249-VA	8,3	10	89	47	24,9
SPC0840-0252-VA	8,4	10	89	47	25,2
SPC0850-0255-VA	8,5	10	89	47	25,5
SPC0860-0258-VA	8,6	10	89	47	25,8
SPC0870-0261-VA	8,7	10	89	47	26,1
SPC0880-0264-VA	8,8	10	89	47	26,4
SPC0890-0267-VA	8,9	10	89	47	26,7
SPC0900-0270-VA	9,0	10	89	47	27,0
SPC0910-0273-VA	9,1	10	89	47	27,3
SPC0920-0276-VA	9,2	10	89	47	27,6
SPC0930-0279-VA	9,3	10	89	47	27,9
SPC0940-0282-VA	9,4	10	89	47	28,2
SPC0950-0285-VA	9,5	10	89	47	28,5
SPC0960-0288-VA	9,6	10	89	47	28,8
SPC0970-0291-VA	9,7	10	89	47	29,1
SPC0980-0294-VA	9,8	10	89	47	29,4
SPC0990-0297-VA	9,9	10	89	47	29,7
SPC1000-0300-VA	10,0	10	89	47	30,0
SPC1010-0303-VA	10,1	12	102	55	30,3
SPC1020-0306-VA	10,2	12	102	55	30,6
SPC1030-0309-VA	10,3	12	102	55	30,9
SPC1040-0312-VA	10,4	12	102	55	31,2
SPC1050-0315-VA	10,5	12	102	55	31,5
SPC1060-0318-VA	10,6	12	102	55	31,8
SPC1070-0321-VA	10,7	12	102	55	32,1
SPC1080-0324-VA	10,8	12	102	55	32,4
SPC1090-0327-VA	10,9	12	102	55	32,7
SPC1100-0330-VA	11,0	12	102	55	33,0
SPC1110-0333-VA	11,1	12	102	55	33,3
SPC1120-0336-VA	11,2	12	102	55	33,6
SPC1130-0339-VA	11,3	12	102	55	33,9
SPC1140-0342-VA	11,4	12	102	55	34,2
SPC1150-0345-VA	11,5	12	102	55	34,5
SPC1160-0348-VA	11,6	12	102	55	34,8
SPC1170-0351-VA	11,7	12	102	55	35,1
SPC1180-0354-VA	11,8	12	102	55	35,4
SPC1190-0357-VA	11,9	12	102	55	35,7
SPC1200-0360-VA	12,0	12	102	55	36,0
SPC1250-0375-VA	12,5	14	107	60	37,5
SPC1300-0390-VA	13,0	14	107	60	39,0
SPC1350-0405-VA	13,5	14	107	60	40,5
SPC1400-0420-VA	14,0	14	107	60	42,0
SPC1450-0435-VA	14,5	16	115	65	43,5
SPC1500-0450-VA	15,0	16	115	65	45,0
SPC1550-0465-VA	15,5	16	115	65	46,5
SPC1600-0480-VA	16,0	16	115	65	48,0
SPC1650-0495-VA	16,5	18	123	73	49,5

Bezeichnung Designation Articolo	d ₁ m7	d ₂ h6	l ₁	l ₂	l ₃
SPC1700-0510-VA	17,0	18	123	73	51,0
SPC1750-0525-VA	17,5	18	123	73	52,5
SPC1800-0540-VA	18,0	18	123	73	54,0
SPC1850-0555-VA	18,5	20	131	79	55,5
SPC1900-0570-VA	19,0	20	131	79	57,0
SPC1950-0585-VA	19,5	20	131	79	58,5
SPC2000-0600-VA	20,0	20	131	79	60,0

PM-HSS Spiralbohrer

Powder metal drills

Punta elicoidale in PM-HSS

kurze Ausführung, ohne Innenkühlung

short design, without through tool coolant
versione corta, senza raffreddamento interno

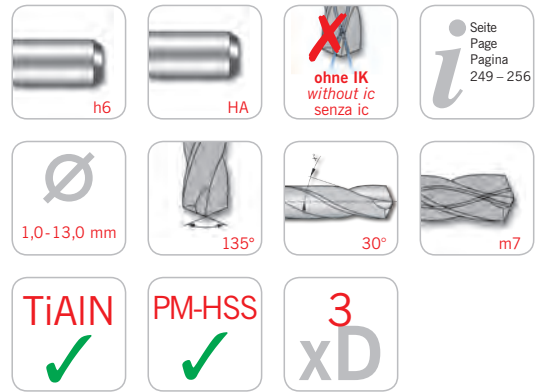

3 x D Ausführung Pulvermetallurgisches HSS

Execution powder metal drill

Versione punta elicoidale in PM-HSS

Bezeichnung Designation Articolo	d ₁ m7	d ₂ h6	l ₁	l ₂	l ₃
SP0010-0030-PM	1,0	3	38	6	3,0
SP0011-0033-PM	1,1	3	39	7	3,3
SP0012-0036-PM	1,2	3	40	8	3,6
SP0013-0039-PM	1,3	3	40	8	3,9
SP0014-0042-PM	1,4	3	41	9	4,2
SP0015-0045-PM	1,5	3	41	9	4,5
SP0016-0048-PM	1,6	3	42	10	4,8
SP0017-0051-PM	1,7	3	42	10	5,1
SP0018-0054-PM	1,8	3	43	11	5,4
SP0019-0057-PM	1,9	3	43	11	5,7
SP0020-0060-PM	2,0	3	44	12	6,0
SP0021-0063-PM	2,1	3	44	12	6,3
SP0022-0066-PM	2,2	3	45	13	6,6
SP0023-0069-PM	2,3	3	45	13	6,9
SP0024-0072-PM	2,4	3	46	14	7,2
SP0025-0075-PM	2,5	3	46	14	7,5
SP0026-0078-PM	2,6	3	46	14	7,8
SP0027-0081-PM	2,7	3	48	16	8,1
SP0028-0084-PM	2,8	3	48	16	8,4
SP0029-0087-PM	2,9	3	48	16	8,7
SP0030-0090-PM	3,0	3	48	16	9,0
SP0031-0093-PM	3,1	4	50	18	9,3
SP0032-0096-PM	3,2	4	50	18	9,6
SP0033-0099-PM	3,3	4	50	18	9,9
SP0034-0102-PM	3,4	4	52	20	10,2
SP0035-0105-PM	3,5	4	52	20	10,5
SP0036-0108-PM	3,6	4	52	20	10,8
SP0037-0111-PM	3,7	4	52	20	11,1
SP0038-0114-PM	3,8	4	54	22	11,4
SP0039-0117-PM	3,9	4	54	22	11,7
SP0040-0120-PM	4,0	4	54	22	12,0
SP0041-0123-PM	4,1	6	66	22	12,3
SP0042-0126-PM	4,2	6	66	22	12,6
SP0043-0129-PM	4,3	6	68	24	12,9
SP0044-0132-PM	4,4	6	68	24	13,2
SP0045-0135-PM	4,5	6	68	24	13,5
SP0046-0138-PM	4,6	6	68	24	13,8
SP0047-0141-PM	4,7	6	68	24	14,1
SP0048-0144-PM	4,8	6	70	26	14,4
SP0049-0147-PM	4,9	6	70	26	14,7
SP0050-0150-PM	5,0	6	70	26	15,0
SP0051-0153-PM	5,1	6	70	26	15,3

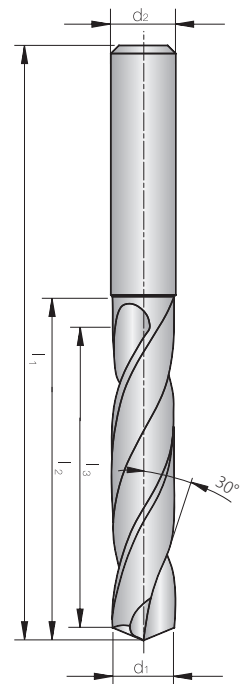

5

3 x D Ausführung Pulvermetallurgisches HSS

Execution powder metal drill

Versione punta elicoidale in PM-HSS

Bezeichnung Designation Articolo	d ₁ m7	d ₂ h6	l ₁	l ₂	l ₃
SP0052-0156-PM	5,2	6	70	26	15,6
SP0053-0159-PM	5,3	6	70	26	15,9
SP0054-0162-PM	5,4	6	72	28	16,2
SP0055-0165-PM	5,5	6	72	28	16,5
SP0055-01665-PM	5,55	6	72	28	16,65
SP0056-0168-PM	5,6	6	72	28	16,8
SP0057-0171-PM	5,7	6	72	28	17,1
SP0058-0174-PM	5,8	6	72	28	17,4
SP0059-0177-PM	5,9	6	72	28	17,7
SP0060-0180-PM	6,0	6	72	28	18,0
SP0061-0183-PM	6,1	8	75	31	18,3
SP0062-0186-PM	6,2	8	75	31	18,6
SP0063-0189-PM	6,3	8	75	31	18,9
SP0064-0192-PM	6,4	8	75	31	19,2
SP0065-0195-PM	6,5	8	75	31	19,5
SP0066-0198-PM	6,6	8	75	31	19,8
SP0067-0201-PM	6,7	8	75	31	20,1
SP0068-0204-PM	6,8	8	78	34	20,4
SP0069-0207-PM	6,9	8	78	34	20,7
SP0070-0210-PM	7,0	8	78	34	21,0
SP0071-0213-PM	7,1	8	78	34	21,3
SP0072-0216-PM	7,2	8	78	34	21,6
SP0073-0219-PM	7,3	8	78	34	21,9
SP0074-0222-PM	7,4	8	78	34	22,2
SP0075-0225-PM	7,5	8	78	34	22,5
SP0076-0228-PM	7,6	8	81	37	22,8
SP0077-0231-PM	7,7	8	81	37	23,1
SP0078-0234-PM	7,8	8	81	37	23,4
SP0079-0237-PM	7,9	8	81	37	23,7
SP0080-0240-PM	8,0	8	81	37	24,0
SP0081-0243-PM	8,1	10	87	37	24,3
SP0082-0246-PM	8,2	10	87	37	24,6
SP0083-0249-PM	8,3	10	87	37	24,9
SP0084-0252-PM	8,4	10	87	37	25,2
SP0085-0255-PM	8,5	10	87	37	25,5
SP0086-0258-PM	8,6	10	90	40	25,8
SP0087-0261-PM	8,7	10	90	40	26,1
SP0088-0264-PM	8,8	10	90	40	26,4
SP0089-0267-PM	8,9	10	90	40	26,7
SP0090-0270-PM	9,0	10	90	40	27,0
SP0091-0273-PM	9,1	10	90	40	27,3
SP0092-0276-PM	9,2	10	90	40	27,6
SP0093-0279-PM	9,3	10	90	40	27,9
SP0094-0282-PM	9,4	10	90	40	28,2
SP0095-0285-PM	9,5	10	90	40	28,5
SP0096-0288-PM	9,6	10	93	43	28,8
SP0097-0291-PM	9,7	10	93	43	29,1
SP0098-0294-PM	9,8	10	93	43	29,4
SP0099-0297-PM	9,9	10	93	43	29,7
SP0100-0300-PM	10,0	10	93	43	30,0
SP0101-0303-PM	10,1	12	100	43	30,3
SP0102-0306-PM	10,2	12	100	43	30,6
SP0103-0309-PM	10,3	12	100	43	30,9
SP0104-0312-PM	10,4	12	100	43	31,2
SP0105-0315-PM	10,5	12	100	43	31,5
SP0106-0318-PM	10,6	12	100	43	31,8
SP0107-0321-PM	10,7	12	104	47	32,1
SP0108-0324-PM	10,8	12	104	47	32,4

Bezeichnung Designation Articolo	d ₁ m7	d ₂ h6	l ₁	l ₂	l ₃
SP0109-0327-PM	10,9	12	104	47	32,7
SP0110-0330-PM	11,0	12	104	47	33,0
SP0111-0333-PM	11,1	12	104	47	33,3
SP0112-0336-PM	11,2	12	104	47	33,6
SP0113-0339-PM	11,3	12	104	47	33,9
SP0114-0342-PM	11,4	12	104	47	34,2
SP0115-0345-PM	11,5	12	104	47	34,5
SP0116-0348-PM	11,6	12	104	47	34,8
SP0117-0351-PM	11,7	12	104	47	35,1
SP0118-0354-PM	11,8	12	104	47	35,4
SP0119-0357-PM	11,9	12	108	51	35,7
SP0120-0360-PM	12,0	12	108	51	36,0
SP0121-0363-PM	12,1	12	108	51	36,3
SP0122-0366-PM	12,2	12	108	51	36,6
SP0123-0369-PM	12,3	12	108	51	36,9
SP0124-0372-PM	12,4	12	108	51	37,2
SP0125-0375-PM	12,5	12	108	51	37,5
SP0126-0378-PM	12,6	12	108	51	37,8
SP0127-0381-PM	12,7	12	108	51	38,1
SP0128-0384-PM	12,8	12	108	51	38,4
SP0129-0387-PM	12,9	12	108	51	38,7
SP0130-0390-PM	13,0	12	108	51	39,0
SP0133-0399-PM	13,3	12	108	51	39,9



Vollhartmetall-Spiralbohrer

Solid carbide drills

Punta elicoidale in metallo duro

mittellange Ausführung, ohne Innenkühlung

mid-length design, without through tool coolant

versione lunghezza media, senza raffreddamento interno



h6	HA	ohne IK without ic senza ic	Seite Page Pagina 249 - 256
1,0-20,0 mm	140°	30°	m7
TiAlN ✓	Feinstkorn-Micro-Grain Ultra micro granulation Ultra micro grana ✓	5 xD	

5 x D Ausführung

Execution / Versione

Bezeichnung Designation Articolo	d ₁ m7	d ₂ h6	l ₁	l ₂	l ₃
SP0010-0050	1,0	3	55	8	5,0
SP0011-0055	1,1	3	55	12	5,5
SP0012-0060	1,2	3	55	12	6,0
SP0013-0065	1,3	3	55	12	6,5
SP0014-0070	1,4	3	55	12	7,0
SP0015-0075	1,5	3	55	16	7,5
SP0016-0080	1,6	3	55	16	8,0
SP0017-0085	1,7	3	55	16	8,5
SP0018-0090	1,8	3	55	16	9,0
SP0019-0095	1,9	3	55	16	9,5
SP0020-0100	2,0	4	57	21	10,0
SP0021-0105	2,1	4	57	21	10,5
SP0022-0110	2,2	4	57	21	11,0
SP0023-0115	2,3	4	57	21	11,5
SP0024-0120	2,4	4	57	21	12,0
SP0025-0125	2,5	4	57	21	12,5
SP0026-0130	2,6	4	57	21	13,0
SP0027-0135	2,7	4	57	21	13,5
SP0028-0140	2,8	4	57	21	14,0
SP0029-0145	2,9	4	57	21	14,5
SP0030-0150	3,0	6	66	28	15,0
SP0031-0155	3,1	6	66	28	15,5
SP0032-0160	3,2	6	66	28	16,0
SP0033-0165	3,3	6	66	28	16,5
SP0034-0170	3,4	6	66	28	17,0
SP0035-0175	3,5	6	66	28	17,5
SP0036-0180	3,6	6	66	28	18,0
SP0037-0185	3,7	6	66	28	18,5
SP0038-0190	3,8	6	74	36	19,0
SP0039-0195	3,9	6	74	36	19,5
SP0040-0200	4,0	6	74	36	20,0
SP0041-0205	4,1	6	74	36	20,5
SP0042-0210	4,2	6	74	36	21,0
SP0043-0215	4,3	6	74	36	21,5
SP0044-0220	4,4	6	74	36	22,0
SP0045-0225	4,5	6	74	36	22,5
SP0046-0230	4,6	6	74	36	23,0
SP0047-0235	4,7	6	74	36	23,5
SP0048-0240	4,8	6	82	44	24,0
SP0049-0245	4,9	6	82	44	24,5
SP0050-0250	5,0	6	82	44	25,0
SP0051-0255	5,1	6	82	44	25,5
SP0052-0260	5,2	6	82	44	26,0
SP0053-0265	5,3	6	82	44	26,5

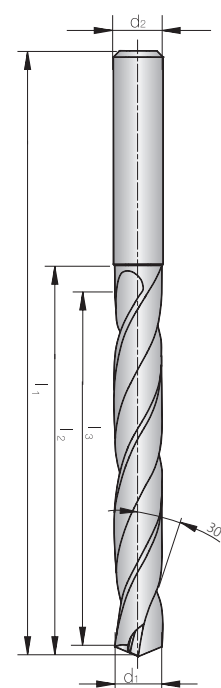

5

5 x D Ausführung Execution / Versione

Bezeichnung Designation Articolo	d ₁ m7	d ₂ h6	l ₁	l ₂	l ₃
SP0054-0270	5,4	6	82	44	27,0
SP0055-0275	5,5	6	82	44	27,5
SP0056-0280	5,6	6	82	44	28,0
SP0057-0285	5,7	6	82	44	28,5
SP0058-0290	5,8	6	82	44	29,0
SP0059-0295	5,9	6	82	44	29,5
SP0060-0300	6,0	6	82	44	30,0
SP0061-0305	6,1	8	91	53	30,5
SP0062-0310	6,2	8	91	53	31,0
SP0063-0315	6,3	8	91	53	31,5
SP0064-0320	6,4	8	91	53	32,0
SP0065-0325	6,5	8	91	53	32,5
SP0066-0330	6,6	8	91	53	33,0
SP0067-0335	6,7	8	91	53	33,5
SP0068-0340	6,8	8	91	53	34,0
SP0069-0345	6,9	8	91	53	34,5
SP0070-0350	7,0	8	91	53	35,0
SP0071-0355	7,1	8	91	53	35,5
SP0072-0360	7,2	8	91	53	36,0
SP0073-0365	7,3	8	91	53	36,5
SP0074-0370	7,4	8	91	53	37,0
SP0075-0375	7,5	8	91	53	37,5
SP0076-0380	7,6	8	91	53	38,0
SP0077-0385	7,7	8	91	53	38,5
SP0078-0390	7,8	8	91	53	39,0
SP0079-0395	7,9	8	91	53	39,5
SP0080-0400	8,0	8	91	53	40,0
SP0081-0405	8,1	10	103	61	40,5
SP0082-0410	8,2	10	103	61	41,0
SP0083-0415	8,3	10	103	61	41,5
SP0084-0420	8,4	10	103	61	42,0
SP0085-0425	8,5	10	103	61	42,5
SP0086-0430	8,6	10	103	61	43,0
SP0087-0435	8,7	10	103	61	43,5
SP0088-0440	8,8	10	103	61	44,0
SP0089-0445	8,9	10	103	61	44,5
SP0090-0450	9,0	10	103	61	45,0
SP0091-0455	9,1	10	103	61	45,5
SP0092-0460	9,2	10	103	61	46,0
SP0093-0465	9,3	10	103	61	46,5
SP0094-0470	9,4	10	103	61	47,0
SP0095-0475	9,5	10	103	61	47,5
SP0096-0480	9,6	10	103	61	48,0
SP0097-0485	9,7	10	103	61	48,5
SP0098-0490	9,8	10	103	61	49,0
SP0099-0495	9,9	10	103	61	49,5
SP0100-0500	10,0	10	103	61	50,0
SP0101-0505	10,1	12	118	71	50,5
SP0102-0510	10,2	12	118	71	51,0
SP0103-0515	10,3	12	118	71	51,5
SP0104-0520	10,4	12	118	71	52,0
SP0105-0525	10,5	12	118	71	52,5
SP0106-0530	10,6	12	118	71	53,0
SP0107-0535	10,7	12	118	71	53,5
SP0108-0540	10,8	12	118	71	54,0
SP0109-0545	10,9	12	118	71	54,5
SP0110-0550	11,0	12	118	71	55,0
SP0111-0555	11,1	12	118	71	55,5
SP0112-0560	11,2	12	118	71	56,0
SP0113-0565	11,3	12	118	71	56,5

Bezeichnung Designation Articolo	d ₁ m7	d ₂ h6	l ₁	l ₂	l ₃
SP0114-0570	11,4	12	118	71	57,0
SP0115-0575	11,5	12	118	71	57,5
SP0116-0580	11,6	12	118	71	58,0
SP0117-0585	11,7	12	118	71	58,5
SP0118-0590	11,8	12	118	71	59,0
SP0119-0595	11,9	12	118	71	59,5
SP0120-0600	12,0	12	118	71	60,0
SP0123-0615	12,3	14	124	77	61,5
SP0125-0625	12,5	14	124	77	62,5
SP0128-0640	12,8	14	124	77	64,0
SP0130-0650	13,0	14	124	77	65,0
SP0135-0675	13,5	14	124	77	67,5
SP0138-0690	13,8	14	124	77	69,0
SP0140-0700	14,0	14	124	77	70,0
SP0145-0725	14,5	16	133	83	72,5
SP0148-0740	14,8	16	133	83	74,0
SP0150-0750	15,0	16	133	83	75,0
SP0155-0775	15,5	16	133	83	77,5
SP0158-0790	15,8	16	133	83	79,0
SP0160-0800	16,0	16	133	83	80,0
SP0165-0825	16,5	18	143	93	82,5
SP0168-0840	16,8	18	143	93	84,0
SP0170-0850	17,0	18	143	93	85,0
SP0175-0875	17,5	18	143	93	87,5
SP0178-0890	17,8	18	143	93	89,0
SP0180-0900	18,0	18	143	93	90,0
SP0185-0925	18,5	20	153	101	92,5
SP0190-0950	19,0	20	153	101	95,0
SP0195-0975	19,5	20	153	101	97,5
SP0198-0990	19,8	20	153	101	99,0
SP0200-1000	20,0	20	153	101	100,0



Vollhartmetall-Spiralbohrer

Solid carbide drills

Punta elicoidale in metallo duro

mittellange Ausführung, mit Innenkühlung

mid-length design, with through tool coolant

versione lunghezza media, con raffreddamento interno

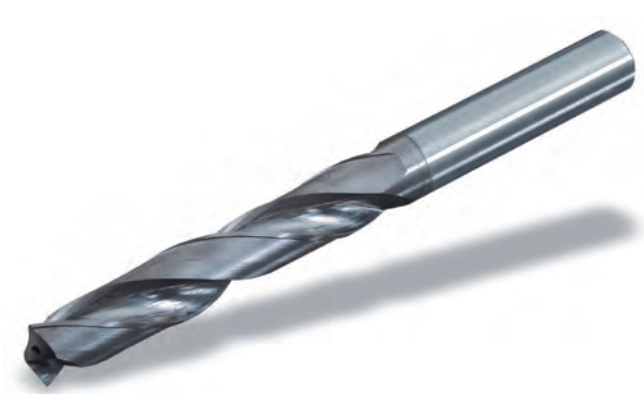





h6



HAK



mit IK
with ic
con ic



Seite
Page
Pagina
249 - 256



1,0-20,0 mm



140°

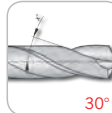

30°



m7



TiAlN



Feinstkorn-Micro-Grain
Ultra micro granulation
Ultra micro grana



5
xD

5 x D Ausführung

Execution / Versione

Bezeichnung Designation Articolo	d ₁ m7	d ₂ h6	l ₁	l ₂	l ₃
SPC0010-0050	1,0	3	55	8	5,0
SPC0011-0055	1,1	3	55	12	5,5
SPC0012-0060	1,2	3	55	12	6,0
SPC0013-0065	1,3	3	55	12	6,5
SPC0014-0070	1,4	3	55	12	7,0
SPC0015-0075	1,5	3	55	16	7,5
SPC0016-0080	1,6	3	55	16	8,0
SPC0017-0085	1,7	3	55	16	8,5
SPC0018-0090	1,8	3	55	16	9,0
SPC0019-0095	1,9	3	55	16	9,5
SPC0020-0100	2,0	4	57	21	10,0
SPC0021-0105	2,1	4	57	21	10,5
SPC0022-0110	2,2	4	57	21	11,0
SPC0023-0115	2,3	4	57	21	11,5
SPC0024-0120	2,4	4	57	21	12,0
SPC0025-0125	2,5	4	57	21	12,5
SPC0026-0130	2,6	4	57	21	13,0
SPC0027-0135	2,7	4	57	21	13,5
SPC0028-0140	2,8	4	57	21	14,0
SPC0029-0145	2,9	4	57	21	14,5
SPC0030-0150	3,0	6	66	28	15,0
SPC0031-0155	3,1	6	66	28	15,5
SPC0032-0160	3,2	6	66	28	16,0
SPC0033-0165	3,3	6	66	28	16,5
SPC0034-0170	3,4	6	66	28	17,0
SPC0035-0175	3,5	6	66	28	17,5
SPC0036-0180	3,6	6	66	28	18,0
SPC0037-0185	3,7	6	66	28	18,5
SPC0038-0190	3,8	6	74	36	19,0
SPC0039-0195	3,9	6	74	36	19,5
SPC0040-0200	4,0	6	74	36	20,0
SPC0041-0205	4,1	6	74	36	20,5
SPC0042-0210	4,2	6	74	36	21,0
SPC0043-0215	4,3	6	74	36	21,5
SPC0044-0220	4,4	6	74	36	22,0
SPC0045-0225	4,5	6	74	36	22,5
SPC0046-0230	4,6	6	74	36	23,0
SPC0047-0235	4,7	6	74	36	23,5
SPC0048-0240	4,8	6	82	44	24,0
SPC0049-0245	4,9	6	82	44	24,5
SPC0050-0250	5,0	6	82	44	25,0
SPC0051-0255	5,1	6	82	44	25,5
SPC0052-0260	5,2	6	82	44	26,0
SPC0053-0265	5,3	6	82	44	26,5

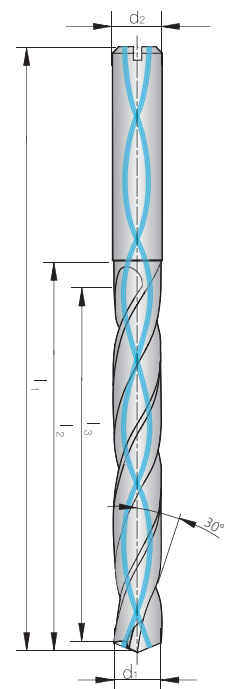

5

5 x D Ausführung Execution / Versione

Bezeichnung Designation Articolo	d ₁ m7	d ₂ h6	l ₁	l ₂	l ₃
SPC0054-0270	5,4	6	82	44	27,0
SPC0055-0275	5,5	6	82	44	27,5
SPC0056-0280	5,6	6	82	44	28,0
SPC0057-0285	5,7	6	82	44	28,5
SPC0058-0290	5,8	6	82	44	29,0
SPC0059-0295	5,9	6	82	44	29,5
SPC0060-0300	6,0	6	82	44	30,0
SPC0061-0305	6,1	8	91	53	30,5
SPC0062-0310	6,2	8	91	53	31,0
SPC0063-0315	6,3	8	91	53	31,5
SPC0064-0320	6,4	8	91	53	32,0
SPC0065-0325	6,5	8	91	53	32,5
SPC0066-0330	6,6	8	91	53	33,0
SPC0067-0335	6,7	8	91	53	33,5
SPC0068-0340	6,8	8	91	53	34,0
SPC0069-0345	6,9	8	91	53	34,5
SPC0070-0350	7,0	8	91	53	35,0
SPC0071-0355	7,1	8	91	53	35,5
SPC0072-0360	7,2	8	91	53	36,0
SPC0073-0365	7,3	8	91	53	36,5
SPC0074-0370	7,4	8	91	53	37,0
SPC0075-0375	7,5	8	91	53	37,5
SPC0076-0380	7,6	8	91	53	38,0
SPC0077-0385	7,7	8	91	53	38,5
SPC0078-0390	7,8	8	91	53	39,0
SPC0079-0395	7,9	8	91	53	39,5
SPC0080-0400	8,0	8	91	53	40,0
SPC0081-0405	8,1	10	103	61	40,5
SPC0082-0410	8,2	10	103	61	41,0
SPC0083-0415	8,3	10	103	61	41,5
SPC0084-0420	8,4	10	103	61	42,0
SPC0085-0425	8,5	10	103	61	42,5
SPC0086-0430	8,6	10	103	61	43,0
SPC0087-0435	8,7	10	103	61	43,5
SPC0088-0440	8,8	10	103	61	44,0
SPC0089-0445	8,9	10	103	61	44,5
SPC0090-0450	9,0	10	103	61	45,0
SPC0091-0455	9,1	10	103	61	45,5
SPC0092-0460	9,2	10	103	61	46,0
SPC0093-0465	9,3	10	103	61	46,5
SPC0094-0470	9,4	10	103	61	47,0
SPC0095-0475	9,5	10	103	61	47,5
SPC0096-0480	9,6	10	103	61	48,0
SPC0097-0485	9,7	10	103	61	48,5
SPC0098-0490	9,8	10	103	61	49,0
SPC0099-0495	9,9	10	103	61	49,5
SPC0100-0500	10,0	10	103	61	50,0
SPC0101-0505	10,1	12	118	71	50,5
SPC0102-0510	10,2	12	118	71	51,0
SPC0103-0515	10,3	12	118	71	51,5
SPC0104-0520	10,4	12	118	71	52,0
SPC0105-0525	10,5	12	118	71	52,5
SPC0106-0530	10,6	12	118	71	53,0
SPC0107-0535	10,7	12	118	71	53,5
SPC0108-0540	10,8	12	118	71	54,0
SPC0109-0545	10,9	12	118	71	54,5
SPC0110-0550	11,0	12	118	71	55,0
SPC0111-0555	11,1	12	118	71	55,5
SPC0112-0560	11,2	12	118	71	56,0
SPC0113-0565	11,3	12	118	71	56,5

Bezeichnung Designation Articolo	d ₁ m7	d ₂ h6	l ₁	l ₂	l ₃
SPC0114-0570	11,4	12	118	71	57,0
SPC0115-0575	11,5	12	118	71	57,5
SPC0116-0580	11,6	12	118	71	58,0
SPC0117-0585	11,7	12	118	71	58,5
SPC0118-0590	11,8	12	118	71	59,0
SPC0119-0595	11,9	12	118	71	59,5
SPC0120-0600	12,0	12	118	71	60,0
SPC0125-0625	12,5	14	124	77	62,5
SPC0127-0635	12,7	14	124	77	63,5
SPC0128-0640	12,8	14	124	77	64,0
SPC0130-0650	13,0	14	124	77	65,0
SPC0132-0660	13,2	14	124	77	66,0
SPC0135-0675	13,5	14	124	77	67,5
SPC0140-0700	14,0	14	124	77	70,0
SPC0142-0710	14,2	16	133	83	71,0
SPC0145-0725	14,5	16	133	83	72,5
SPC0150-0750	15,0	16	133	83	75,0
SPC0155-0775	15,5	16	133	83	77,5
SPC0160-0800	16,0	16	133	83	80,0
SPC0165-0825	16,5	18	143	93	82,5
SPC0170-0850	17,0	18	143	93	85,0
SPC0175-0875	17,5	18	143	93	87,5
SPC0180-0900	18,0	18	143	93	90,0
SPC0185-0925	18,5	20	153	101	92,5
SPC0188-0940	18,8	20	153	101	94,0
SPC0190-0950	19,0	20	153	101	95,0
SPC0195-0975	19,5	20	153	101	97,5
SPC0200-1000	20,0	20	153	101	100,0



Vollhartmetall-Spiralbohrer mittellange Ausführung, mit Innenkühlung, Diamant beschichtet

Solid carbide drills

mid-length design, with through tool coolant, diamond coated

Punta elicoidale in metallo duro

lunghezza media, con raffreddamento interno, rivestita Diamante DLC

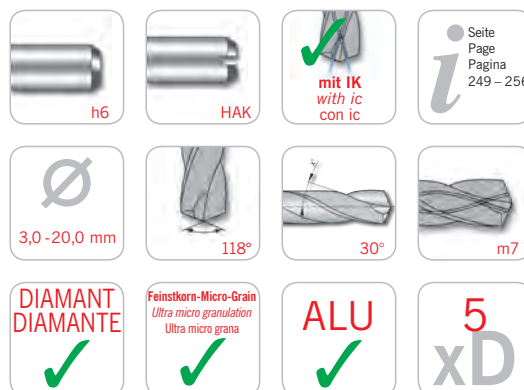

5 x D Ausführung für Aluminium

Execution for aluminium

Versione per Alluminio e leghe non ferrose

Bezeichnung Designation Articolo	d ₁ m7	d ₂ h6	l ₁	l ₂	l ₃
SPC0030-0150-ALU	3,0	6	66	28	15,0
SPC0031-0155-ALU	3,1	6	66	28	15,5
SPC0032-0160-ALU	3,2	6	66	28	16,0
SPC0033-0165-ALU	3,3	6	66	28	16,5
SPC0034-0170-ALU	3,4	6	66	28	17,0
SPC0035-0175-ALU	3,5	6	66	28	17,5
SPC0036-0180-ALU	3,6	6	66	28	18,0
SPC0037-0185-ALU	3,7	6	66	28	18,5
SPC0038-0190-ALU	3,8	6	74	36	19,0
SPC0039-0195-ALU	3,9	6	74	36	19,5
SPC0040-0200-ALU	4,0	6	74	36	20,0
SPC0041-0205-ALU	4,1	6	74	36	20,5
SPC0042-0210-ALU	4,2	6	74	36	21,0
SPC0043-0215-ALU	4,3	6	74	36	21,5
SPC0044-0220-ALU	4,4	6	74	36	22,0
SPC0045-0225-ALU	4,5	6	74	36	22,5
SPC0046-0230-ALU	4,6	6	74	36	23,0
SPC0047-0235-ALU	4,7	6	74	36	23,5
SPC0048-0240-ALU	4,8	6	82	44	24,0
SPC0049-0245-ALU	4,9	6	82	44	24,5
SPC0050-0250-ALU	5,0	6	82	44	25,0
SPC0051-0255-ALU	5,1	6	82	44	25,5
SPC0052-0260-ALU	5,2	6	82	44	26,0
SPC0053-0265-ALU	5,3	6	82	44	26,5
SPC0054-0270-ALU	5,4	6	82	44	27,0
SPC0055-0275-ALU	5,5	6	82	44	27,5
SPC0056-0280-ALU	5,6	6	82	44	28,0
SPC0057-0285-ALU	5,7	6	82	44	28,5
SPC0058-0290-ALU	5,8	6	82	44	29,0
SPC0059-0295-ALU	5,9	6	82	44	29,5
SPC0060-0300-ALU	6,0	6	82	44	30,0
SPC0061-0305-ALU	6,1	8	91	53	30,5
SPC0062-0310-ALU	6,2	8	91	53	31,0
SPC0063-0315-ALU	6,3	8	91	53	31,5
SPC0064-0320-ALU	6,4	8	91	53	32,0
SPC0065-0325-ALU	6,5	8	91	53	32,5
SPC0066-0330-ALU	6,6	8	91	53	33,0
SPC0067-0335-ALU	6,7	8	91	53	33,5
SPC0068-0340-ALU	6,8	8	91	53	34,0
SPC0069-0345-ALU	6,9	8	91	53	34,5
SPC0070-0350-ALU	7,0	8	91	53	35,0
SPC0071-0355-ALU	7,1	8	91	53	35,5

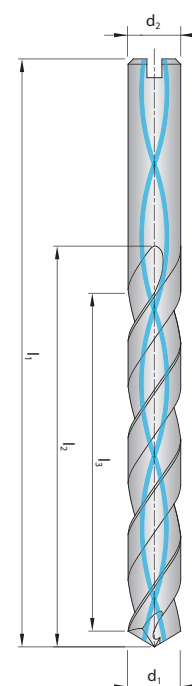

5

5 x D Ausführung für Aluminium

Execution for aluminium

Versione per Alluminio e leghe non ferrose

Bezeichnung Designation Articolo	d ₁ m7	d ₂ h6	l ₁	l ₂	l ₃
SPC0072-0360-ALU	7,2	8	91	53	36,0
SPC0073-0365-ALU	7,3	8	91	53	36,5
SPC0074-0370-ALU	7,4	8	91	53	37,0
SPC0075-0375-ALU	7,5	8	91	53	37,5
SPC0076-0380-ALU	7,6	8	91	53	38,0
SPC0077-0385-ALU	7,7	8	91	53	38,5
SPC0078-0390-ALU	7,8	8	91	53	39,0
SPC0079-0395-ALU	7,9	8	91	53	39,5
SPC0080-0400-ALU	8,0	8	91	53	40,0
SPC0081-0405-ALU	8,1	10	103	61	40,5
SPC0082-0410-ALU	8,2	10	103	61	41,0
SPC0083-0415-ALU	8,3	10	103	61	41,5
SPC0084-0420-ALU	8,4	10	103	61	42,0
SPC0085-0425-ALU	8,5	10	103	61	42,5
SPC0086-0430-ALU	8,6	10	103	61	43,0
SPC0087-0435-ALU	8,7	10	103	61	43,5
SPC0088-0440-ALU	8,8	10	103	61	44,0
SPC0089-0445-ALU	8,9	10	103	61	44,5
SPC0090-0450-ALU	9,0	10	103	61	45,0
SPC0091-0455-ALU	9,1	10	103	61	45,5
SPC0092-0460-ALU	9,2	10	103	61	46,0
SPC0093-0465-ALU	9,3	10	103	61	46,5
SPC0094-0470-ALU	9,4	10	103	61	47,0
SPC0095-0475-ALU	9,5	10	103	61	47,5
SPC0096-0480-ALU	9,6	10	103	61	48,0
SPC0097-0485-ALU	9,7	10	103	61	48,5
SPC0098-0490-ALU	9,8	10	103	61	49,0
SPC0099-0495-ALU	9,9	10	103	61	49,5
SPC0100-0500-ALU	10,0	10	103	61	50,0
SPC0101-0505-ALU	10,1	12	118	71	50,5
SPC0102-0510-ALU	10,2	12	118	71	51,0
SPC0103-0515-ALU	10,3	12	118	71	51,5
SPC0104-0520-ALU	10,4	12	118	71	52,0
SPC0105-0525-ALU	10,5	12	118	71	52,5
SPC0106-0530-ALU	10,6	12	118	71	53,0
SPC0107-0535-ALU	10,7	12	118	71	53,5
SPC0108-0540-ALU	10,8	12	118	71	54,0
SPC0109-0545-ALU	10,9	12	118	71	54,5
SPC0110-0550-ALU	11,0	12	118	71	55,0
SPC0111-0555-ALU	11,1	12	118	71	55,5
SPC0112-0560-ALU	11,2	12	118	71	56,0
SPC0113-0565-ALU	11,3	12	118	71	56,5
SPC0114-0570-ALU	11,4	12	118	71	57,0
SPC0115-0575-ALU	11,5	12	118	71	57,5
SPC0116-0580-ALU	11,6	12	118	71	58,0
SPC0117-0585-ALU	11,7	12	118	71	58,5
SPC0118-0590-ALU	11,8	12	118	71	59,0
SPC0119-0595-ALU	11,9	12	118	71	59,5
SPC0120-0600-ALU	12,0	12	118	71	60,0
SPC0123-0615-ALU	12,3	14	124	77	61,5
SPC0125-0625-ALU	12,5	14	124	77	62,5
SPC0128-0640-ALU	12,8	14	124	77	64,0
SPC0130-0650-ALU	13,0	14	124	77	65,0
SPC0135-0675-ALU	13,5	14	124	77	67,5
SPC0138-0690-ALU	13,8	14	124	77	69,0
SPC0140-0700-ALU	14,0	14	124	77	70,0
SPC0145-0725-ALU	14,5	16	133	83	72,5
SPC0148-0740-ALU	14,8	16	133	83	74,0

Bezeichnung Designation Articolo	d ₁ m7	d ₂ h6	l ₁	l ₂	l ₃
SPC0150-0750-ALU	15,0	16	133	83	75,0
SPC0155-0775-ALU	15,5	16	133	83	77,5
SPC0158-0790-ALU	15,8	16	133	83	79,0
SPC0160-0800-ALU	16,0	16	133	83	80,0
SPC0165-0825-ALU	16,5	18	143	93	82,5
SPC0168-0840-ALU	16,8	18	143	93	84,0
SPC0170-0850-ALU	17,0	18	143	93	85,0
SPC0175-0875-ALU	17,5	18	143	93	87,5
SPC0178-0890-ALU	17,8	18	143	93	89,0
SPC0180-0900-ALU	18,0	18	143	93	90,0
SPC0185-0925-ALU	18,5	20	153	101	92,5
SPC0190-0950-ALU	19,0	20	153	101	95,0
SPC0195-0975-ALU	19,5	20	153	101	97,5
SPC0198-0990-ALU	19,8	20	153	101	99,0
SPC0200-1000-ALU	20,0	20	153	101	100,0



Vollhartmetall-Spiralbohrer

Solid carbide drills

Punta elicoidale in metallo duro

mittellange Ausführung, mit Innenkühlung

mid-length design, with through tool coolant

versione lunghezza media, con raffreddamento interno

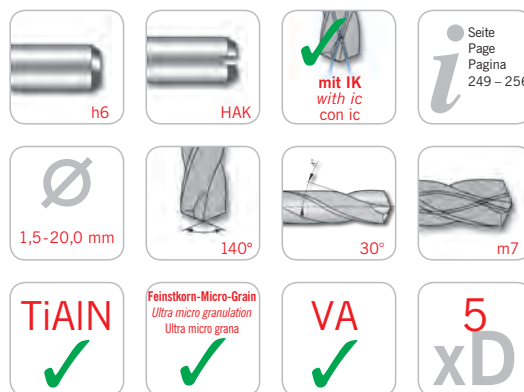

5 x D Ausführung für rostfreie Stähle

Execution for stainless steel

Versione per Acciai Inossidabili

Bezeichnung Designation Articolo	d ₁ m7	d ₂ h6	l ₁	l ₂	l ₃
SPC0015-0075-VA	1,5	3	55	16	7,5
SPC0016-0080-VA	1,6	3	55	16	8,0
SPC0017-0085-VA	1,7	3	55	16	8,5
SPC0018-0090-VA	1,8	3	55	16	9,0
SPC0019-0095-VA	1,9	3	55	16	9,5
SPC0020-0100-VA	2,0	4	57	21	10,0
SPC0021-0105-VA	2,1	4	57	21	10,5
SPC0022-0110-VA	2,2	4	57	21	11,0
SPC0023-0115-VA	2,3	4	57	21	11,5
SPC0024-0120-VA	2,4	4	57	21	12,0
SPC0025-0125-VA	2,5	4	57	21	12,5
SPC0026-0130-VA	2,6	4	57	21	13,0
SPC0027-0135-VA	2,7	4	57	21	13,5
SPC0028-0140-VA	2,8	4	57	21	14,0
SPC0029-0145-VA	2,9	4	57	21	14,5
SPC0030-0150-VA	3,0	6	66	28	15,0
SPC0031-0155-VA	3,1	6	66	28	15,5
SPC0032-0160-VA	3,2	6	66	28	16,0
SPC0033-0165-VA	3,3	6	66	28	16,5
SPC0034-0170-VA	3,4	6	66	28	17,0
SPC0035-0175-VA	3,5	6	66	28	17,5
SPC0036-0180-VA	3,6	6	66	28	18,0
SPC0037-0185-VA	3,7	6	66	28	18,5
SPC0038-0190-VA	3,8	6	74	36	19,0
SPC0039-0195-VA	3,9	6	74	36	19,5
SPC0040-0200-VA	4,0	6	74	36	20,0
SPC0041-0205-VA	4,1	6	74	36	20,5
SPC0042-0210-VA	4,2	6	74	36	21,0
SPC0043-0215-VA	4,3	6	74	36	21,5
SPC0044-0220-VA	4,4	6	74	36	22,0
SPC0045-0225-VA	4,5	6	74	36	22,5
SPC0046-0230-VA	4,6	6	74	36	23,0
SPC0047-0235-VA	4,7	6	74	36	23,5
SPC0048-0240-VA	4,8	6	82	44	24,0
SPC0049-0245-VA	4,9	6	82	44	24,5
SPC0050-0250-VA	5,0	6	82	44	25,0
SPC0051-0255-VA	5,1	6	82	44	25,5
SPC0052-0260-VA	5,2	6	82	44	26,0
SPC0053-0265-VA	5,3	6	82	44	26,5
SPC0054-0270-VA	5,4	6	82	44	27,0
SPC0055-0275-VA	5,5	6	82	44	27,5
SPC0056-0280-VA	5,6	6	82	44	28,0

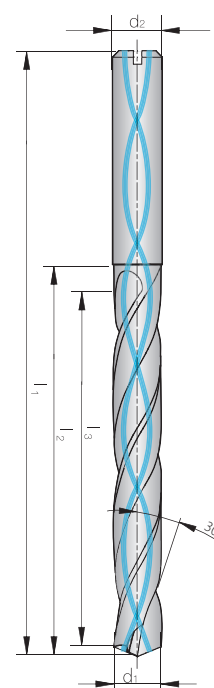

5

5 x D Ausführung für rostfreie Stähle

Execution for stainless steel

Versione per Acciai Inossidabili

Bezeichnung Designation Articolo	d ₁ m7	d ₂ h6	l ₁	l ₂	l ₃
SPC0057-0285-VA	5,7	6	82	44	28,5
SPC0058-0290-VA	5,8	6	82	44	29,0
SPC0059-0295-VA	5,9	6	82	44	29,5
SPC0060-0300-VA	6,0	6	82	44	30,0
SPC0061-0305-VA	6,1	8	91	53	30,5
SPC0062-0310-VA	6,2	8	91	53	31,0
SPC0063-0315-VA	6,3	8	91	53	31,5
SPC0064-0320-VA	6,4	8	91	53	32,0
SPC0065-0325-VA	6,5	8	91	53	32,5
SPC0066-0330-VA	6,6	8	91	53	33,0
SPC0067-0335-VA	6,7	8	91	53	33,5
SPC0068-0340-VA	6,8	8	91	53	34,0
SPC0069-0345-VA	6,9	8	91	53	34,5
SPC0070-0350-VA	7,0	8	91	53	35,0
SPC0071-0355-VA	7,1	8	91	53	35,5
SPC0072-0360-VA	7,2	8	91	53	36,0
SPC0073-0365-VA	7,3	8	91	53	36,5
SPC0074-0370-VA	7,4	8	91	53	37,0
SPC0075-0375-VA	7,5	8	91	53	37,5
SPC0076-0380-VA	7,6	8	91	53	38,0
SPC0077-0385-VA	7,7	8	91	53	38,5
SPC0078-0390-VA	7,8	8	91	53	39,0
SPC0079-0395-VA	7,9	8	91	53	39,5
SPC0080-0400-VA	8,0	8	91	53	40,0
SPC0081-0405-VA	8,1	10	103	61	40,5
SPC0082-0410-VA	8,2	10	103	61	41,0
SPC0083-0415-VA	8,3	10	103	61	41,5
SPC0084-0420-VA	8,4	10	103	61	42,0
SPC0085-0425-VA	8,5	10	103	61	42,5
SPC0086-0430-VA	8,6	10	103	61	43,0
SPC0087-0435-VA	8,7	10	103	61	43,5
SPC0088-0440-VA	8,8	10	103	61	44,0
SPC0089-0445-VA	8,9	10	103	61	44,5
SPC0090-0450-VA	9,0	10	103	61	45,0
SPC0091-0455-VA	9,1	10	103	61	45,5
SPC0092-0460-VA	9,2	10	103	61	46,0
SPC0093-0465-VA	9,3	10	103	61	46,5
SPC0094-0470-VA	9,4	10	103	61	47,0
SPC0095-0475-VA	9,5	10	103	61	47,5
SPC0096-0480-VA	9,6	10	103	61	48,0
SPC0097-0485-VA	9,7	10	103	61	48,5
SPC0098-0490-VA	9,8	10	103	61	49,0
SPC0099-0495-VA	9,9	10	103	61	49,5
SPC0100-0500-VA	10,0	10	103	61	50,0
SPC0101-0505-VA	10,1	12	118	71	50,5
SPC0102-0510-VA	10,2	12	118	71	51,0
SPC0103-0515-VA	10,3	12	118	71	51,5
SPC0104-0520-VA	10,4	12	118	71	52,0
SPC0105-0525-VA	10,5	12	118	71	52,5
SPC0106-0530-VA	10,6	12	118	71	53,0
SPC0107-0535-VA	10,7	12	118	71	53,5
SPC0108-0540-VA	10,8	12	118	71	54,0
SPC0109-0545-VA	10,9	12	118	71	54,5
SPC0110-0550-VA	11,0	12	118	71	55,0
SPC0111-0555-VA	11,1	12	118	71	55,5
SPC0112-0560-VA	11,2	12	118	71	56,0
SPC0113-0565-VA	11,3	12	118	71	56,5
SPC0114-0570-VA	11,4	12	118	71	57,0

Bezeichnung Designation Articolo	d ₁ m7	d ₂ h6	l ₁	l ₂	l ₃
SPC0115-0575-VA	11,5	12	118	71	57,5
SPC0116-0580-VA	11,6	12	118	71	58,0
SPC0117-0585-VA	11,7	12	118	71	58,5
SPC0118-0590-VA	11,8	12	118	71	59,0
SPC0119-0595-VA	11,9	12	118	71	59,5
SPC0120-0600-VA	12,0	12	118	71	60,0
SPC0125-0625-VA	12,5	14	124	77	62,5
SPC0130-0650-VA	13,0	14	124	77	65,0
SPC0135-0675-VA	13,5	14	124	77	67,5
SPC0140-0700-VA	14,0	14	124	77	70,0
SPC0145-0725-VA	14,5	16	133	83	72,5
SPC0150-0750-VA	15,0	16	133	83	75,0
SPC0155-0775-VA	15,5	16	133	83	77,5
SPC0160-0800-VA	16,0	16	133	83	80,0
SPC0165-0825-VA	16,5	18	143	93	82,5
SPC0170-0850-VA	17,0	18	143	93	85,0
SPC0175-0875-VA	17,5	18	143	93	87,5
SPC0180-0900-VA	18,0	18	143	93	90,0
SPC0185-0925-VA	18,5	20	153	101	92,5
SPC0190-0950-VA	19,0	20	153	101	95,0
SPC0195-0975-VA	19,5	20	153	101	97,5
SPC0200-1000-VA	20,0	20	153	101	100,0



Vollhartmetall-Spiralbohrer

Solid carbide drills

Punta elicoidale in metallo duro

mittellange Ausführung, ohne Innenkühlung

mid-length design, without through tool coolant

versione lunghezza media, senza raffreddamento interno



h6	HA	ohne IK without ic senza ic	Seite Page Pagina 249 - 256
3,0 - 14,0 mm	140°	15°	m7
TiAlN ✓	Feinstkorn-Micro-Grain Ultra micro granulation Ultra micro grana ✓	H ✓	

mittellange Ausführung für gehärtete Stähle

mid-length Execution for hardened steel

Versione lunghezza media per Acciai Temprati

Bezeichnung Designation Articolo	d ₁ m7	d ₂ h6	l ₁	l ₂
SP0030-0150-H	3,0	3	46	16
SP0032-0160-H	3,2	4	48	18
SP0033-0165-H	3,3	4	48	18
SP0034-0170-H	3,4	4	50	20
SP0035-0175-H	3,5	4	50	20
SP0040-0200-H	4,0	4	52	22
SP0042-0210-H	4,2	6	65	25
SP0043-0215-H	4,3	6	68	28
SP0044-0220-H	4,4	6	68	28
SP0045-0225-H	4,5	6	68	28
SP0050-0250-H	5,0	6	72	32
SP0051-0255-H	5,1	6	72	32
SP0052-0260-H	5,2	6	72	32
SP0055-0275-H	5,5	6	75	35
SP0060-0300-H	6,0	6	75	35
SP0065-0325-H	6,5	8	80	40
SP0068-0340-H	6,8	8	85	45
SP0069-0345-H	6,9	8	85	45
SP0070-0350-H	7,0	8	85	45
SP0075-0375-H	7,5	8	85	45
SP0080-0400-H	8,0	8	98	50
SP0085-0425-H	8,5	10	98	50
SP0086-0430-H	8,6	10	105	57
SP0088-0440-H	8,8	10	105	57
SP0090-0450-H	9,0	10	105	57
SP0095-0475-H	9,5	10	105	57
SP0100-0500-H	10,0	10	111	63
SP0102-0510-H	10,2	12	111	63
SP0103-0515-H	10,3	12	111	63
SP0105-0525-H	10,5	12	111	63
SP0108-0540-H	10,8	12	119	71
SP0110-0550-H	11,0	12	119	71
SP0115-0575-H	11,5	12	119	71
SP0120-0600-H	12,0	12	119	71
SP0140-0700-H	14,0	14	125	71

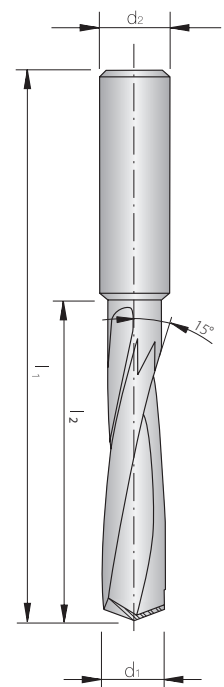

5

Schnell, flexibel und individuell.

Quick, flexible and individual.

Veloce, flessibile e individuale.

- **Wir bieten Ihnen Sonderlösungen für Ihre individuellen Bedürfnisse.**
 - **Bestellen Sie bis 18 Uhr unsere Produkte, erhalten Sie Ihre Lieferung bereits am nächsten Tag.**
 - **Da wir Konstruktion, Produktion und Vertrieb unter einem Dach vereinen, können wir eine hohe Qualität unserer Produkte garantieren.**
 - **Die Mitarbeiter unseres Außendienstes besuchen Sie regelmäßig und unterstützen Sie mit ihrem Produktwissen.**
 - **Unsere Anwendungstechniker beraten Sie direkt vor Ort in Ihrem Werk.**
 - **Die kompetenten ARNO-Ansprechpartner stehen Ihnen bei Fragen und Anliegen gerne zur Verfügung – weltweit.**
- *We offer special solutions for your individual requirement.*
 - *Order your products by 15.30 CET for same day dispatch.*
 - *As we design, manufacture, and service our own products, we offer you only top quality products.*
 - *Our external sales engineers will be visiting regularly.*
 - *Our trained engineers are experienced and will be able to help you with most applications.*
 - *Our competent global ARNO-partners are always available to answer any questions you may have.*
- Offriamo soluzioni speciali per le vostre esigenze.
 - Ordinate i nostri prodotti entro le 15,30 e li avrete il giorno dopo.
 - Possiamo offrirvi la massima qualità avendo produzione, progettazione e vendita in un unico posto.
 - Verete visitati regolarmente dai nostri collaboratori.
 - I nostri tecnici sapranno consigliarvi per il meglio.
 - Tutto il team ARNO è a vostra completa disposizione.



Weitere Informationen finden Sie unter

For more information see

Altre informazioni sotto

www.arno.de

Vollhartmetall-Spiralbohrer

Solid carbide drills

Punta elicoidale in metallo duro

lange Ausführung, ohne Innenkühlung

long design, without through tool coolant

versione lunga, senza raffreddamento interno

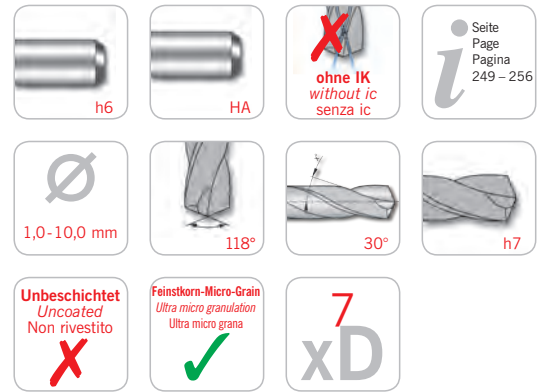

7 x D Ausführung Execution / Versione

Bezeichnung Designation Articolo	d ₁ m7	d ₂ h6	l ₁	l ₂	l ₃
SP0010-0070	1,0	1,0	34	12	7,0
SP0011-0077	1,1	1,1	36	14	7,7
SP0012-0084	1,2	1,2	38	16	8,4
SP0013-0091	1,3	1,3	38	16	9,1
SP0014-0098	1,4	1,4	40	18	9,8
SP0015-0105	1,5	1,5	40	18	10,5
SP0016-0112	1,6	1,6	43	20	11,2
SP0017-0119	1,7	1,7	43	20	11,9
SP0018-0126	1,8	1,8	46	22	12,6
SP0019-0133	1,9	1,9	46	22	13,3
SP0020-0140	2,0	2,0	49	24	14,0
SP0021-0147	2,1	2,1	49	24	14,7
SP0022-0154	2,2	2,2	53	27	15,4
SP0023-0161	2,3	2,3	53	27	16,1
SP0024-0168	2,4	2,4	57	30	16,8
SP0025-0175	2,5	2,5	57	30	17,5
SP0026-0182	2,6	2,6	57	30	18,2
SP0027-0189	2,7	2,7	61	33	18,9
SP0028-0196	2,8	2,8	61	33	19,6
SP0029-0203	2,9	2,9	61	33	20,3
SP0030-0210	3,0	3,0	61	33	21,0
SP0031-0217	3,1	3,1	65	36	21,7
SP0032-0224	3,2	3,2	65	36	22,4
SP0033-0231	3,3	3,3	65	36	23,1
SP0034-0238	3,4	3,4	70	39	23,8
SP0035-0245	3,5	3,5	70	39	24,5
SP0036-0252	3,6	3,6	70	39	25,2
SP0037-0259	3,7	3,7	70	39	25,9
SP0038-0266	3,8	3,8	75	43	26,6
SP0039-0273	3,9	3,9	75	43	27,3
SP0040-0280	4,0	4,0	75	43	28,0
SP0041-0287	4,1	4,1	75	43	28,7
SP0042-0294	4,2	4,2	75	43	29,4
SP0043-0301	4,3	4,3	80	47	30,1
SP0044-0308	4,4	4,4	80	47	30,8
SP0045-0315	4,5	4,5	80	47	31,5
SP0046-0322	4,6	4,6	80	47	32,2
SP0047-0329	4,7	4,7	80	47	32,9
SP0048-0336	4,8	4,8	86	52	33,6
SP0049-0343	4,9	4,9	86	52	34,3
SP0050-0350	5,0	5,0	86	52	35,0
SP0051-0357	5,1	5,1	86	52	35,7
SP0052-0364	5,2	5,2	86	52	36,4
SP0053-0371	5,3	5,3	86	52	37,1

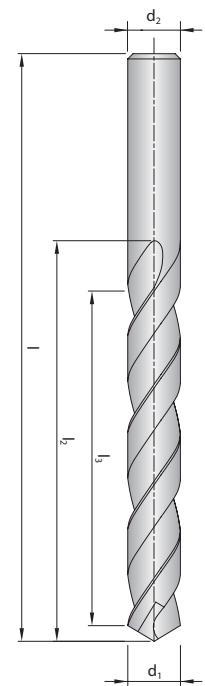

5

7 x D Ausführung Execution / Versione

Bezeichnung Designation Articolo	d ₁ m7	d ₂ h6	l ₁	l ₂	l ₃
SP0054-0378	5,4	5,4	93	57	37,8
SP0055-0385	5,5	5,5	93	57	38,5
SP0056-0392	5,6	5,6	93	57	39,2
SP0057-0399	5,7	5,7	93	57	39,9
SP0058-0406	5,8	5,8	93	57	40,6
SP0059-0413	5,9	5,9	93	57	41,3
SP0060-0420	6,0	6,0	93	57	42,0
SP0061-0427	6,1	6,1	101	63	42,7
SP0062-0434	6,2	6,2	101	63	43,4
SP0063-0441	6,3	6,3	101	63	44,1
SP0064-0448	6,4	6,4	101	63	44,8
SP0065-0455	6,5	6,5	101	63	45,5
SP0068-0476	6,8	6,8	109	69	47,6
SP0070-0490	7,0	7,0	109	69	49,0
SP0080-0560	8,0	8,0	117	75	56,0
SP0085-0595	8,5	8,5	117	75	59,5
SP0100-0700	10,0	10,0	133	87	70,0

PM-HSS Spiralbohrer

Powder metal drills

Punta elicoidale in PM-HSS

lange Ausführung, ohne Innenkühlung

long design, without through tool coolant

versione lunga, senza raffreddamento interno

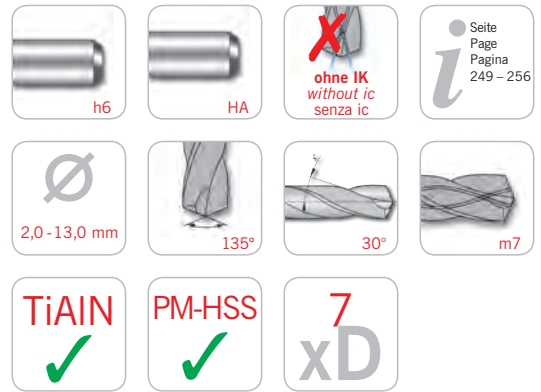

7 x D Ausführung Pulvermetallurgisches HSS

Execution powder metal drill

Versione punta elicoidale in PM-HSS

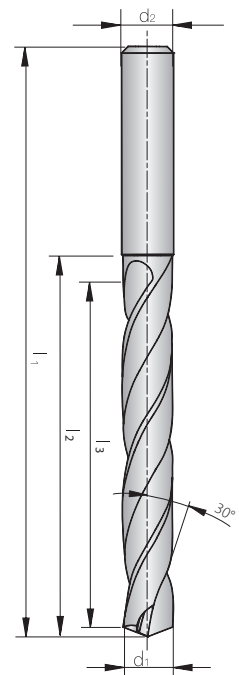

Bezeichnung Designation Articolo	d ₁ m7	d ₂ h6	l ₁	l ₂	l ₃
SP0020-0140-PM	2,0	3	56	24	14,0
SP0021-0147-PM	2,1	3	56	24	14,7
SP0022-0154-PM	2,2	3	56	25	15,4
SP0023-0161-PM	2,3	3	56	25	16,1
SP0024-0168-PM	2,4	3	61	30	16,8
SP0025-0175-PM	2,5	3	61	30	17,5
SP0026-0182-PM	2,6	3	61	30	18,2
SP0027-0189-PM	2,7	3	64	33	18,9
SP0028-0196-PM	2,8	3	64	33	19,6
SP0029-0203-PM	2,9	3	64	33	20,3
SP0030-0210-PM	3,0	3	64	33	21,0
SP0031-0217-PM	3,1	4	68	36	21,7
SP0032-0224-PM	3,2	4	68	36	22,4
SP0033-0231-PM	3,3	4	68	36	23,1
SP0034-0238-PM	3,4	4	71	39	23,8
SP0035-0245-PM	3,5	4	71	39	24,5
SP0036-0252-PM	3,6	4	71	39	25,2
SP0037-0259-PM	3,7	4	71	39	25,9
SP0038-0266-PM	3,8	4	75	43	26,6
SP0039-0273-PM	3,9	4	75	43	27,3
SP0040-0280-PM	4,0	4	75	43	28,0
SP0041-0287-PM	4,1	6	85	43	28,7
SP0042-0294-PM	4,2	6	85	43	29,4
SP0043-0301-PM	4,3	6	89	47	30,1
SP0044-0308-PM	4,4	6	89	47	30,8
SP0045-0315-PM	4,5	6	89	47	31,5
SP0046-0322-PM	4,6	6	89	47	32,2
SP0047-0329-PM	4,7	6	89	47	32,9
SP0048-0336-PM	4,8	6	94	52	33,6
SP0049-0343-PM	4,9	6	94	52	34,3
SP0050-0350-PM	5,0	6	94	52	35,0
SP0051-0357-PM	5,1	6	94	52	35,7
SP0052-0364-PM	5,2	6	94	52	36,4
SP0053-0371-PM	5,3	6	94	52	37,1
SP0054-0378-PM	5,4	6	99	57	37,8
SP0055-0385-PM	5,5	6	99	57	38,5
SP0056-0392-PM	5,6	6	99	57	39,2
SP0057-0399-PM	5,7	6	99	57	39,9
SP0058-0406-PM	5,8	6	99	57	40,6
SP0059-0413-PM	5,9	6	99	57	41,3
SP0060-0420-PM	6,0	6	99	57	42,0
SP0061-0427-PM	6,1	8	107	63	42,7

5

7 x D Ausführung Pulvermetallurgisches HSS

Execution powder metal drill

Versione punta elicoidale in PM-HSS

Bezeichnung Designation Articolo	d ₁ m7	d ₂ h6	l ₁	l ₂	l ₃
SP0062-0434-PM	6,2	8	107	63	43,4
SP0063-0441-PM	6,3	8	107	63	44,1
SP0064-0448-PM	6,4	8	107	63	44,8
SP0065-0455-PM	6,5	8	107	63	45,5
SP0066-0462-PM	6,6	8	107	63	46,2
SP0067-0469-PM	6,7	8	107	63	46,9
SP0068-0476-PM	6,8	8	113	69	47,6
SP0069-0483-PM	6,9	8	113	69	48,3
SP0070-0490-PM	7,0	8	113	69	49,0
SP0071-0497-PM	7,1	8	113	69	49,7
SP0072-0504-PM	7,2	8	113	69	50,4
SP0073-0511-PM	7,3	8	113	69	51,1
SP0074-0518-PM	7,4	8	113	69	51,8
SP0075-0525-PM	7,5	8	113	69	52,5
SP0076-0532-PM	7,6	8	119	75	53,2
SP0077-0539-PM	7,7	8	119	75	53,9
SP0078-0546-PM	7,8	8	119	75	54,6
SP0079-0553-PM	7,9	8	119	75	55,3
SP0080-0560-PM	8,0	8	119	75	56,0
SP0081-0567-PM	8,1	10	125	75	56,7
SP0082-0574-PM	8,2	10	125	75	57,4
SP0083-0581-PM	8,3	10	125	75	58,1
SP0084-0588-PM	8,4	10	125	75	58,8
SP0085-0595-PM	8,5	10	125	75	59,5
SP0086-0602-PM	8,6	10	131	81	60,2
SP0087-0609-PM	8,7	10	131	81	60,9
SP0088-0616-PM	8,8	10	131	81	61,6
SP0089-0623-PM	8,9	10	131	81	62,3
SP0090-0630-PM	9,0	10	131	81	63,0
SP0091-0637-PM	9,1	10	131	81	63,7
SP0092-0644-PM	9,2	10	131	81	64,4
SP0093-0651-PM	9,3	10	131	81	65,1
SP0094-0658-PM	9,4	10	131	81	65,8
SP0095-0665-PM	9,5	10	131	81	66,5
SP0096-0672-PM	9,6	10	137	87	67,2
SP0097-0679-PM	9,7	10	137	87	67,9
SP0098-0686-PM	9,8	10	137	87	68,6
SP0099-0693-PM	9,9	10	137	87	69,3
SP0100-0700-PM	10,0	10	137	87	70,0
SP0101-0707-PM	10,1	12	144	87	70,7
SP0102-0714-PM	10,2	12	144	87	71,4
SP0103-0721-PM	10,3	12	144	87	72,1
SP0104-0728-PM	10,4	12	144	87	72,8
SP0105-0735-PM	10,5	12	144	87	73,5
SP0106-0742-PM	10,6	12	144	87	74,2
SP0107-0749-PM	10,7	12	151	94	74,9
SP0108-0756-PM	10,8	12	151	94	75,6
SP0109-0763-PM	10,9	12	151	94	76,3
SP0110-0770-PM	11,0	12	151	94	77,0
SP0111-0777-PM	11,1	12	151	94	77,7
SP0112-0784-PM	11,2	12	151	94	78,4
SP0113-0791-PM	11,3	12	151	94	79,1
SP0114-0798-PM	11,4	12	151	94	79,8
SP0115-0805-PM	11,5	12	151	94	80,5
SP0116-0812-PM	11,6	12	151	94	81,2
SP0117-0819-PM	11,7	12	151	94	81,9
SP0118-0826-PM	11,8	12	151	94	82,6
SP0119-0833-PM	11,9	12	158	101	83,3

Bezeichnung Designation Articolo	d ₁ m7	d ₂ h6	l ₁	l ₂	l ₃
SP0120-0840-PM	12,0	12	158	101	84,0
SP0121-0847-PM	12,1	12	158	101	84,7
SP0122-0854-PM	12,2	12	158	101	85,4
SP0123-0861-PM	12,3	12	158	101	86,1
SP0124-0868-PM	12,4	12	158	101	86,8
SP0125-0875-PM	12,5	12	158	101	87,5
SP0126-0882-PM	12,6	12	158	101	88,2
SP0127-0889-PM	12,7	12	158	101	88,9
SP0128-0896-PM	12,8	12	158	101	89,6
SP0129-0903-PM	12,9	12	158	101	90,3
SP0130-0910-PM	13,0	12	158	101	91,0



Vollhartmetall-Spiralbohrer

Solid carbide drills

Punta elicoidale in metallo duro

lange Ausführung, mit Innenkühlung

long design, with through tool coolant
versione lunga, con raffreddamento interno

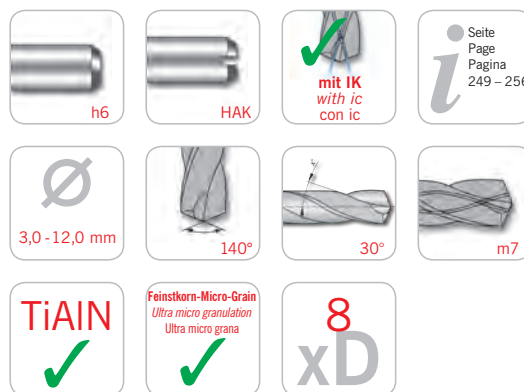

8 x D Ausführung Execution / Versione

Bezeichnung Designation Articolo	d ₁ m7	d ₂ h6	l ₁	l ₂	l ₃
SPC0030-0240	3,0	6	72	34	24,0
SPC0031-0248	3,1	6	72	34	24,8
SPC0032-0256	3,2	6	72	34	25,6
SPC0033-0264	3,3	6	72	34	26,4
SPC0034-0272	3,4	6	72	34	27,2
SPC0035-0280	3,5	6	72	34	28,0
SPC0036-0288	3,6	6	72	34	28,8
SPC0037-0296	3,7	6	72	34	29,6
SPC0038-0304	3,8	6	81	43	30,4
SPC0039-0312	3,9	6	81	43	31,2
SPC0040-0320	4,0	6	81	43	32,0
SPC0041-0328	4,1	6	81	43	32,8
SPC0042-0336	4,2	6	81	43	33,6
SPC0043-0344	4,3	6	81	43	34,4
SPC0044-0352	4,4	6	81	43	35,2
SPC0045-0360	4,5	6	81	43	36,0
SPC0046-0368	4,6	6	81	43	36,8
SPC0047-0376	4,7	6	81	43	37,6
SPC0048-0384	4,8	6	95	57	38,4
SPC0049-0392	4,9	6	95	57	39,2
SPC0050-0400	5,0	6	95	57	40,0
SPC0051-0408	5,1	6	95	57	40,8
SPC0052-0416	5,2	6	95	57	41,6
SPC0053-0424	5,3	6	95	57	42,4
SPC0054-0432	5,4	6	95	57	43,2
SPC0055-0440	5,5	6	95	57	44,0
SPC0056-0448	5,6	6	95	57	44,8
SPC0057-0456	5,7	6	95	57	45,6
SPC0058-0464	5,8	6	95	57	46,4
SPC0059-0472	5,9	6	95	57	47,2
SPC0060-0480	6,0	6	95	57	48,0
SPC0061-0488	6,1	8	114	76	48,8
SPC0062-0496	6,2	8	114	76	49,6
SPC0063-0504	6,3	8	114	76	50,4
SPC0064-0512	6,4	8	114	76	51,2
SPC0065-0520	6,5	8	114	76	52,0
SPC0066-0528	6,6	8	114	76	52,8
SPC0067-0536	6,7	8	114	76	53,6
SPC0068-0544	6,8	8	114	76	54,4
SPC0069-0552	6,9	8	114	76	55,2
SPC0070-0560	7,0	8	114	76	56,0
SPC0071-0568	7,1	8	114	76	56,8
SPC0072-0576	7,2	8	114	76	57,6
SPC0073-0584	7,3	8	114	76	58,4

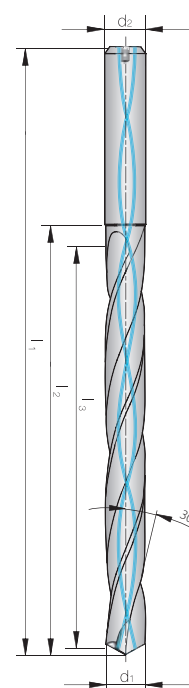

5

8 x D Ausführung Execution / Versione

Bezeichnung Designation Articolo	d ₁ m7	d ₂ h6	l ₁	l ₂	l ₃
SPC0074-0592	7,4	8	114	76	59,2
SPC0075-0600	7,5	8	114	76	60,0
SPC0076-0608	7,6	8	114	76	60,8
SPC0077-0616	7,7	8	114	76	61,6
SPC0078-0624	7,8	8	114	76	62,4
SPC0079-0632	7,9	8	114	76	63,2
SPC0080-0640	8,0	8	114	76	64,0
SPC0081-0648	8,1	10	142	95	64,8
SPC0082-0656	8,2	10	142	95	65,6
SPC0083-0664	8,3	10	142	95	66,4
SPC0084-0672	8,4	10	142	95	67,2
SPC0085-0680	8,5	10	142	95	68,0
SPC0086-0688	8,6	10	142	95	68,8
SPC0087-0696	8,7	10	142	95	69,6
SPC0088-0704	8,8	10	142	95	70,4
SPC0089-0712	8,9	10	142	95	71,2
SPC0090-0720	9,0	10	142	95	72,0
SPC0091-0728	9,1	10	142	95	72,8
SPC0092-0736	9,2	10	142	95	73,6
SPC0093-0744	9,3	10	142	95	74,4
SPC0094-0752	9,4	10	142	95	75,2
SPC0095-0760	9,5	10	142	95	76,0
SPC0096-0768	9,6	10	142	95	76,8
SPC0097-0776	9,7	10	142	95	77,6
SPC0098-0784	9,8	10	142	95	78,4
SPC0099-0792	9,9	10	142	95	79,2
SPC0100-0800	10,0	10	142	95	80,0
SPC0101-0808	10,1	12	162	114	80,8
SPC0102-0816	10,2	12	162	114	81,6
SPC0103-0824	10,3	12	162	114	82,4
SPC0104-0832	10,4	12	162	114	83,2
SPC0105-0840	10,5	12	162	114	84,0
SPC0106-0848	10,6	12	162	114	84,8
SPC0107-0856	10,7	12	162	114	85,6
SPC0108-0864	10,8	12	162	114	86,4
SPC0109-0872	10,9	12	162	114	87,2
SPC0110-0880	11,0	12	162	114	88,0
SPC0111-0888	11,1	12	162	114	88,8
SPC0112-0896	11,2	12	162	114	89,6
SPC0113-0904	11,3	12	162	114	90,4
SPC0114-0912	11,4	12	162	114	91,2
SPC0115-0920	11,5	12	162	114	92,0
SPC0116-0928	11,6	12	162	114	92,8
SPC0117-0936	11,7	12	162	114	93,6
SPC0118-0944	11,8	12	162	114	94,4
SPC0119-0952	11,9	12	162	114	95,2
SPC0120-0960	12,0	12	162	114	96,0



Vollhartmetall-Spiralbohrer

lange Ausführung, mit Innenkühlung, Diamant beschichtet











Solid carbide drills

long design, with through tool coolant, diamond coated

Punta elicoidale in metallo duro

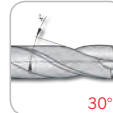
versione lunga, con raffreddamento interno, rivestita Diamante DLC



 h6	 HAK	 mit IK with ic con ic	 Seite Page Pagina 249 - 256
 Ø 3,0 - 14,0 mm	 118°	 30°	 m7
 DIAMANT DIAMANTE	 Feinstkorn-Micro-Grain Ultra micro granulation Ultra micro grana	 ALU	 8 xD

8 x D Ausführung für Aluminium

Execution for aluminium

Versione per Alluminio e leghe non ferrose

Bezeichnung Designation Articolo	d ₁ m7	d ₂ h6	l ₁	l ₂	l ₃
SPC0030-0240-ALU	3,0	6	72	34	24,0
SPC0031-0248-ALU	3,1	6	72	34	24,8
SPC0032-0256-ALU	3,2	6	72	34	25,6
SPC0033-0264-ALU	3,3	6	72	34	26,4
SPC0034-0272-ALU	3,4	6	72	34	27,2
SPC0035-0280-ALU	3,5	6	72	34	28,0
SPC0036-0288-ALU	3,6	6	72	34	28,8
SPC0037-0296-ALU	3,7	6	72	34	29,6
SPC0038-0304-ALU	3,8	6	81	43	30,4
SPC0039-0312-ALU	3,9	6	81	43	31,2
SPC0040-0320-ALU	4,0	6	81	43	32,0
SPC0041-0328-ALU	4,1	6	81	43	32,8
SPC0042-0336-ALU	4,2	6	81	43	33,6
SPC0043-0344-ALU	4,3	6	81	43	34,4
SPC0044-0352-ALU	4,4	6	81	43	35,2
SPC0045-0360-ALU	4,5	6	81	43	36,0
SPC0046-0368-ALU	4,6	6	81	43	36,8
SPC0047-0376-ALU	4,7	6	81	43	37,6
SPC0048-0384-ALU	4,8	6	95	57	38,4
SPC0049-0392-ALU	4,9	6	95	57	39,2
SPC0050-0400-ALU	5,0	6	95	57	40,0
SPC0051-0408-ALU	5,1	6	95	57	40,8
SPC0052-0416-ALU	5,2	6	95	57	41,6
SPC0053-0424-ALU	5,3	6	95	57	42,4
SPC0054-0432-ALU	5,4	6	95	57	43,2
SPC0055-0440-ALU	5,5	6	95	57	44,0
SPC0056-0448-ALU	5,6	6	95	57	44,8
SPC0057-0456-ALU	5,7	6	95	57	45,6
SPC0058-0464-ALU	5,8	6	95	57	46,4
SPC0059-0472-ALU	5,9	6	95	57	47,2
SPC0060-0480-ALU	6,0	6	95	57	48,0
SPC0061-0488-ALU	6,1	8	114	76	48,8
SPC0062-0496-ALU	6,2	8	114	76	49,6
SPC0063-0504-ALU	6,3	8	114	76	50,4
SPC0064-0512-ALU	6,4	8	114	76	51,2
SPC0065-0520-ALU	6,5	8	114	76	52,0
SPC0066-0528-ALU	6,6	8	114	76	52,8
SPC0067-0536-ALU	6,7	8	114	76	53,6
SPC0068-0544-ALU	6,8	8	114	76	54,4
SPC0069-0552-ALU	6,9	8	114	76	55,2
SPC0070-0560-ALU	7,0	8	114	76	56,0
SPC0071-0568-ALU	7,1	8	114	76	56,8

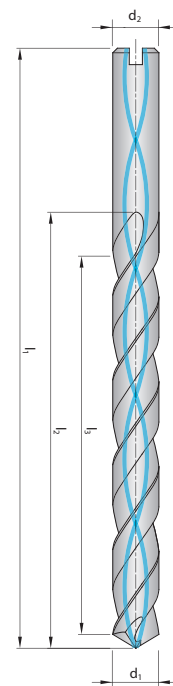

5

8 x D Ausführung für Aluminium*Execution for aluminium*

Versione per Alluminio e leghe non ferrose

Bezeichnung Designation Articolo	d ₁ m7	d ₂ h6	l ₁	l ₂	l ₃
SPC0072-0576-ALU	7,2	8	114	76	57,6
SPC0073-0584-ALU	7,3	8	114	76	58,4
SPC0074-0592-ALU	7,4	8	114	76	59,2
SPC0075-0600-ALU	7,5	8	114	76	60,0
SPC0076-0608-ALU	7,6	8	114	76	60,8
SPC0077-0616-ALU	7,7	8	114	76	61,6
SPC0078-0624-ALU	7,8	8	114	76	62,4
SPC0079-0632-ALU	7,9	8	114	76	63,2
SPC0080-0640-ALU	8,0	8	114	76	64,0
SPC0081-0648-ALU	8,1	10	142	95	64,8
SPC0082-0656-ALU	8,2	10	142	95	65,6
SPC0083-0664-ALU	8,3	10	142	95	66,4
SPC0084-0672-ALU	8,4	10	142	95	67,2
SPC0085-0680-ALU	8,5	10	142	95	68,0
SPC0086-0688-ALU	8,6	10	142	95	68,8
SPC0087-0696-ALU	8,7	10	142	95	69,6
SPC0088-0704-ALU	8,8	10	142	95	70,4
SPC0089-0712-ALU	8,9	10	142	95	71,2
SPC0090-0720-ALU	9,0	10	142	95	72,0
SPC0091-0728-ALU	9,1	10	142	95	72,8
SPC0092-0736-ALU	9,2	10	142	95	73,6
SPC0093-0744-ALU	9,3	10	142	95	74,4
SPC0094-0752-ALU	9,4	10	142	95	75,2
SPC0095-0760-ALU	9,5	10	142	95	76,0
SPC0096-0768-ALU	9,6	10	142	95	76,8
SPC0097-0776-ALU	9,7	10	142	95	77,6
SPC0098-0784-ALU	9,8	10	142	95	78,4
SPC0099-0792-ALU	9,9	10	142	95	79,2
SPC0100-0800-ALU	10,0	10	142	95	80,0
SPC0101-0808-ALU	10,1	12	162	114	80,8
SPC0102-0816-ALU	10,2	12	162	114	81,6
SPC0103-0824-ALU	10,3	12	162	114	82,4
SPC0104-0832-ALU	10,4	12	162	114	83,2
SPC0105-0840-ALU	10,5	12	162	114	84,0
SPC0106-0848-ALU	10,6	12	162	114	84,8
SPC0107-0856-ALU	10,7	12	162	114	85,6
SPC0108-0864-ALU	10,8	12	162	114	86,4
SPC0109-0872-ALU	10,9	12	162	114	87,2
SPC0110-0880-ALU	11,0	12	162	114	88,0
SPC0111-0888-ALU	11,1	12	162	114	88,8
SPC0112-0896-ALU	11,2	12	162	114	89,6
SPC0113-0904-ALU	11,3	12	162	114	90,4
SPC0114-0912-ALU	11,4	12	162	114	91,2
SPC0115-0920-ALU	11,5	12	162	114	92,0
SPC0116-0928-ALU	11,6	12	162	114	92,8
SPC0117-0936-ALU	11,7	12	162	114	93,6
SPC0118-0944-ALU	11,8	12	162	114	94,4
SPC0119-0952-ALU	11,9	12	162	114	95,2
SPC0120-0960-ALU	12,0	12	162	114	96,0
SPC0125-1000-ALU	12,5	14	178	133	100,0
SPC0130-1040-ALU	13,0	14	178	133	104,0
SPC0135-1080-ALU	13,5	14	178	133	108,0
SPC0140-1120-ALU	14,0	14	178	133	112,0

Vollhartmetall-Spiralbohrer

Solid carbide drills

Punta elicoidale in metallo duro

lange Ausführung, mit Innenkühlung

long design, with through tool coolant
versione lunga, con raffreddamento interno

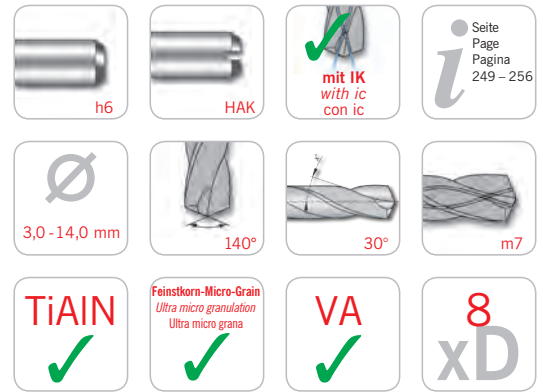

8 x D Ausführung für rostfreie Stähle

Execution for stainless steel

Versione per Acciai Inossidabili

Bezeichnung Designation Articolo	d ₁ m7	d ₂ h6	l ₁	l ₂	l ₃
SPC0030-0240-VA	3,0	6	72	34	24,0
SPC0031-0248-VA	3,1	6	72	34	24,8
SPC0032-0256-VA	3,2	6	72	34	25,6
SPC0033-0264-VA	3,3	6	72	34	26,4
SPC0034-0272-VA	3,4	6	72	34	27,2
SPC0035-0280-VA	3,5	6	72	34	28,0
SPC0036-0288-VA	3,6	6	72	34	28,8
SPC0037-0296-VA	3,7	6	72	34	29,6
SPC0038-0304-VA	3,8	6	81	43	30,4
SPC0039-0312-VA	3,9	6	81	43	31,2
SPC0040-0320-VA	4,0	6	81	43	32,0
SPC0041-0328-VA	4,1	6	81	43	32,8
SPC0042-0336-VA	4,2	6	81	43	33,6
SPC0043-0344-VA	4,3	6	81	43	34,4
SPC0044-0352-VA	4,4	6	81	43	35,2
SPC0045-0360-VA	4,5	6	81	43	36,0
SPC0046-0368-VA	4,6	6	81	43	36,8
SPC0047-0376-VA	4,7	6	81	43	37,6
SPC0048-0384-VA	4,8	6	95	57	38,4
SPC0049-0392-VA	4,9	6	95	57	39,2
SPC0050-0400-VA	5,0	6	95	57	40,0
SPC0051-0408-VA	5,1	6	95	57	40,8
SPC0052-0416-VA	5,2	6	95	57	41,6
SPC0053-0424-VA	5,3	6	95	57	42,4
SPC0054-0432-VA	5,4	6	95	57	43,2
SPC0055-0440-VA	5,5	6	95	57	44,0
SPC0056-0448-VA	5,6	6	95	57	44,8
SPC0057-0456-VA	5,7	6	95	57	45,6
SPC0058-0464-VA	5,8	6	95	57	46,4
SPC0059-0472-VA	5,9	6	95	57	47,2
SPC0060-0480-VA	6,0	6	95	57	48,0
SPC0061-0488-VA	6,1	8	114	76	48,8
SPC0062-0496-VA	6,2	8	114	76	49,6
SPC0063-0504-VA	6,3	8	114	76	50,4
SPC0064-0512-VA	6,4	8	114	76	51,2
SPC0065-0520-VA	6,5	8	114	76	52,0
SPC0066-0528-VA	6,6	8	114	76	52,8
SPC0067-0536-VA	6,7	8	114	76	53,6
SPC0068-0544-VA	6,8	8	114	76	54,4
SPC0069-0552-VA	6,9	8	114	76	55,2
SPC0070-0560-VA	7,0	8	114	76	56,0
SPC0071-0568-VA	7,1	8	114	76	56,8

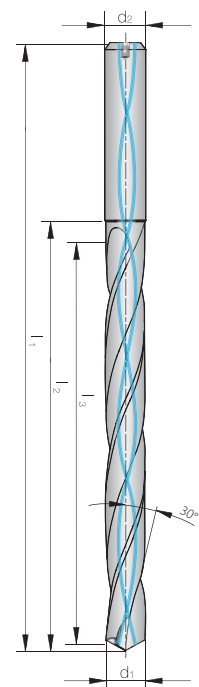

5

8 x D Ausführung für rostfreie Stähle

Execution for stainless steel

Versione per Acciai Inossidabili

Bezeichnung Designation Articolo	d ₁ m7	d ₂ h6	l ₁	l ₂	l ₃
SPC0072-0576-VA	7,2	8	114	76	57,6
SPC0073-0584-VA	7,3	8	114	76	58,4
SPC0074-0592-VA	7,4	8	114	76	59,2
SPC0075-0600-VA	7,5	8	114	76	60,0
SPC0076-0608-VA	7,6	8	114	76	60,8
SPC0077-0616-VA	7,7	8	114	76	61,6
SPC0078-0624-VA	7,8	8	114	76	62,4
SPC0079-0632-VA	7,9	8	114	76	63,2
SPC0080-0640-VA	8,0	8	114	76	64,0
SPC0081-0648-VA	8,1	10	142	95	64,8
SPC0082-0656-VA	8,2	10	142	95	65,6
SPC0083-0664-VA	8,3	10	142	95	66,4
SPC0084-0672-VA	8,4	10	142	95	67,2
SPC0085-0680-VA	8,5	10	142	95	68,0
SPC0086-0688-VA	8,6	10	142	95	68,8
SPC0087-0696-VA	8,7	10	142	95	69,6
SPC0088-0704-VA	8,8	10	142	95	70,4
SPC0089-0712-VA	8,9	10	142	95	71,2
SPC0090-0720-VA	9,0	10	142	95	72,0
SPC0091-0728-VA	9,1	10	142	95	72,8
SPC0092-0736-VA	9,2	10	142	95	73,6
SPC0093-0744-VA	9,3	10	142	95	74,4
SPC0094-0752-VA	9,4	10	142	95	75,2
SPC0095-0760-VA	9,5	10	142	95	76,0
SPC0096-0768-VA	9,6	10	142	95	76,8
SPC0097-0776-VA	9,7	10	142	95	77,6
SPC0098-0784-VA	9,8	10	142	95	78,4
SPC0099-0792-VA	9,9	10	142	95	79,2
SPC0100-0800-VA	10,0	10	142	95	80,0
SPC0101-0808-VA	10,1	12	162	114	80,8
SPC0102-0816-VA	10,2	12	162	114	81,6
SPC0103-0824-VA	10,3	12	162	114	82,4
SPC0104-0832-VA	10,4	12	162	114	83,2
SPC0105-0840-VA	10,5	12	162	114	84,0
SPC0106-0848-VA	10,6	12	162	114	84,8
SPC0107-0856-VA	10,7	12	162	114	85,6
SPC0108-0864-VA	10,8	12	162	114	86,4
SPC0109-0872-VA	10,9	12	162	114	87,2
SPC0110-0880-VA	11,0	12	162	114	88,0
SPC0111-0888-VA	11,1	12	162	114	88,8
SPC0112-0896-VA	11,2	12	162	114	89,6
SPC0113-0904-VA	11,3	12	162	114	90,4
SPC0114-0912-VA	11,4	12	162	114	91,2
SPC0115-0920-VA	11,5	12	162	114	92,0
SPC0116-0928-VA	11,6	12	162	114	92,8
SPC0117-0936-VA	11,7	12	162	114	93,6
SPC0118-0944-VA	11,8	12	162	114	94,4
SPC0119-0952-VA	11,9	12	162	114	95,2
SPC0120-0960-VA	12,0	12	162	114	96,0
SPC0125-1000-VA	12,5	14	178	133	100,0
SPC0130-1040-VA	13,0	14	178	133	104,0
SPC0135-1080-VA	13,5	14	178	133	108,0
SPC0140-1120-VA	14,0	14	178	133	112,0



Vollhartmetall-Spiralbohrer

Solid carbide drills

Punta elicoidale in metallo duro

extra lange Ausführung, mit Innenkühlung

extra long design, with through tool coolant
versione extra lunga, con raffreddamento interno



h6	HAK	mit IK with ic con ic	Seite Page Pagina 249 - 256
3,0 - 14,0 mm	140°	30°	m7
TiAlN	Feinstkorn-Micro-Grain Ultra micro granulation Ultra micro grana	10 xD	

10 x D Ausführung

Execution / Versione

Bezeichnung Designation Articolo	d ₁ m7	d ₂ h6	l ₁	l ₂	l ₃
SPC0030-0300	3,0	3	90	39	30,0
SPC0033-0330	3,3	4	97	46	33,0
SPC0035-0350	3,5	4	97	46	35,0
SPC0040-0400	4,0	4	103	52	40,0
SPC0042-0420	4,2	5	112	59	42,0
SPC0045-0450	4,5	5	112	59	45,0
SPC0050-0500	5,0	5	118	65	50,0
SPC0055-0550	5,5	6	127	72	55,0
SPC0060-0600	6,0	6	133	78	60,0
SPC0065-0650	6,5	7	141	85	65,0
SPC0068-0680	6,8	7	147	91	68,0
SPC0070-0700	7,0	7	147	91	70,0
SPC0075-0750	7,5	8	155	98	75,0
SPC0080-0800	8,0	8	161	104	80,0
SPC0085-0850	8,5	9	169	11	85,0
SPC0090-0900	9,0	9	175	117	90,0
SPC0095-0950	9,5	10	182	124	95,0
SPC0100-1000	10,0	10	188	130	100,0
SPC0105-1050	10,5	11	201	137	105,0
SPC0110-1100	11,0	11	207	143	110,0
SPC0115-1150	11,5	12	215	150	115,0
SPC0120-1200	12,0	12	221	156	120,0
SPC0125-1250	12,5	13	229	163	125,0
SPC0130-1300	13,0	13	235	169	130,0
SPC0135-1350	13,5	14	243	176	135,0
SPC0140-1400	14,0	14	249	182	140,0

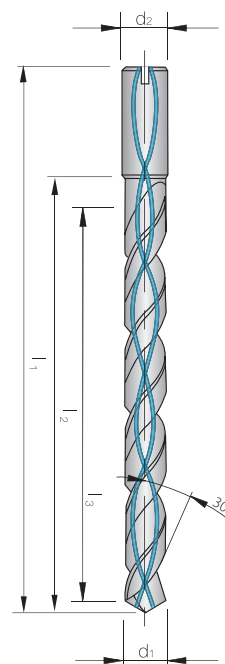

5

Vollhartmetall-Spiralbohrer

Solid carbide drills

Punta elicoidale in metallo duro

extra lange Ausführung, mit Innenkühlung

extra long design, with through tool coolant

versione extra lunga, con raffreddamento interno

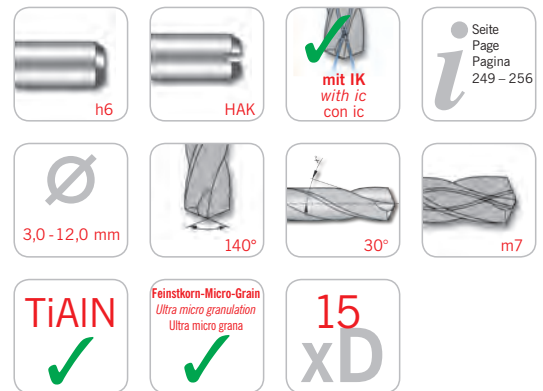

15 x D Ausführung

Execution / Versione

Bezeichnung Designation Articolo	d ₁ m7	d ₂ h6	l ₁	l ₂	l ₃
SPC0030-0450	3,0	3	105	54	45,0
SPC0035-0525	3,5	4	114	63	52,5
SPC0040-0600	4,0	4	123	72	60,0
SPC0045-0675	4,5	5	134	81	67,5
SPC0050-0750	5,0	5	143	90	75,0
SPC0055-0825	5,5	6	154	99	82,5
SPC0060-0900	6,0	6	163	108	90,0
SPC0070-1050	7,0	7	182	126	105,0
SPC0080-1200	8,0	8	201	144	120,0
SPC0090-1350	9,0	9	220	162	135,0
SPC0100-1500	10,0	10	238	180	150,0
SPC0110-1650	11,0	11	262	198	165,0
SPC0120-1800	12,0	12	281	216	180,0

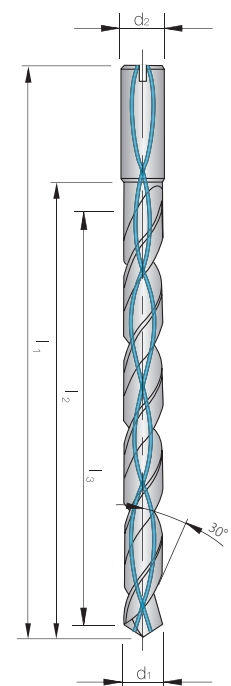

Vollhartmetall-Spiralbohrer

Solid carbide drills

Punta elicoidale in metallo duro

extra lange Ausführung, mit Innenkühlung

extra long design, with through tool coolant

versione extra lunga, con raffreddamento interno



h6	HAK	mit IK with ic con ic	Seite Page Pagina 249 - 256
3,0 - 12,0 mm	140°	30°	m7
TiAlN	Feinstkorn-Micro-Grain Ultra micro granulation Ultra micro grana	20 xD	

20 x D Ausführung

Execution / Versione

Bezeichnung Designation Articolo	d ₁ m7	d ₂ h6	l ₁	l ₂	l ₃
SPC0030-0600	3,0	3	120	69	60,0
SPC0035-0700	3,5	4	132	81	70,0
SPC0040-0800	4,0	4	143	92	80,0
SPC0045-0900	4,5	5	157	104	90,0
SPC0050-1000	5,0	5	168	115	100,0
SPC0055-1100	5,5	6	182	127	110,0
SPC0060-1200	6,0	6	193	138	120,0
SPC0070-1400	7,0	7	217	161	140,0
SPC0080-1600	8,0	8	241	184	160,0
SPC0090-1800	9,0	9	265	207	180,0
SPC0100-2000	10,0	10	288	230	200,0
SPC0120-2400	12,0	12	341	276	240,0

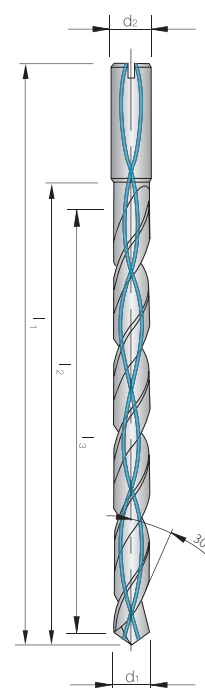

Vollhartmetall NC-Anbohrer

Solid carbide NC spot drills
Punta da centro in MD integrale

2 Schneiden, 90°

2 flutes, 90°
2 taglienti, 90°



NC-Anbohrer 90°

NC spot drill 90° / Punta da centro 90°

Bezeichnung Designation Articolo	d_1 h6	d_2 h6	l_1	l_2	A
SPA0020-090	2,0	2	40	8	90°
SPA0030-090	3,0	3	40	10	90°
SPA0040-090	4,0	4	40	12	90°
SPA0050-090	5,0	5	50	15	90°
SPA0060-090	6,0	6	50	20	90°
SPA0080-090	8,0	8	63	22	90°
SPA0100-090	10,0	10	74	23	90°
SPA0120-090	12,0	12	83	25	90°
SPA0140-090	14,0	14	83	26	90°
SPA0160-090	16,0	16	92	28	90°
SPA0180-090	18,0	18	92	30	90°
SPA0200-090	20,0	20	104	30	90°

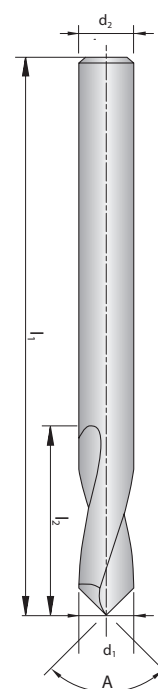

5

Vollhartmetall NC-Anbohrer

Solid carbide NC spot drills
Punta da centro in MD integrale

2 Schneiden, 120°

2 flutes, 120°
2 taglienti, 120°



NC-Anbohrer 120°

NC spot drill 120° / Punta da centro 120°

Bezeichnung Designation Articolo	d_1 h6	d_2 h6	l_1	l_2	A
SPA0020-120	2,0	2	40	8	120°
SPA0030-120	3,0	3	40	10	120°
SPA0040-120	4,0	4	40	12	120°
SPA0050-120	5,0	5	50	15	120°
SPA0060-120	6,0	6	50	20	120°
SPA0080-120	8,0	8	63	22	120°
SPA0100-120	10,0	10	74	23	120°
SPA0120-120	12,0	12	83	25	120°
SPA0140-120	14,0	14	83	26	120°
SPA0160-120	16,0	16	92	28	120°
SPA0180-120	18,0	18	92	30	120°
SPA0200-120	20,0	20	104	30	120°

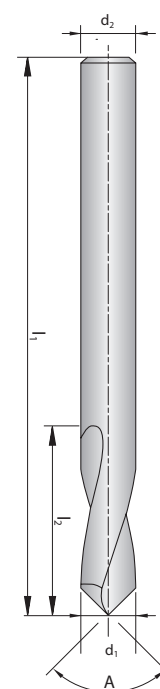

Vollhartmetall NC-Anbohrer

Solid carbide NC spot drills
Punta da centro in MD integrale

2 Schneiden, 135°

2 flutes, 135°
2 taglienti, 135°



NC-Anbohrer 135°

NC spot drill 135° / Punta da centro 135°

Bezeichnung Designation Articolo	d_1 h6	d_2 h6	l_1	l_2	A
SPA0120-135	12,0	12	83	25	135°
SPA0160-135	16,0	16	92	28	135°
SPA0200-135	20,0	20	104	30	135°

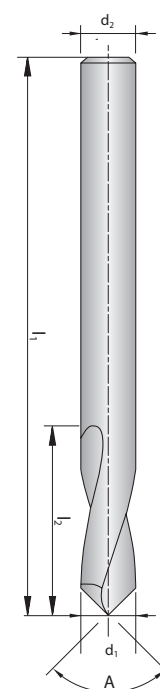

PM-HSS NC-Anbohrer

Powder metal NC spot drills
Punta da centro HSS-PM

2 Schneiden, 90°

2 flutes, 90°
2 taglienti, 90°

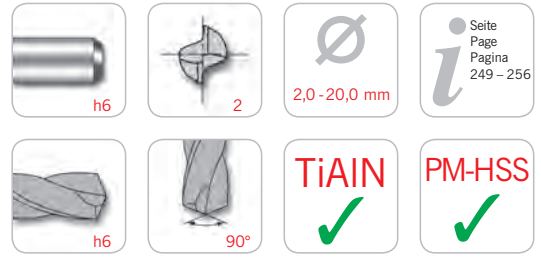

NC-Anbohrer 90°

NC spot drill 90° / Punta da centro 90°

Bezeichnung Designation Articolo	d_1 h6	d_2 h6	l_1	l_2	A
SPA0020-090-PM	2,0	2	40	8	90°
SPA0030-090-PM	3,0	3	40	10	90°
SPA0040-090-PM	4,0	4	40	12	90°
SPA0050-090-PM	5,0	5	50	15	90°
SPA0060-090-PM	6,0	6	50	20	90°
SPA0080-090-PM	8,0	8	63	22	90°
SPA0100-090-PM	10,0	10	74	23	90°
SPA0120-090-PM	12,0	12	83	25	90°
SPA0140-090-PM	14,0	14	83	26	90°
SPA0160-090-PM	16,0	16	92	28	90°
SPA0180-090-PM	18,0	18	92	30	90°
SPA0200-090-PM	20,0	20	104	30	90°

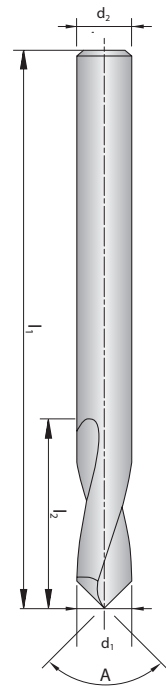

PM-HSS NC-Anbohrer

Powder metal NC spot drills
Punta da centro HSS-PM

2 Schneiden, 120°

2 flutes, 120°
2 taglienti, 120°



NC-Anbohrer 120°

NC spot drill 120° / Punta da centro 120°

Bezeichnung Designation Articolo	d_1 h6	d_2 h6	l_1	l_2	A
SPA0020-120-PM	2,0	2	40	8	120°
SPA0030-120-PM	3,0	3	40	10	120°
SPA0040-120-PM	4,0	4	40	12	120°
SPA0050-120-PM	5,0	5	50	15	120°
SPA0060-120-PM	6,0	6	50	20	120°
SPA0080-120-PM	8,0	8	63	22	120°
SPA0100-120-PM	10,0	10	74	23	120°
SPA0120-120-PM	12,0	12	83	25	120°
SPA0140-120-PM	14,0	14	83	26	120°
SPA0160-120-PM	16,0	16	92	28	120°
SPA0180-120-PM	18,0	18	92	30	120°
SPA0200-120-PM	20,0	20	104	30	120°

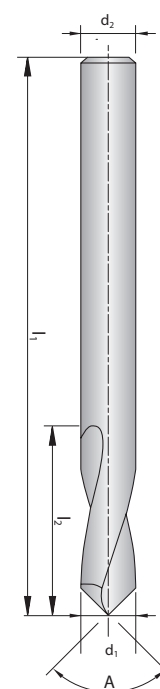

5

PM-HSS NC-Anbohrer

Powder metal NC spot drills
Punta da centro HSS-PM

2 Schneiden, 135°

2 flutes, 135°
2 taglienti, 135°

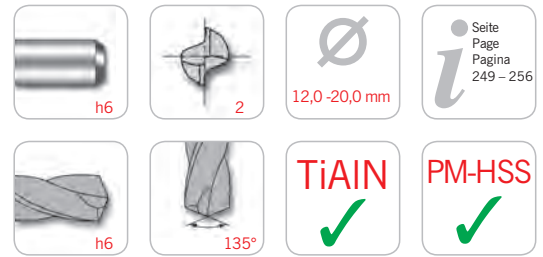

NC-Anbohrer 135°

NC spot drill 135° / Punta da centro 135°

Bezeichnung Designation Articolo	d_1 h6	d_2 h6	l_1	l_2	A
SPA0120-135-PM	12,0	12	83	25	135°
SPA0160-135-PM	16,0	16	92	28	135°
SPA0200-135-PM	20,0	20	104	30	135°

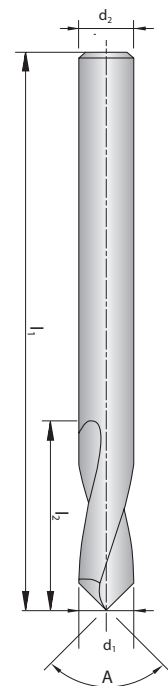

Vollhartmetall Zentrierer

Solid carbide centre drills

Punta da centro per contropunta in MD integrale

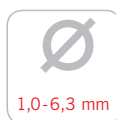
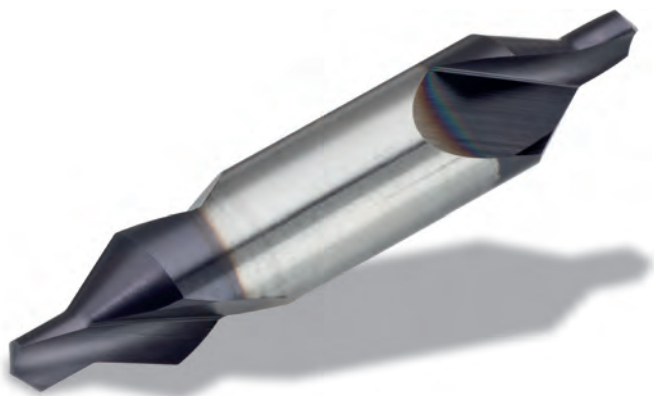

Zentrierbohrer

Centre drill DIN 333, Form A

Punta da centro DIN 333, Forma A

Bezeichnung Designation Articolo	d_1	d_2 h_6	l_1	l_2
SPZ0100-0016	1,0	3,15	31,5	1,6
SPZ0125-0019	1,25	3,15	31,5	1,9
SPZ0160-0024	1,6	4,00	35,5	2,4
SPZ0200-0029	2,0	5,00	40	2,9
SPZ0250-0036	2,5	6,30	45	3,6
SPZ0315-0044	3,15	8,00	50	4,4
SPZ0400-0056	4,0	10,00	56	5,6
SPZ0500-0069	5,0	12,50	63	6,9
SPZ0630-0086	6,3	16,00	71	8,6

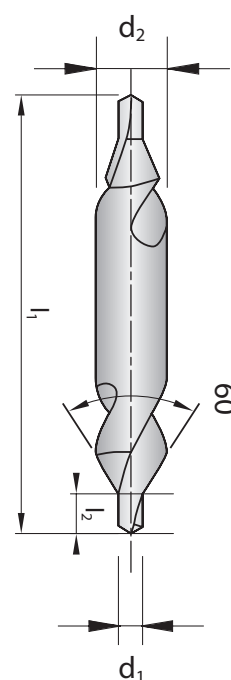

PM-HSS Zentrierer

Powder metal centre drills

Punta da centro per contropunta in HSS-PM



Zentrierbohrer

Centre drill DIN 333, Form A

Punta da centro DIN 333, Forma A

Bezeichnung Designation Articolo	d_1	d_2 h_6	l_1	l_2
SPZ0100-0016-PM	1,0	3,15	31,5	1,6
SPZ0125-0019-PM	1,25	3,15	31,5	1,9
SPZ0160-0024-PM	1,6	4,00	35,5	2,4
SPZ0200-0029-PM	2,0	5,00	40,0	2,9
SPZ0250-0036-PM	2,5	6,30	45,0	3,6
SPZ0315-0044-PM	3,15	8,00	50,0	4,4
SPZ0400-0056-PM	4,0	10,00	56,0	5,6
SPZ0500-0069-PM	5,0	12,50	63,0	6,9
SPZ0630-0086-PM	6,3	16,00	71,0	8,6

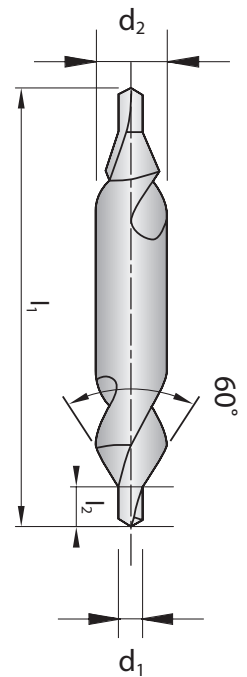

Vollhartmetall-Bohrer TiAlN-beschichtet (ohne Innenkühlung)

Solid carbide drills TiAlN coated (without internal coolant)

Punte in metallo duro rivestite TiAlN (senza refrigerazione interna)



Empfohlene Schnittwerte 3xD / 5xD / Cutting datas / Parametri di taglio

Werkstoff / Material / Materiale	Zugfestigkeit Tensile strength Durezza [N/mm ²]	V _c [m/min] V _c [m/rev] V _c [m/min]	Durchmesser / Diameter / Diametro [mm]						
			1~3 f [mm/U]	3~5 f [mm/U]	5~8 f [mm/U]	8~10 f [mm/U]	10~12 f [mm/U]	12~14 f [mm/U]	14~20 f [mm/U]
Kupfer und Kupferlegierungen (Bronze / Messing) <i>Copper and copper alloys (brass / bronze)</i> Rame e leghe di Rame (Ottone / Bronzo)	-	60-170	0,02-0,16	0,06-0,18	0,10-0,20	0,18-0,30	0,25-0,35	0,30-0,38	0,30-0,50
Aluminium hoher Si-Gehalt <i>Aluminium - high Si-content</i> Alluminio con alto contenuto di Silicio	-	60-179	0,05-0,10	0,10-0,20	0,15-0,30	0,20-0,30	0,25-0,35	0,25-0,35	0,30-0,50
Aluminium niedriger Si-Gehalt <i>Aluminium - low Si-content</i> Alluminio a basso contenuto di Silicio	-	70-260	0,05-0,10	0,10-0,20	0,15-0,30	0,20-0,30	0,25-0,35	0,25-0,35	0,30-0,50
Titanlegierungen <i>Titanium alloys</i> Leghe di Titanio	-	13-32	0,01-0,04	0,03-0,07	0,06-0,12	0,06-0,12	0,08-0,15	0,08-0,15	0,10-0,16
Hochtemperaturlegierungen <i>High Temperature alloys</i> Leghe per alte temperature	> 1000	13-27	0,02-0,06	0,03-0,07	0,04-0,08	0,06-0,10	0,08-0,14	0,08-0,14	0,08-0,16
Nickellegierungen <i>Nickel alloys</i> Leghe di Nickel	> 1000	13-27	-	-	-	-	-	-	-
„Superlegierungen“ z.B. Inconel Hasteloy Nimonic <i>Super Alloys e.g. Inconel, Hasteloy, Nimonic</i> Super leghe es: Inconel Hasteloy Nimonic	> 1000	13-27	-	-	-	-	-	-	-
Unlegierter Stahl und Stahlguss <i>Unalloyed steel and cast steel</i> Acciaio non legato ed acciaio stampato	< 600	80-102	0,05-0,10	0,10-0,18	0,15-0,25	0,20-0,30	0,20-0,30	0,20-0,35	0,25-0,40
Unlegierter Stahl und Stahlguss <i>Unalloyed steel and cast steel</i> Acciaio non legato ed acciaio stampato	600-900	68-85	0,01-0,10	0,08-0,18	0,15-0,25	0,20-0,30	0,20-0,30	0,20-0,35	0,25-0,40
	450-900	55-77	0,05-0,15	0,10-0,20	0,15-0,25	0,18-0,35	0,18-0,35	0,20-0,35	0,25-0,42
Nieder- und hochlegierte Stähle und Stahlguss <i>Low and high alloyed steels and cast steel</i> Acciaio debolmente e fortemente legato ed acciaio stampato	900-1000	43-60	0,06-0,12	0,08-0,15	0,10-0,18	0,15-0,25	0,15-0,25	0,16-0,30	0,20-0,32
	> 1000	37-50	0,06-0,12	0,08-0,15	0,10-0,18	0,15-0,25	0,15-0,25	0,16-0,30	0,20-0,32
Rostfreie Stähle <i>Stainless steels</i> Acciaio inossidabile	500-700	38-50	0,02-0,08	0,04-0,10	0,06-0,12	0,10-0,20	0,10-0,20	0,10-0,20	0,12-0,25
Rostfreie Stähle <i>Stainless steels</i> Acciaio inossidabile	700-1000	30-43	0,02-0,08	0,04-0,10	0,06-0,12	0,10-0,20	0,10-0,20	0,10-0,20	0,12-0,25
Gusseisen, Temperguss <i>Cast iron, malleable cast iron</i> Ghisa grigia, ghisa malleabile	< 700	77-110	0,10-0,15	0,12-0,16	0,15-0,33	0,25-0,45	0,25-0,45	0,30-0,50	0,35-0,55
	850-1000	60-72	0,08-0,15	0,10-0,16	0,12-0,30	0,20-0,40	0,20-0,40	0,25-0,40	0,30-0,45
Hartguss <i>Hard cast iron</i> Ghisa indurita	1170-1500	35-55	0,06-0,10	0,08-0,12	0,08-0,12	0,10-0,14	0,10-0,14	0,12-0,16	0,14-0,18

Achtung:
Bei unbeschichteten Spiralbohrern die Schnittgeschwindigkeiten um ca. 30% reduzieren.

Attention:
Reduce the cutting speed by approximately 30% when using the uncoated drills.

Nota:
Per punte non rivestite, ridurre i parametri di taglio di circa il 30%.

Achtung:
Die obigen Empfehlungen gelten für Bohrer bis Bohrtiefe 3 x D. Bitte reduzieren Sie den Vorschub bei 5 x D um den Faktor 0,85.

Attention:
Cutting datas refer to solid carbide drills 3 x D. For using 5 x D please reduce the feed rate by factor 0.85.

Attenzione:
I dati di taglio si riferiscono alle punte in metallo duro 3 x D. Per punte 5 x D prego ridurre l'avanzamento per il fattore 0,85.

Vollhartmetall-Bohrer mit Kühlkanal DIN6537, TiAlN-beschichtetSolid carbide drills *with* coolant DIN6537, TiAlN coatedPunte in metallo duro integrale *con* refrigerazione interna gambo DIN 6537, rivestito TiAlN**Empfohlene Schnittwerte 3xD / 5xD / 8xD / Cutting datas / Parametri di taglio**

Werkstoff / Material / Materiale	Zugfestigkeit Tensile strength Durezza [N/mm ²]	V _c [m/min] V _c [m/rev] V _c [m/min]	Durchmesser / Diameter / Diametro [mm]						
			1~3 f [mm/U]	3~5 f [mm/U]	5~8 f [mm/U]	8~10 f [mm/U]	10~12 f [mm/U]	12~14 f [mm/U]	14~20 f [mm/U]
Kupfer und Kupferlegierungen (Bronze / Messing) <i>Copper and copper alloys (brass / bronze)</i> Rame e leghe di Rame (Ottone / Bronzo)	-	70-200	0,02-0,16	0,06-0,18	0,10-0,20	0,18-0,30	0,25-0,35	0,30-0,38	0,30-0,50
Aluminium hoher Si-Gehalt <i>Aluminium - high Si-content</i> Alluminio con alto contenuto di Silicio	-	70-210	0,05-0,10	0,10-0,20	0,15-0,30	0,20-0,30	0,20-0,35	0,25-0,35	0,30-0,50
Aluminium niedriger Si-Gehalt <i>Aluminium - low Si-content</i> Alluminio a basso contenuto di Silicio	-	80-305	0,05-0,10	0,10-0,20	0,15-0,30	0,20-0,30	0,20-0,35	0,25-0,35	0,30-0,50
Titanlegierungen <i>Titanium alloys</i> Leghe di Titanio	-	15-38	0,01-0,04	0,03-0,07	0,06-0,12	0,06-0,12	0,08-0,15	0,08-0,15	0,10-0,16
Hochtemperaturlegierungen <i>High Temperature alloys</i> Leghe per alte temperature	> 1000	15-32	0,02-0,06	0,03-0,07	0,04-0,08	0,06-0,10	0,08-0,12	0,08-0,14	0,08-0,16
Nickellegierungen <i>Nickel alloys</i> Leghe di Nickel	> 1000	15-32	-	-	-	-	-	-	-
„Superlegierungen“ z.B. Inconel Hasteloy Nimonic <i>Super Alloys e.g. Inconel, Hasteloy, Nimonic</i> Super leghe es: Inconel Hasteloy Nimonic	> 1000	15-32	-	-	-	-	-	-	-
Unlegierter Stahl und Stahlguss <i>Unalloyed steel and cast steel</i> Acciaio non legato ed acciaio stampato	< 600	100-120	0,05-0,10	0,10-0,18	0,15-0,25	0,18-0,28	0,20-0,30	0,20-0,35	0,25-0,40
Unlegierter Stahl und Stahlguss <i>Unalloyed steel and cast steel</i> Acciaio non legato ed acciaio stampato	600-900	80-100	0,05-0,10	0,08-0,18	0,15-0,25	0,18-0,28	0,20-0,30	0,20-0,35	0,25-0,40
	450-900	65-90	0,05-0,15	0,10-0,20	0,15-0,25	0,18-0,30	0,18-0,35	0,20-0,35	0,25-0,42
Nieder- und hochlegierte Stähle und Stahlguss <i>Low and high alloyed steels and cast steel</i> Acciaio debolmente e fortemente legato ed acciaio stampato	900-1000	50-70	0,06-0,12	0,08-0,15	0,10-0,18	0,12-0,20	0,15-0,25	0,16-0,30	0,20-0,32
	> 1000	43-60	0,06-0,12	0,08-0,15	0,10-0,18	0,12-0,20	0,15-0,25	0,16-0,30	0,20-0,32
Rostfreie Stähle <i>Stainless steels</i> Acciaio inossidabile	500-700	45-60	0,02-0,08	0,04-0,10	0,06-0,12	0,10-0,18	0,10-0,20	0,10-0,20	0,12-0,25
Rostfreie Stähle <i>Stainless steels</i> Acciaio inossidabile	700-1000	35-50	0,02-0,08	0,04-0,10	0,06-0,12	0,10-0,18	0,10-0,20	0,10-0,20	0,12-0,25
Gusseisen, Temperguss <i>Cast iron, malleable cast iron</i> Ghisa grigia, ghisa malleabile	< 700	90-130	0,08-0,10	0,12-0,16	0,15-0,33	0,20-0,40	0,25-0,45	0,30-0,50	0,35-0,55
	850-1000	70-85	0,08-0,10	0,10-0,16	0,12-0,30	0,20-0,35	0,20-0,40	0,25-0,40	0,30-0,45
Hartguss <i>Hard cast iron</i> Ghisa indurita	1170-1500	40-65	0,04-0,08	0,06-0,10	0,08-0,12	0,10-0,14	0,10-0,14	0,12-0,16	0,14-0,18

Achtung:

Die obigen Empfehlungen gelten für Bohrer bis Bohrtiefe 3 x D.

Bitte reduzieren Sie den Vorschub bei 5 x D oder 8 x D um den Faktor: 5 x D: 0,85 und 8 x D: 0,70

Attention:

Cutting datas refer to solid carbide drills 3 x D.

For using 5 x D or 8 x D please reduce the feed rate by following factor: 5 x D: 0.85 and 8 x D: 0.70.

Attenzione:

I dati di taglio si riferiscono alle punte in metallo duro 3 x D.

Per punte 5 x D prego ridurre l'avanzamento per il fattore 0,85;

per punte 8 x D prego ridurre l'avanzamento per il fattore 0,70.

PM-HSS Spiralbohrer (ohne Innenkühlung)

Powder metal drills (without internal coolant)

Punta elicoidale in PM-HSS senza refrigerazione interna



Empfohlene Schnittwerte **3 x D / 7 x D** / Cutting datas / Parametri di taglio

Werkstoff / Material / Materiale	V _c [m/min] V _c [m/rev] V _c [m/min]	Durchmesser / Diameter / Diametro [mm]									
		1	2	3	4	5	6	8	10	12	
		f [mm/U]	f [mm/U]	f [mm/U]	f [mm/U]	f [mm/U]	f [mm/U]	f [mm/U]	f [mm/U]	f [mm/U]	f [mm/U]
Baustahl, Kohlenstoffstahl, Automatenstahl <i>Structural steels, Carbon steels, Free machining steels</i> Acciaio da costruzione, Acciaio al carbonio, Acciaio di facile lavorabilità	30–50	0,02	0,06	0,12	0,15	0,16	0,20	0,24	0,27	0,29	
Legierter Stahl, Naturharter Stahl <i>Alloy steels, pre-hardened steels</i> Acciaio legati, Acciaio bonificati	25–32	0,02	0,05	0,09	0,13	0,16	0,18	0,20	0,24	0,26	
Werkzeugstahl, Rostfreier Stahl, gehärteter Stahl 30-45 HRC <i>Tool steels, Stainless steel, Hardened steels HRC 30-45</i> Acciaio da utensili, Acciaio inossidabile, Acciaio indurito fino a 45 HRC	10–16	0,02	0,05	0,09	0,10	0,11	0,14	0,17	0,21	0,23	
Gusseisen <i>Cast iron</i> Ghisa grigia	35–55	0,03	0,08	0,14	0,18	0,21	0,25	0,29	0,32	0,36	
Aluminiumlegierungen, Nichteisenlegierungen <i>Aluminum alloys, non-ferrous alloys</i> Leghe di Alluminio, leghe metalliche non ferrose	50–70	0,04	0,09	0,15	0,18	0,22	0,25	0,30	0,33	0,35	
Hochtemperaturlegierungen, Superlegierungen (Nimonic, Hasteloy, Inconell ...) <i>High temperature alloys, superalloys (Nimonic, Hasteloy, Inconell ...)</i> Superleghe, leghe refrattarie per elevate temperature (Nimonic, Hasteloy, Inconell ...)	3–8	0,01	0,02	0,03	0,04	0,05	0,06	0,08	0,10	0,12	
Titan, Titanlegierungen <i>Titanium, titanium alloys</i> Titanio, leghe di titanio	3–8	0,01	0,02	0,03	0,04	0,05	0,06	0,08	0,10	0,12	
Hardox (Hardox 400/500) <i>Hardox (Hardox 400/500)</i> Hardox (Hardox 400 / 500)	4–6	–	–	–	–	–	0,06	0,07	0,08	0,10	

Achtung:
Die obigen Empfehlungen gelten für Bohrer bis Bohrtiefe 3 x D:
Bitte reduzieren Sie den Vorschub bei 7 x D um den Faktor: 7 x D: 0,75

Attention:
Cutting datas refer to solid carbide drills 3 x D.
For using 7 x D please reduce the feed rate by following factor: 7 x D: 0,75

Attenzione:
I dati di taglio si riferiscono alle punte in metallo duro 3 x D.
Per usare le punte 7 x D prego ridurre l'avanzamento per il seguente fattore 0,75.

Empfohlenes Kühlmittel

Recommended coolant

Suggerimenti sul refrigerante

Werkstoff / Material / Materiale	Empfohlenes Kühlmittel / Recommended coolant / Suggerimenti sul refrigerante
Baustahl, Kohlenstoffstahl <i>Structural steels, Carbon steels</i> Acciaio da costruzione, Acciaio al carbonio	Emulsion (ca. 7–8%) <i>Emulsion (approx. 7–8%) / Emulsione (ca. 7 – 8%)</i>
Legierter Stahl, Stahlguss <i>Alloy steels, Cast steel</i> Acciaio legati, Acciaio stampati	Öl oder Emulsion (ca. 7–8%) <i>Emulsion (approx. 7–8%) or [oil] / Emulsione (ca. 7 – 8%) oppure [olio]</i>
Rostfreier Stahl, Federstahl <i>Stainless steel, Spring steel</i> Acciaio inossidabile, Acciaio per molle	Öl oder Emulsion (ca. 10–12%) <i>Oil or Emulsion (approx. 10–12%) / Olio oppure emulsione (ca. 10 – 12%)</i>

Vollhartmetall-Bohrer mit Kühlkanal DIN6537, TiAlN-beschichtet

Solid carbide drills with coolant DIN6537, TiAlN coated

Punta elicoidale in metallo duro con refrigerante DIN6537, rivestite TiAlN



Empfohlene Schnittwerte **10xD / 15xD / 20xD** / Cutting datas / Parametri di taglio

Werkstoff / Material / Materiale		V _c [m/min] V _c [m/rev] V _c [m/min]	Durchmesser / Diameter / Diametro [mm]			
			3~5	5~8	8~12	12~16
			f [mm/U]	f [mm/U]	f [mm/U]	f [mm/U]
Automatenstahl / Free cutting steel / Acciaio non legato	≤ 500 N/mm ²	90-110	0,14	0,200	0,275	0,350
	≥ 500 N/mm ²	75-100	0,10	0,150	0,200	0,260
Baustahl / Construction steel / Acciaio da costruzione	unlegiert / unalloyed / non legato ≤ 500 N/mm ²	90-110	0,14	0,200	0,275	0,350
	unlegiert / unalloyed / non legato ≥ 500 N/mm ²	75-100	0,10	0,150	0,200	0,260
	legiert / alloyed / legato	70-95	0,10	0,150	0,200	0,260
Federstahl / Spring steel / Acciaio per molle	gegült / annealed / ricotto (≤ 250 HB)	-	-	-	-	-
	naturhart / nature hard / trattato (250-350 HB)	-	-	-	-	-
	federhart / cold-hammered / forgiato (1200-1600 N/mm ²)	-	-	-	-	-
Einsatzstahl / Hardened steel / Acciaio trattato	≤ 150 HB	80-105	0,14	0,200	0,275	0,350
	150-200 HB	75-100	0,14	0,150	0,275	0,350
	≥ 200 HB	70-95	0,10	0,150	0,200	0,260
Nitrierstahl / Nitriding steel / Acciaio nitrurato	≤ 1000 N/mm ²	70-95	0,10	0,150	0,200	0,260
	≥ 1000 N/mm ²	70-95	0,10	0,150	0,200	0,260
Vergütungsstahl / Tempering steel / Acciaio da tempra	unlegiert / unalloyed / non legato ≤ 800 N/mm ²	75-95	0,14	0,200	0,275	0,350
	unlegiert / unalloyed / non legato 800-1000 N/mm ²	70-95	0,10	0,150	0,200	0,260
	legiert / alloyed / legato ≤ 800 N/mm ²	70-95	0,14	0,200	0,275	0,350
	legiert / alloyed / legato 800-1000 N/mm ²	70-95	0,10	0,150	0,200	0,260
	legiert / alloyed / legato 1000-1300 N/mm ²	55-75	0,10	0,150	0,200	0,260
	legiert / alloyed / legato 1300-1600 N/mm ²	-	-	-	-	-
Werkzeugstahl unlegiert / Unalloyed tool steel / Acciaio da utensili	allgemein / general / generico	55-75	0,10	0,150	0,200	0,260
Werkzeugstahl für Kaltarbeit / Tool steel for cold application / Acciaio da utensili per applicazioni a freddo	niedrig legiert / low alloy / debolmente legato ≤ 1000 N/mm ²	70-95	0,10	0,150	0,200	0,260
	niedrig legiert / low alloy / debolmente legato ≤ 1200 N/mm ²	55-75	0,10	0,150	0,200	0,260
	niedrig legiert / low alloy / debolmente legato ≤ 1500 N/mm ²	-	-	-	-	-
	hoch legiert-gegült / high alloy-annealed / altamente legato/ricotto ≤ 1000 N/mm ²	-	-	-	-	-
	hoch legiert-vergütet / high alloy-tempered / altamente legato/temprato ≤ 1300 N/mm ²	-	-	-	-	-
Werkzeugstahl für Warmarbeit / Tool steel for warm application / Acciaio da utensili per applicazioni a caldo	niedrig legiert / low alloy / debolmente legato ≤ 1200 N/mm ²	-	-	-	-	-
	niedrig legiert / low alloy / debolmente legato ≤ 1500 N/mm ²	-	-	-	-	-
	hoch legiert-gegült / high alloy-annealed / altamente legato/ricotto ≤ 1000 N/mm ²	55-75	0,10	0,150	0,200	0,260
	hoch legiert-vergütet / high alloy-tempered / altamente legato/temprato ≤ 1300 N/mm ²	-	-	-	-	-
	hoch legiert-vergütet / high alloy-tempered / altamente legato/temprato ≤ 1600 N/mm ²	-	-	-	-	-
Gehärteter Werkzeugstahl / Hardened tool steel / Acciaio da utensili temprato	55-70 HRC	-	-	-	-	-
Rostfreier Stahl / Stainless steel / Acciaio inossidabile	ferritisch / ferritic / feritico	70-75	0,08	0,120	0,150	0,200
	martensitisch / martensitic / martensitico	45-60	0,08	0,120	0,150	0,200
	austenitisch / austenitic / austenitico < 40%	50-65	0,08	0,120	0,150	0,200
	austenitisch / austenitic / austenitico > 40%	50-65	0,08	0,120	0,150	0,200
	geschwefelt / sulfated / solfatizzati	70-75	0,08	0,120	0,150	0,200
Hochwarmfeste Legierungen / High-temperature alloy / Leghe per alte temperature	Fe / Ni / Co-Legierungen / alloys / superleghe	-	-	-	-	-
Konventioneller Stahlguss / Conventional steel casting / Acciaio generici da fusione	unlegiert / unalloyed / non legato	75-100	0,14	0,200	0,275	0,350
	niedrig legiert / low alloy / debolmente legato	70-95	0,10	0,150	0,200	0,260
	hoch legiert / high alloy / altamente legato	55-75	0,10	0,150	0,200	0,260
Rostfreier Stahlguss / Stainless steel casting / Acciaio inossidabili da fusione	ferritisch/martensitisch / ferritic/martensitic / feritico/martensitico	45-65	0,08	0,120	0,15	0,200
	austenitisch / austenitic / austenitico	50-60	0,08	0,120	0,15	0,200
Grauguss (mit Lamellen-Graphit) / Cast iron (with lamella graphite) / Ghisa grigia	unlegiert / unalloyed / non legato ≤ 180 HB	85-105	0,23	0,335	0,425	0,520
	unlegiert / unalloyed / non legato ≥ 180 HB	75-100	0,23	0,335	0,425	0,520
	unlegiert / unalloyed / non legato	70-95	0,23	0,335	0,425	0,520
	hoch legiert / high alloy / altamente legato	65-75	0,08	0,120	0,150	0,200
Grauguss (mit Kugelgraphit) / Cast iron (with spheroidale graphite) / Ghisa sferoidale	unlegiert / unalloyed / non legato ≤ 180 HB	80-105	0,20	0,250	0,350	0,400
	unlegiert / unalloyed / non legato ≥ 180 HB	75-100	0,20	0,250	0,350	0,400
	unlegiert / unalloyed / non legato	55-75	0,11	0,125	0,150	0,175
	legiert / alloyed / legato	-	-	-	-	-
GTW (weißer Temperguss) / GTW (white malleable cast iron) / Ghisa malleabile	≤ 180 HB	80-105	0,20	0,250	0,350	0,400
	≥ 180 HB	75-100	0,20	0,250	0,350	0,400
GTS (schwarzer Temperguss) / GTS (black malleable cast iron) / Ghisa malleabile	≤ 180 HB	80-105	0,20	0,250	0,350	0,400
	≥ 180 HB	75-100	0,20	0,250	0,350	0,400
NE-Metalle / Non-ferrous metal / Metalli non ferrosi	Aluminium / Aluminium / Alluminio	-	-	-	-	-
	Magnesium / Magnesium / Magnesio	-	-	-	-	-
	Kupfer / Copper / Rame	-	-	-	-	-
	Messing / Brass (CuZn) / Ottone	-	-	-	-	-
	Bronze (CuSn) / Bronzo	-	-	-	-	-
Thermoplast / Duroplast / Termoplastiche / Duroplastiche		-	-	-	-	-
Faserverstärkter Kunststoff / Fibre-reinforced plastic / Plastiche rinforzate		-	-	-	-	-
Graphit / Graphite / Grafite		-	-	-	-	-



VHM-Spiralbohrer – Diamant beschichtet (mit Innenkühlung)

Solid carbide drills – diamond coated (with internal coolant)

Punte elicoidali in Metallo Duro – Rivestimento Diamante (con adduzione interna)



Empfohlene Schnittwerte **3xD / 5xD** / Cutting datas / Parametri di taglio

Werkstoff / Material / Materiale	Härte Hardness Durezza	V _c [m/min] V _c [m/rev] V _c [m/min]	Durchmesser / Diameter / Diametro [mm]									
			3 f [mm/U]	4 f [mm/U]	5 f [mm/U]	6 f [mm/U]	8 f [mm/U]	10 f [mm/U]	12 f [mm/U]	16 f [mm/U]	20 f [mm/U]	
Aluminium und Al-Legierungen Aluminium and AL alloys Alluminio e Leghe di Alluminio	< 400 N/mm ²	Öl/Emulsion/ Emulsione	260	0,160	0,200	0,250	0,315	0,315	0,400	0,500	0,630	0,630
Aluminium-Knetlegierungen Aluminium alloys – long chipping Leghe di Alluminio a truciolo lungo	< 450 N/mm ²	Öl/Emulsion/ Emulsione	260	0,160	0,200	0,250	0,315	0,315	0,400	0,500	0,630	0,630
Aluminium-Gusslegierungen < 10% Si Cast aluminium alloys < 10% Si Leghe di Alluminio da fusione < 10% Si	< 600 N/mm ²	Öl/Emulsion/ Emulsione	220	0,160	0,200	0,250	0,315	0,315	0,400	0,500	0,630	0,630
Aluminium-Gusslegierungen > 10% Si Cast aluminium alloys > 10% Si Leghe di Alluminio da fusione > 10% Si	< 600 N/mm ²	Öl/Emulsion/ Emulsione	180	0,160	0,200	0,250	0,315	0,315	0,400	0,500	0,630	0,630
Magnesium-Legierungen Magnesium alloys Leghe di Magnesio	< 450 N/mm ²	Luft/Air/Aria	260	0,160	0,200	0,200	0,250	0,315	0,400	0,400	0,500	0,630
Messing – kurzspanend Brass – short chipping Ottone – truciolo corto	< 600 N/mm ²	Öl/Emulsion/ Emulsione	270	0,160	0,200	0,200	0,250	0,315	0,400	0,400	0,500	0,630
Messing – langspanend Brass – long chipping Ottone – truciolo lungo	< 600 N/mm ²	Öl/Emulsion/ Emulsione	180	0,125	0,160	0,160	0,200	0,250	0,315	0,315	0,400	0,500

VHM-Spiralbohrer – Diamant beschichtet (mit Innenkühlung)

Solid carbide drills – diamond coated (with internal coolant)

Punte elicoidali in Metallo Duro – Rivestimento Diamante (con adduzione interna)



Empfohlene Schnittwerte **8xD** / Cutting datas / Parametri di taglio

Werkstoff / Material / Materiale	Härte Hardness Durezza	V _c [m/min] V _c [m/rev] V _c [m/min]	Durchmesser / Diameter / Diametro [mm]							
			3 f [mm/U]	4 f [mm/U]	5 f [mm/U]	6 f [mm/U]	8 f [mm/U]	10 f [mm/U]	12 f [mm/U]	
Aluminium und Al-Legierungen Aluminium and AL alloys Alluminio e Leghe di Alluminio	< 400 N/mm ²	Öl/Emulsion/ Emulsione	260	0,160	0,200	0,200	0,250	0,315	0,400	0,400
Aluminium-Knetlegierungen Aluminium alloys – long chipping Leghe di Alluminio a truciolo lungo	< 450 N/mm ²	Öl/Emulsion/ Emulsione	260	0,160	0,200	0,200	0,250	0,315	0,400	0,400
Aluminium-Gusslegierungen < 10% Si Cast aluminium alloys < 10% Si Leghe di Alluminio da fusione < 10% Si	< 600 N/mm ²	Öl/Emulsion/ Emulsione	220	0,160	0,200	0,200	0,250	0,315	0,400	0,400
Aluminium-Gusslegierungen > 10% Si Cast aluminium alloys > 10% Si Leghe di Alluminio da fusione > 10% Si	< 600 N/mm ²	Öl/Emulsion/ Emulsione	180	0,160	0,200	0,200	0,250	0,315	0,400	0,400
Magnesium-Legierungen Magnesium alloys Leghe di Magnesio	< 450 N/mm ²	Luft/Air/Aria	260	0,125	0,160	0,160	0,200	0,250	0,315	0,315
Messing – kurzspanend Brass – short chipping Ottone – truciolo corto	< 600 N/mm ²	Öl/Emulsion/ Emulsione	270	0,125	0,160	0,160	0,200	0,250	0,315	0,315
Messing – langspanend Brass – long chipping Ottone – truciolo lungo	< 600 N/mm ²	Öl/Emulsion/ Emulsione	180	0,100	0,125	0,125	0,160	0,200	0,250	0,250



Mindestdruck [bar]*Min. coolant pressure*
Pressione minima**Empfohlener Kühlmitteldruck / Recommended coolant pressure / Pressione suggerita del refrigerante**

Werkstoff / Material / Materiale	Durchmesser / Diameter / Diametro [mm]			
	5 [bar]	10 [bar]	15 [bar]	20 [bar]
Stahlbearbeitung <i>Steel drilling</i> Refrigerante nella foratura di Acciaio	22	15	9	5
Aluminiumbearbeitung <i>Aluminium drilling</i> Refrigerante nella foratura di Alluminio	25	20	15	10
Gussbearbeitung <i>Cast drilling</i> Refrigerante nella foratura di Ghisa	38	30	20	18

Mindestvolumen [L/min]*Min. coolant volume*
Portata Minima**Empfohlenes Kühlmittelvolumen / Recommended coolant volume / Portata suggerita del refrigerante**

Werkstoff / Material / Materiale	Durchmesser / Diameter / Diametro [mm]			
	5 [L/min]	10 [L/min]	15 [L/min]	20 [L/min]
Stahlbearbeitung <i>Steel drilling</i> Refrigerante nella foratura di Acciaio	3	6	7	9
Aluminiumbearbeitung <i>Aluminium drilling</i> Refrigerante nella foratura di Alluminio	4	6	9	10
Gussbearbeitung <i>Cast drilling</i> Refrigerante nella foratura di Ghisa	5	9	14	16

VHM-Spiralbohrer für gehärtete Stähle (ohne Innenkühlung)

Solid carbide drills for hardened steels (without internal coolant)

Punta elicoidale in metallo duro per Acciai Temprati senza adduzione interna



Empfohlene Schnittwerte 5xD / Cutting datas / Parametri di taglio

Material Härte Material hardness Durezza materiale	Vc [m/min]	Durchmesser / Diameter / Diametro [mm]								
		3	4	5	6	8	10	12	14	
50 ~ 55 HRC	14-22	[U/min]	1900	1430	1150	960	720	570	480	430
		[mm/U]	0,04 ~ 0,06	0,04 ~ 0,07	0,04 ~ 0,08	0,04 ~ 0,09	0,04 ~ 0,09	0,04 ~ 0,10	0,04 ~ 0,11	0,04 ~ 0,11
55 ~ 60 HRC	10-16	[U/min]	1330	1000	800	670	500	400	330	280
		[mm/U]	0,04 ~ 0,06	0,04 ~ 0,07	0,04 ~ 0,08	0,04 ~ 0,09	0,04 ~ 0,09	0,04 ~ 0,10	0,04 ~ 0,11	0,04 ~ 0,11
60 ~ 70 HRC	8-13	[U/min]	1250	850	750	630	480	380	320	270
		[mm/U]	0,04 ~ 0,06	0,04 ~ 0,07	0,04 ~ 0,08	0,04 ~ 0,09	0,04 ~ 0,09	0,04 ~ 0,10	0,04 ~ 0,11	0,04 ~ 0,11

Anwendungshinweise 10xD / 15xD / 20xD / Application notes / Applicazioni

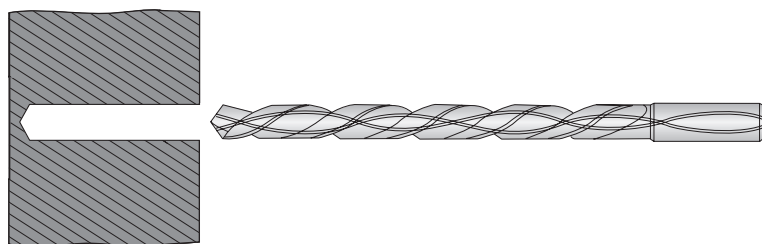
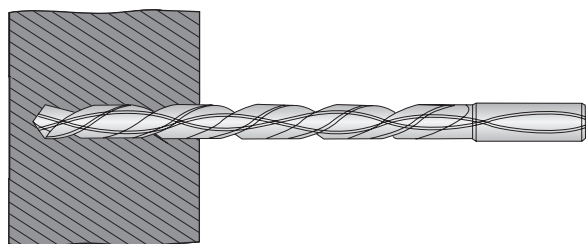
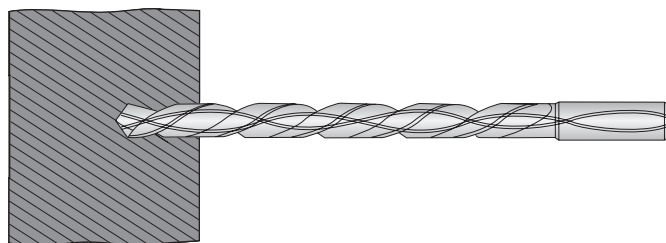
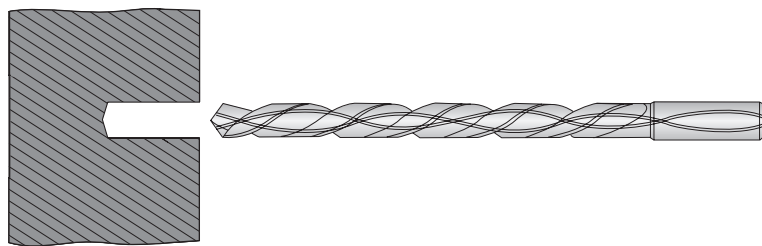

1. Pilotbohrung setzen zwischen 3 und 5xD tief im Nenndurchmesser (Tol. +0,1 mm). Verwenden Sie hierzu z. B. unsere VHM Bohrer in 3 oder 5xD (Toleranzklasse m7) welche sich hierfür hervorragend eignen.

Pre-Drilling should be done at the diameter +0.1 mm using 3 x D or 5 x D.

Pre-foro di diametro + 0,1mm con punte 3 x D o 5 x D.

2. Zur eigentlichen Bohrbearbeitung mit geringer Drehzahl in die Pilotbohrung einfahren (n = 300 U/min, Vf = 400 mm/min).

For main drilling, proceed with low RPM for pre-drilled length. (RPM 300 U/min, Feed 400 mm/min).

In entrata nel preforo procedere con basso numero di giri (n=300giri/min f=400 mm/min).

3. Kurz vor dem Grund der Pilotbohrung (ca. 0,5 bis 1 mm), den Vorschub auf null reduzieren und die Drehzahl auf empfohlene Werte erhöhen (siehe Schnittwerttabelle). Ebenso sollte nun die Kühlung aktiviert werden.

Just before the end of the pre-drilled hole, reduce feed to zero and increase the RPM according to the recommended cutting condition chart (see below).

A fine preforo fermare avanzamento ed aumentare il numero di giri a valore suggerito (vedi tabella sotto).

4. Nun mit der Bohrbearbeitung fortfahren, indem der Vorschub auf die empfohlenen Werte erhöht wird. Bohren möglichst in einem Zug ohne Spanbruchzyklus.

Then continue to drill the hole by increasing the feed without step drilling.

Procedere con la foratura aumentando l'avanzamento al valore prestabilito senza eseguire fermi avanzamento.

5. Nach Erreichen der Endbohrtiefe mit Drehzahl 300 U/min und Vorschubgeschwindigkeit 1000 mm/min aus der Bohrung herausfahren.

When retracting drill from pre-drilled hole after drilling, RPM should be reduced to 300 U/Min and feed should be 1000 mm/min.

In uscita, ridurre un numero di giri a 300 giri/min ed arretrate con f=1000 mm/min.

6. Bei Durchgangsbohrungen während des Austrittes den Arbeitsvorschub um ca. 50% reduzieren (f ca. 0,05 - 0,1 mm/U).

When drilling through-holes, feed-rate has to be reduced by 50% when breaking through (f = ca. 0.05 - 0.1 mm/U).

Nel caso di fori passanti, in uscita ridurre del 50% gli avanzamenti (f = ca.0.05 - 0.1 mm/U).

TiAlN (Titan Aluminium Nitrid)-Beschichtung

TiAlN (titanium aluminium nitride) coating

TiAlN (Nitruro di Titanio Alluminio)-Rivestimento

Durch den Einsatz von beschichteten Werkzeugen werden Ihre Produktionskosten reduziert, durch z. B.:

- Vermeidung von Maschinen-Ausfallzeiten wegen frühzeitigem Verschleiß des Bohrers
- höhere Bohrleistung, dadurch Reduzierung der Stückzeiten
- längere Standzeit
- verbesserte Oberflächengüte des Werkstücks

Der Zusatz von Aluminium zum Titan-Nitrid ermöglicht eine höhere Härte und einen außerordentlich guten Widerstand gegen Oxidation und hohe Temperaturen.

Geeignet zum Bohren unter extremen thermischen Bedingungen an der Hauptschneide bei kontinuierlichem Vorschub, Trockenbearbeitung oder Hochgeschwindigkeitsbohren.

The use of coated cutting tools reduce production costs.

For example:

- Avoidance of machine downtime due to premature tool wear
- higher cutting capabilities to reduce actual machining times
- highest tool life
- improvement of component surface quality

The addition of Aluminium to the Titanium Nitride produces an increase in hardness and an exceptional increase in resistance to oxidation at high temperatures.

TiAlN coating is applied to drilling with severe thermal stress on cutting edges when continuous non-step feed, dry cutting or high speed cutting.

L'utilizzo di utensili rivestiti riduce i costi di produzione.

Per esempio:

- si evitano i tempi di fermo macchina dovuti ad una prematura usura dell'inserto
- possibilità di lavorare con parametri di taglio più elevati in modo da diminuire il tempo ciclo
- vita utensile prolungata
- migliore finitura superficiale

L'aggiunta di allumina e nitruri di titanio produce un aumento della durezza e un eccezionale aumento della resistenza all'ossidazione alle alte temperature.

Il rivestimento TiAlN è utilizzato per forature senza soste con forti stress termici sui taglienti, lavorazione a secco o alte velocità di taglio.

Beschichtungseigenschaften

Properties of coating

Proprietà del rivestimento

Eigenschaften / Properties / Proprietà	TiAlN
Beschichtungsfarbe / Coating colour / Colore rivestimento	Violett - grau Violet - grey Violetto - Grigio
Härtegrad (Hv 0,05) / Hardness (Hv 0.05) / Durezza (Hv 0,05)	3000
Beschichtungsdicke (µm) / Coating thickness (µm) / Spessore rivestimento (µm)	1~5
Max. Arbeitstemperatur (°C) / Max. working temperature (°C) / Temperatura massima di lavoro (°C)	800
Reibungskoeffizient für Stahl (trocken) / Coefficient of friction against steel (dry) / Coefficiente di attrito con acciaio (a secco)	0,4

5

Informationen

- Vergleichstabellen
- Verschleiß und Abhilfe
- Anwendungshinweise

Informationen

- *Comparison tables*
- *Wear and its solution*
- *General recommendations*

Informationen

- Tavola comparativa
- Usura e soluzioni
- Suggerimenti tecnici

258 – 262

263 – 265

266 – 280

Werkstoff-Vergleichstabelle

Material – comparison table

Tavola comparativa dei materiali

ISO	Deutschland Germany Germania	Deutschland Germany Germania	Belgien Belgium Belgio	Frankreich France Francia	Großbritannien Great Britain Gran Bretagna	Italien Italy Italia
	W-Nr.	DIN	NBN	AFNOR	B.S.	UNI
Bau- und Konstruktionsstähle / Structural and constructional steels / Acciai da costruzione						
P	1.0401	C15	–	AF37C12	080A15	C15
	1.0402	C22	C25-1	AF42C20	055M15	C20
	1.0501	C35	C35-1	1C35	080A32	C35
	1.0503	C45	C45-1	1C45	060A47	C45
	1.0535	C55	C55-1	1C55	070M55	C55
	1.0601	C60	C60-1	1C60	060A62	C60
	1.0715	9SMn28	–	S250	230M07	CF9SMn28
	1.0718	9SMnPb28	–	S250Pb	–	CF9SMnPb28
	1.0722	10SPb20	–	10PbF2	–	CF10SPb20
	1.0726	10SPb2035S20	–	35MF6	212M36	–
	1.0736	9SMn36	–	S300	–	CF9SMn36
	1.0737	9SMnPb36	–	S300Pb	–	CF9SMnPb36
	1.1141	Ck15	C16-2	XC12	040A15	C15
	1.1157	40Mn4	–	35M5	150M36	–
	1.1158	C25E	C25-2	2C25	–	C25
	1-1167	36Mn5	–	35M5	150M36	–
	1.1170	28Mn6	28Mn6	20M5	–	C28Mn
	1.1183	Cf35	C36	XC38H1TS	080A35	C36
	1.1191	C45E	C45-2	2C45	080M46	C45
	1.1203	C55E	C55-2	2C55	060A57	C55
	1.1213	Cf53	C53	XC48H1TS	070M55	C53
	1.1221	C60E	C60-2	2C60	060A62	C60
	1.1274	Ck101	–	XC100	–	C100
	1.3401	X120Mn12	–	Z120M12	–	GX120Mn12
	1.3505	100Cr6	–	100C6	2S135	100Cr6
	1.5415	16Mo3	16Mo3	15D3	1503-243B	16Mo3
	1.5423	16Mo5	16Mo5	–	–	16Mo5KG
	1.5622	14Ni6	18Ni6	16N6	–	14Ni6KG
	1.5662	X8Ni9	10Ni36	9Ni490	1501-510	X10Ni9
	1.5680	X12Ni5	12Ni20	Z18N5	–	–
	1.5752	14NiCr14	13NiCr12	12NC15	655H13	–
	1.6511	36CrNiMo4	–	36CrNiMo4	817M37	38NiCrMo4
	1.6523	21NiCrMo2	–	20NCD2	805H20	20NiCrMo2
	1.6546	40NiCrMo2-2	40NiCrMo2	40NCD2	3111-Type7	40NiCrMo2
	1.6582	34CrNiMo6	35CrNiMo6	34CrNiMo8	816M40	35NiCrMo6KB
	1.6587	17CrNiMo6	17CrNiMo7	18NCD6	–	–
	1.6657	14NiCrMo13-4	14NiCrMo13	16NCD13	832H13	15NiCrM13
	1.7015	15Cr3	15Cr2	12C3	523M15	–
	1.7033	34Cr4	34Cr4	32C4	530A32	34Cr4
	1.7035	41Cr4	41Cr4	41Cr4	530A40	41Cr4
1.7045	42Cr4	–	42C4TS	530A40	41Cr4	
1.7131	16MnCr5	16MnCr5	16MC4	527M17	16MnCr5	
1.7176	55Cr3	55Cr3	55C3	525A58	55Cr3	
1.7218	25CrMo4	25CrMo4	25CD4	708A25	25CrMo4	
1.7220	34CrMo4	34CrMo4	34CrMo4	708A37	34CrMo4KB	
1.7223	41CrMo4	41CrMo4	42CD4TS	708M40	41CrMo4	
1.7225	42CrMo4	42CrMo4	42CD4	708A42	38CrMo4KB	
1.7262	15CrMo5	–	12CD4	–	–	
1.7335	13CrMo4-5	14CrMo45	15CD3,5	620-440	14CrMo3	
1.7361	32CrMo12	32CrMo12	30CD12	722M24	32CrMo12	
1.7380	10CrMo9-10	–	12CD9.10	1501-622/515	12CrMo910	
1.7715	14MoV6-3	13MoCrV6	–	1503-660-460	–	
1.8159	51CrV4	50CrV4	50CV4	735A51	50CrV4	
1.8509	41CrAlMo7	41CrAlMo7	40CAD6.12	905M39	41CrAlMo7	
1.8523	39CrMoV13-9	39CrMoV13	–	897M39	–	
Werkzeugstähle / Tool steels / Acciai da utensile						
P	1.1545	C105W1	–	C105E2U	–	C100KU
	1.1663	C125W	–	C120E3U	–	C120KU
	1.2067	102Cr6	–	100Cr6	–	–
	1.2080	X210Cr12	–	X200Cr12	BD3	X205Cr12KU
	1.2344	X40CrMoV5-1	–	X40CrMoV5	BH13	X40CrMoV511KU
	1.2363	X100CrMoV5-1	–	X100CrMoV5	BA2	X100CrMoV51KU
	1.2419	105WCr6	–	105WCr5	–	107WCr5KU
	1.2436	X210CrW12	–	X210CrW12-1	–	X215CrW121KU
	1.2542	45WCrV17	–	45WCrV8	BS1	45WCrV8KU
	1.2581	X30WCrV9-3	–	X30WCrV9	BH21	X30WCrV93KU
	1.2601	X165CrMoV12	–	–	–	X165CrMoV12KU
	1.2713	55NiCrMoV6	–	55NiCrMoV7	BH224/5	–
	1.2833	100V1	–	C105E2UV1	BW2	102V2KU
	1.3243	S6-5-2-5	–	Z85WDCV06-05-04-02	BM35	HS6-5-2-5
	1.3255	S18-1-2-5	–	HS18-1-1-5	BT4	HS18-1-1-5
	1.3343	S6-5-2	–	HS6-5-2	BM2	HS6-5-2
	1.3348	S2-9-2	–	HS2-9-2	–	HS2-9-2
	1.3355	S18-0-1	–	HS18-0-1	BT1	HS18-0-1

Werkstoff-Vergleichstabelle

Material – comparison table

Tavola comparativa dei materiali

ISO	Japan Japan Giappone JIS	Schweden Sweden Svezia SS	Russland Russia Russia GOST	Spanien Spain Spagna UNE	USA USA USA AISI/SAE/ASTM
Bau- und Konstruktionsstähle / Structural and constructional steels / Acciai da costruzione					
P	S15C	1350	–	F.111	M1015
	S20C	1450	20	1C22	M1020
	S35C	1572	35	F.113	1035
	S45C	1672	45	F.114	1045
	S55C	1655	55	–	1055
	S58C	–	60	–	1060
	SUM22	1912	–	F.2111-11SMn28	1213
	SUM22L	1914	–	F.2112-11SMnPb28	12L13
	–	–	–	F.2122-10SPb20	11L08
	–	1957	–	F.210.G	1140
	SUM25	–	–	F.2113-12SMn35	1215
	–	1926	–	F.2114-12SMnPb35	12L14
	S15	1370	15	F.1110-C15k	1015
	–	–	40G	–	1035
	S25C	–	25	F.1120-C25k	1025
	SMn438	2120	35G2	F.1203-36Mn6	1335
	SCMn1	–	30G	28Mn6	1330
	S35C	1572	35	–	1035
	S45C	1672	45	F.1140-C45k	1045
	S55C	1655	55	F.1150-C55k	1055
	S50C	1674	50	–	1050
	S58C	1665	60	–	1060
	SUP4	1870	–	–	1095
	SCMnH1	2183	110G13L	F.8251-AM-X120Mn12	A128
	SUJ2	2258	SchCh15	F.1310-100Cr6	52100
	–	2912	–	F.2601-16Mo3	A204Gr.A
	SB450M	–	–	F.2602-16Mo5	4520
	–	–	–	F.2641-15Ni6	A350-LF5
	SL9N53	–	–	F.2645-X8Ni09	A353
	–	–	–	–	2515
	SNC815	–	–	–	3310
	–	–	40ChN2MA	F.1280-35NiCrMo4	4340
	SNCM220	2506	–	F.1522-20NiCrMo2	8620
	SNCM240	–	38ChGNM	F.1204-40NiCrMo2	8740
	SNCM447	2541	38Ch2N2MA	F.1272-40NiCrMo7	4337
	–	–	–	F.1560-14NiCrMo13	–
	–	–	–	F.1560-14NiCrMo13	9310
	SCr415	–	15Ch	–	5015
	SCr430	–	35Ch	F.8221-35Cr4	5132
	SCr440	–	40Ch	F.1211-41Cr4DF	5140
	SCr440	2245	40Ch	F.1202-42Cr4	5140
	–	2173	18ChG	F.1516-16MnCr5	5115
	SUP9	2253	50ChGA	F.1431-55Cr3	5155
	SCM420	2225	20ChM	F.8372-AM26CrMo4	4130
	SCM432	2234	AS38ChGM	F.8331-AM34CrMo4	4135
	SCM440	2244	40ChFA	F.8332-AM42CrMo4	4140
	SCM440	2244	–	F.8332-AM42CrMo4	4140
SCM415	–	–	F.1551-12CrMo4	–	
SFVA12	2216	12ChM	F.2613-14CrMo45	A182-F11	
–	2240	–	F.124.A	–	
SFVAF22A	2218	12Ch8	TU.H	A182F22	
–	–	–	F.2621-13MoCrV6	–	
SUP10	2230	50ChGFA	F.1430-51CrV4	6145	
SACM645	2940	38ChMJuA	F.1740-41CrAlMo7	A355Cl.A	
–	–	–	–	–	
Werkzeugstähle / Tool steels / Acciai da utensile					
P	SK3	1880	U10A-1	F.515	W110
	SK2	–	U13-1	F.5123-C120	W112
	SUJ2	–	Ch	F.5230-100Cr6	L1
	SKD1	–	Ch12	F.5212-X210Cr12	D3
	SKD61	2242	4Ch5MF1S	F.5318-X40CrMoV5	H13
	SKD12	2260	–	F.5227-X100CrMoV5	A2
	SKD2	2140	–	F.5233-105WCr5	–
	–	2312	–	F.5213-X210CrW12	–
	–	2710	5ChW2SF	F.5241-45WCrSi8	S1
	SKD5	–	3Ch2W8F	F.5323-X30WCrV9	H21
	–	–	–	F.5211-X160CrMoV12	–
	SKT4	–	5ChNM	F.520S	L6
	SKS43	–	–	–	W210
	SKH55	2733	R6M5K5	F.5613-6-5-2-5	–
	SKH3	–	–	F.5530-18-1-1-5	T4
	SKH51	2722	R6M5	F.5603-6-5-2	M2
	–	2782	–	F.5607-2-9-2	M7
	SKH2	–	R18	F.5520-18-0-1	T1

Werkstoff-Vergleichstabelle

Material – comparison table

Tavola comparativa dei materiali

ISO	Deutschland Germany Germania W-Nr.	Deutschland Germany Germania DIN	Belgien Belgium Belgio NBN	Frankreich France Francia AFNOR	Großbritannien Great Britain Gran Bretagna B.S.	Italien Italy Italia UNI
Rost-, säure- und hitzebeständige Stähle / Stainless and heat resisting steels / Acciai inossidabili e refrattari						
P	1.4000	X6Cr13	–	Z8C12	403S17	X6Cr13
	1.4001	X7Cr14	–	Z8C13FF	403S17	X6Cr13
	1.4006	X12Cr13	–	Z10C13	410S21	X12Cr13
	1.4016	X6Cr17	–	Z8C17	430S17	X8Cr17
	1.4027	GX20Cr14	–	Z20C13M	ANC1B	–
	1.4034	X46Cr13	–	Z44C14	–	X40Cr14
	1.4057	X20CrNi172	–	Z15CN16-02	431S29	X16CrNi16
	1.4104	X12CrMoS17	–	Z13CF17	–	X10CrS17
	1.4113	X6CrMo17-1	–	–	434S17	X8CrMo17
	1.4313	X4CrNi134	–	Z4CND13.4M	425C11	GX6CrNi1304
	1.4408	GX5CrNiMo19-11	–	–	316C16	–
	1.4718	X45CrSi9-3	–	Z45CS9	401S45	X45CrSi8
	1.4724	X10CrAl13	–	Z13C13	–	X10CrAl12
	1.4742	X10CrAl18	–	Z12CAS18	–	–
	1.4747	X80CrNiSi20	–	Z80CNS20-02	443S65	X80CrSiNi20
	1.4762	X10CrAl24	–	Z12CAS25	–	–
	1.4301	X5CrNi1810	–	Z4Cn19-10FF	304S11	X5CrNi1810
	1.4305	X10CrNiSi189	–	Z8CNF19-09	303S22	X10CrNiSi1809
	1.4306	X2CrNi19-11	–	Z1CN18-12	304S11	X3CrNi1811
	1.4308	GX5CrNi19-10	–	Z6CN18.10M	304C15	–
1.4310	X12CrNi177	–	Z11CN17-08	301S21	X12CrNi1707	
1.4311	X2CrNi18-10	–	Z3CN18-07Az	304S61	X2CrNi1811	
1.4401	X5CrNiMo17122	–	Z3CND17-11-01	316S13	X5CrNiMo1712	
1.4429	X2CrNiMo17-13-3	–	Z3CND17-12Az	316S63	X2CrNiMo1713	
1.4435	X2CrNiMo18-14-3	–	Z3CND17-12-03	316S11	X2CrNiMo1713	
1.4438	X2CrNiMo18164	–	Z2CND19-15-04	317S12	X2CrNiMo1816	
1.4460	X4CrNiMoN2752	–	Z5CND27-05Az	–	–	
1.4541	X6CrNiTi18-10	–	Z6CNT18-10	321S31	X6CrNiTi1811	
1.4550	X6CrNiNb18-10	–	Z6CnNb18-10	347S20	X6CrNiNb1811	
1.4571	X6CrNiMoTi17-12-2	–	Z6CNDT17-12	320S18	X6CrNiMoTi1712	
1.4581	GX5CrNiMoNb1810	–	Z4CNDNb18.12M	318C17	GX6CrNiMoNb2011	
1.4583	X10CrNiMoNb18-12	–	–	–	X6CrNiMoNb1713	
1.4828	X15CrNiSi20-12	–	Z9CN24-13	309S24	X16CrNi2314	
1.4845	X12CrNi25-21	–	Z8CN25-20	310S16	X6CrNi2521	
1.4864	X12NiCrSi36-16	–	Z20NCS33-16	NA17	–	
1.4865	GX40NiCrSi38-18	–	–	330C11	GX50NiCr3919	
1.4871	X53CrMnNiN21-9	–	Z53CMNS21-09Az	349S54	X53CrMnNiN219	
1.4878	X12CrNiTi18-9	–	Z6CNT18-10	321S51	–	
Gusswerkstoffe / Cast iron / Ghisa						
K	–	GG10	–	Ft10D	–	G10
	–	GG15	–	Ft15D	Grade150	G15
	–	GG20	–	Ft20D	Grade220	G20
	–	GG25	–	Ft15D	Grade260	G25
	–	GG30	–	Ft30D	Grade300	G30
	–	GG35	–	Ft35D	Grade350	G35
	–	GG40	–	Ft40D	Grade400	–
	–	GGG40	–	FGS400-12	420/12	GS400-12
	–	GGG40.3	–	FGS370-17	370/17	GS042/15
	–	GGG50	–	FGS500-7	500/7	GS500/7
	–	GGG60	–	FGS600-3	600/3	GS600/3
	–	GGG70	–	FGS700-2	700/2	GS700/2
	–	GGGNiMn137	–	S-NM137	S-NiMn137	–
	–	GGGNiCr202	–	S-NC202	S-NiCr202	–

Werkstoff-Vergleichstabelle

Material – comparison table

Tavola comparativa dei materiali

ISO	Japan Japan Giappone JIS	Schweden Sweden Svezia SS	Russland Russia Russia GOST	Spanien Spain Spagna UNE	USA USA USA AISI/SAE/ASTM
Rost-, säure- und hitzebeständige Stähle / Stainless and heat resisting steels / Acciai inossidabili e refrattari					
P	SUS403	2301	08Ch13	F.3110-X6Cr13	403
	SUS410S	2301	08Ch13	F.8401-AM-X12Cr13	410S
	SUS410	2302	12Ch13	F.3401-X10Cr13	410
	SUS430	2320	12Ch17	F.3113-X6Cr17	430
	SCS2	-	20Ch13L	-	-
	-	-	40Ch13	F.3405-X45Cr13	-
	SUS431	2321	20Ch17N2	F.3427-X19CrNi172	431
	SUS430F	2383	-	F.3117-X10CrS17	430F
	SUS434	-	-	F.3116-X6CrMo171	434
	SCS5	2384	-	-	-
	SCS14	-	07Ch18N10G2S2M2L	F.8414-AM-X7CrNiMo2010	CF-8M
	SUH1	-	40Ch9S2	F.3220-X4SCrSi09-03	HNv3
	-	-	10Ch13SJü	F.3152-X10CrAl13	-
	SUH21	-	15Ch18SJü	F.3153-X10CrAl18	-
SUH4	-	-	F.3222-X80CrSiNi20-02	HNv6	
-	-	-	F.3154-X10CrAl24	-	
M	SUS304	2332	08Ch18N10	F.3504-X5CrNi1810	304
	SUS303	2346	-	F.3508-X10CrNiS18-09	303
	SCS19	2352	03Ch18N11	F.3503-X2CrNi1810	304L
	SCS13	2333	07Ch18N9L	-	CF-8
	SUS301	2331	-	F.3517-X12CrNi177	301
	SUS304LN	2371	-	F.3541-X2CrNiN1810	304LN
	SUS316	2347	-	F.3534-X5CrNiMo17122	316
	-	2375	-	F.3543-X2CrNiMoN17313	316LN
	SUS316L	2353	03Ch17N14M3	F.3533-X2CrNiMo17132	316L
	SUS317L	2367	-	F.3539-X2CrNiMo18164	317L
	SUS329J1	2324	-	F.3309-X8CrNiMo27-05	329
	SUS321	2337	06Ch18N10T	F.3523-X6CrNiTi1810	321
	SUS347	2338	08Ch18N12B	F.3524-X6CrNiNb1810	347
	SUS316Ti	2353	10Ch17N13M2T	F.3535-X6CrNiMoTi17122	316Ti
	SCS22	-	-	-	-
	-	-	-	-	318
	SUH309	-	20Ch20N14S2	F.3312-X15CrNiSi20-12	309
	SUH310	2361	20Ch23N18	-	310S
	SUH330	-	-	F.3313-X12CrNiSi36-16	330
	SCH15	-	-	-	-
	SUH35	-	55Ch20G9AN4	F.3217-X53CrMnNiN21-09	EV8
	SUS321	-	-	-	321
Gusswerkstoffe / Cast iron / Ghisa					
K	FC10	0110-00	Sc10	FG10	A48-20B
	FC15	0115-00	Sc15	FG15	A48-25B
	FC20	0120-00	Sc20	FG20	A48-30B
	FC25	0125-00	Sc25	FG25	A48-40B
	FC30	0130-00	Sc30	FG30	A48-45B
	FC35	0135-00	Sc35	FG35	A48-50B
	-	0140-00	Sc40	Ft40D	A48-60B
	FCD40	0717-02	VC42-12	-	60-40-18
	-	0717-15	VC42-12	-	-
	FCD50	0727-02	VC50-2	-	65-45-12
	FCD60	0732-03	VC60-2	-	80-55-06
	FCD70	0737-01	VC70-2	-	100-70-03
	-	-	-	-	-
	-	-	-	-	A439TypeD-2

Härtevergleich

Hardness – comparison table

Comparazione delle durezze

Zugfestigkeit Tensile strength Durezza N/mm ²	Vickers HV	Brinell HB	Rockwell HRC	Brinell „SH“
700		200	–	28
740		210	–	29
770		220	–	30
810		230	19,2	31
840		240	21,2	33
880		250	23,0	34
910		260	24,7	35
950		270	26,1	36
980		280	27,6	37
1020		290	29,0	39
1050		300	30,0	40
1090		310	31,5	41
1120		320	32,9	42
1150		330	33,8	43
1190		340	34,9	44
1230		350	36,0	45
1260	360		37,0	46
1300	370	359	38,0	47
1330	380	368	38,9	48
1370	390	373	39,8	49
1400	400	385	40,7	50
1440	410	393	41,5	51
1470	420	400	42,3	52
1510	430	407	43,2	53
1540	440	416	44,0	54
1580	450	423	44,8	55
1610	460	429	45,5	56
1650	470	435	46,3	57
1680	480	441	47,0	58
1720	490	450	47,7	59
1750	500	457	48,3	60
1790	510	465	49,0	61
1820	520	474	49,6	62
1860	530	482	50,3	63
1890	540	489	50,9	64
1930	550	496	51,5	65
1960	560	503	52,1	66
2000	570	511	52,7	67
2030	580	520	53,3	68
2070	590	527	53,8	69
2100	600	533	54,4	70
2140	610	533	54,9	71
2170	620	543	55,4	72
2210	630	549	55,9	73
2240	640	555	56,4	74
2280	650	561	56,9	75
2310	660	568	57,4	75
2350	670	574	57,9	76
2380	680	581	58,7	77
2410	690	588	58,9	78
2450	700	595	59,3	79
2480	710	602	59,8	80
2520	720	609	60,2	81
2550	730	616	60,7	82
2590	740	622	61,1	83
2630	750	627	61,5	83
2660	760	633	61,9	84
2700	770	639	62,3	85
2730	780	644	62,7	86
2770	790	650	63,1	86
2800	800	656	63,5	87
2840	810	661	63,9	87
2870	820	666	64,3	88
2910	830	670	64,6	89
2940	840	677	65,0	89
2980	850	682	65,3	90
3010	860	–	65,7	90
3050	870	–	66,0	91
3080	880	–	66,3	91
3120	890	–	66,6	92
3150	900	–	66,9	92
3190	910	–	67,2	–
3220	920	–	67,5	–
3260	930	–	67,7	–
3290	940	–	68,0	–

Freiflächenverschleiß / Flank wear / Usura sul fianco

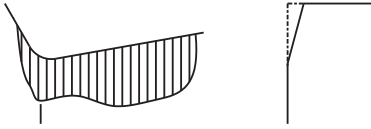

Abrasive Verschleißform, bei der eine mechanische Belastung die Entstehung einer ebenen Fläche an der Freifläche der Schneidkante bewirkt. Zu großer Freiflächenverschleiß führt zu schlechter Oberflächengüte, Ungenauigkeit und zunehmender Reibung.

Abhilfe:

- Schnittgeschwindigkeit verringern
- Verschleißfestere Sorte wählen

Abrasive wear, resulting from mechanical stresses – can be seen as a flat on the clearance of the cutting edge. Excessive flank wear result in bad surface finish, inaccuracy and increasing friction.

Solution:

- reduce cutting speed
- choose more wear resistant grade

Usura abrasiva, dovuta a stress meccanici, che appare come in piano sullo spigolo tagliente. Una usura eccessiva del fianco porta a una cattiva finitura superficiale, ridotta precisione e crescente frizione.

Soluzioni:

- ridurre la velocità di taglio
- scegliere un grado con migliore resistenza all'usura

Kerbverschleiß / Wear by intonation / Usura ad intaglio



Kerbverschleiß an der Hauptschneide entsteht dort, wo diese direkt mit dem Werkstück zusammentrifft. Die Ursache ist auf Hartpartikel des Werkstückmaterials zurückzuführen. Großer Kerbverschleiß beeinflusst die Spanbildung und kann zum Bruch der Wendeschneidplatte führen.

Abhilfe:

- Vorschub reduzieren
- Verschleißfestere Sorte wählen

Wear by intonation on the main cutting edge can be seen where the cutting edge and workpiece has its contact. The main reason are hard particles in the workpiece material. Excessive wear by intonation influences chip formation and can also lead to insert breakage.

Solution:

- reduce feed rate
- choose more wear resistant grade

L'usura per scheggiatura del tagliente principale è dove il tagliente ed il pezzo si toccano. La ragione principale è la presenza di componenti duri all'interno del pezzo da lavorare. Un usura eccessiva per scheggiatura influenza la formazione di truciolo che può portare alla rottura dell'inserto.

Soluzioni:

- ridurre l'avanzamento
- scegliere un grado con migliore resistenza all'usura

Kolkverschleiß / Crater wear / Usura a cratere



Verschleiß auf der Spanfläche hervorgerufen durch Diffusion und Abrasion. Der Kolkverschleiß entsteht durch das Abtragen von Schneidstoff (Schleifvorgang) und Diffusion an der heißesten Stelle der Schneide (Kontakt Span-Schneidstoff). Großer Kolkverschleiß verändert die Geometrie der Schneide, kann die Spanbildung stören und die Schneide schwächen.

Abhilfe:

- Schnittgeschwindigkeit verringern
- Vorschub senken
- Beschichtete Hartmetallsorte einsetzen
- Positive Wendeschneidplatten-geometrie wählen

Wear on the rake angle caused by diffusion and abrasion. Crater wear results from the contact chip / cutting material and diffusion at the hot part of the cutting edge. Excessive crater wear changes the geometry, can disturb chip-formation and can weaken the cutting edge.

Solution:

- reduce cutting speed
- reduce feed rate
- use coated carbide grades
- choose positive cutting geometry

L'usura della superficie di taglio causata da diffusione e abrasione. L'usura a cratere risulta dal contatto fra il truciolo del materiale lavorato e la diffusione sulla parte calda del tagliente. Un'eccessiva usura modifica la geometria, può disturbare la formazione di truciolo ed indebolire il tagliente.

Soluzioni:

- ridurre la velocità di taglio
- ridurre l'avanzamento
- usare gradi di carburo rivestiti

Plastische Deformation / Plastic deformation / Deformazione plastica



Verschleiß infolge hoher Temperaturen und Druck an der Schneidkante verursacht durch hohe Schnittgeschwindigkeiten und Vorschübe sowie harte Werkstückmaterialien. Plastische Deformation führt zu schlechter Spankontrolle und Oberflächengüte und unter Umständen zum Bruch der Wendeschneidplatte.

Abhilfe:

- Schnittgeschwindigkeit verringern
- Vorschub senken
- Verschleißfestere Hartmetallsorte wählen

Wear caused by high temperature and stress on the cutting edge - mainly because of high cutting speeds and feed rates and hard workpiece materials. Plastic deformation leads to bad chip formation and surface quality and in some cases to insert breakage.

Solution:

- reduce cutting speed
- reduce feed rate
- use more wear resistant carbide grades

Usura causata dall'alta temperatura d'esercizio combinata ad una pressione sul tagliente, principalmente dovuta ad elevate velocità di taglio e avanzamenti insieme alla durezza del materiale da lavorare. La deformazione plastica causa una cattiva formazione di truciolo e in alcuni casi la rottura dell'inserto.

Soluzioni:

- ridurre la velocità di taglio
- ridurre l'avanzamento
- scegliere un grado con migliore resistenza all'usura

Aufbauschneide / Build-up edge / Tagliente di riporto

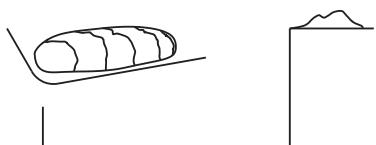

Aufbauschneide auf der Spanfläche durch Verschweißen von Werkstückmaterial mit dem Schneidstoff. Neben der Geometrieänderung kann es beim Abreißen der Aufbauschneide zu Kantenausbrüchen kommen. Die Bildung einer Aufbauschneide verursacht eine schlechte Oberflächengüte und kann bis hin zum Bruch der Wendeschneidplatte führen.

Abhilfe:

- Schnittgeschwindigkeit erhöhen
- Positive Schneidengeometrie wählen
- Einsatz von beschichteten Hartmetallen oder Cermets
- Kühlschmiermittel verwenden

Welding of workpiece material on the cutting material. Cutting geometry will change and build-up edge will generally lead to cutting edge outbreaks. Build-up edges lead to bad surface finish and breakage of the insert.

Solution:

- increase cutting speed
- choose positive cutting geometry
- use coated carbide grades or Cermets
- use lubricant

Le increspature del materiale sull'inserto. La geometria di taglio è cambiata e può portare a fratture del tagliente. Queste increspature portano ad una cattiva finitura superficiale ed alla rottura dell'inserto.

Soluzioni:

- aumentare la velocità di taglio
- usare un grado di carburo rivestito o Cermet
- usare lubrificante

Kantenausbrüche / Cutting edge outbreaks / Fratture del tagliente



Statt einer gleichmäßigen Abnutzung der Schneidkante brechen hier kleine Teile der Schneide aus. Die Hauptursache hierfür liegt im unterbrochenen Schnitt. Kantenausbrüche führen zu einer schlechten Oberflächengüte und starkem Freiflächenverschleiß.

Abhilfe:

- Vorschub zu Beginn der Bearbeitung verringern
- Hartmetallsorte mit höherer Zähigkeit wählen
- Wendeschneidplatte mit stabilerer Schneidengeometrie wählen

Instead of having uniform wear, small parts of the cutting edge break away. The main reason is interrupted cutting. Cutting edge outbreaks lead to bad surface finish and excessive flank wear.

Solution:

- reduce feed rate when starting machining
- choose carbide grade with higher toughness
- use indexable insert with stronger cutting edge

Invece di avere una usura uniforme, piccole parti del tagliente si danneggiano. La ragione principale è il taglio interrotto. La frattura del tagliente porta una cattiva finitura superficiale ed una eccessiva usura del fianco.

Soluzioni:

- ridurre l'avanzamento quando si inizia la lavorazione
- scegliere un grado con maggiore tenacità
- scegliere un inserto con un tagliente più robusto

Plattenbruch / Insert breakage / Rottura dell'inserto



Der Bruch der Wendeschneidplatte bringt häufig eine Beschädigung von Werkzeug und Werkstück mit sich. Die Ursachen sind oft zu hoher Verschleiß oder Belastung der Schneide, können aber auch von Maschine und Werkstück abhängig sein.

- Abhilfe:**
- Zähere Sorte wählen
 - Vorschub und/oder Schnitttiefe verringern
 - Wendeschneidplatte mit größerer Stabilität und Eckenradien wählen

Insert breakage will mainly damage the tool and work piece. The reasons are mainly excessive wear or stress on the cutting edge but can also be the machine or the workpiece.

- Solution:**
- choose tougher grade
 - reduce feed rate and/or depth of cut
 - choose indexable insert with higher stability or larger corner radius, if possible single sided indexable inserts

Una rottura dell'inserto significa in generale deterioramento dell'utensile e del pezzo. Le cause sono spesso Una usura o una pressione eccessiva sul tagliente. Può anche dipendere dalla lavorazione del pezzo.

- Soluzioni:**
- scegliere un grado più tenace
 - ridurre l'avanzamento o la profondità di taglio
 - scegliere un inserto più stabile o con un angolo di raggio più grande

Kammrisse / Thermal cracks / Fessure



Bildung von Rissen senkrecht zur Schneidkante, hervorgerufen durch Temperaturwechsel im unterbrochenen Schnitt. Kammrisse führen zu schlechter Oberflächenqualität und Kantenausbrüchen.

- Abhilfe:**
- Einsatz einer Sorte mit hoher Zähigkeit
 - Kontinuierliche Kühlschmiermittelzuführung

Cracks vertical to the cutting edge, resulting from changing temperature during interrupted cutting.

- Solution:**
- use a carbide grade with higher toughness
 - pay attention to the use of lubricants – either in good quantity or non at all

Formazione di fessure perpendicolari, risultato dello shock termico durante il taglio interrotto. Le fessure originano una finitura superficiale mediocre e fratture del tagliente.

- Soluzioni:**
- usare un grado con maggiore tenacità
 - refrigerante di continuo

Verwendung von Bohrern / Use of drills / Uso delle punte elicoidali in metallo duro integrale

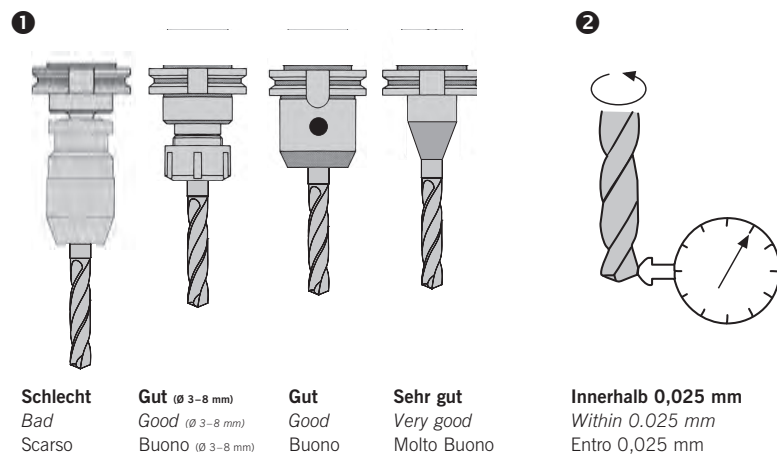

Auf sichere Spannung des Werkzeugs achten!
Ensure secure fastening of the components!
Assicurarsi del corretto montaggio dell'utensile!

1
Richtiges Spannen!
Chucking correctly!
Serrare correttamente l'utensile!

2
Radialer Rundlauf an der Schneidkante darf 0,025 mm nicht überschreiten.
Radial run out at cutting lip must not exceed 0.025 mm.
Verificare che il Run out radiale misurato sui lati tagliente non superiore a 0,025 mm.

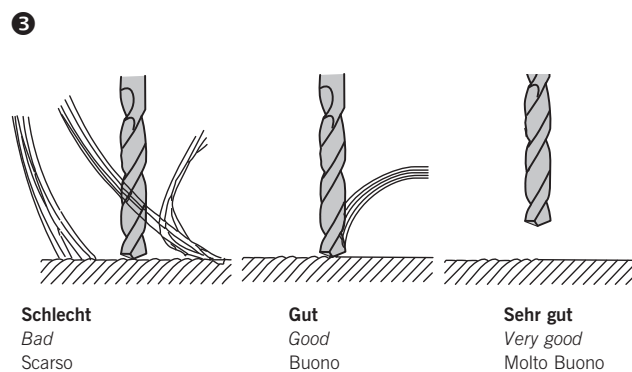

3
Ausreichende Kühlmittelzufuhr am Bohrloch.
Supply coolant enough to the entrance of hole.
Indirizzare il refrigerante in modo corretto.

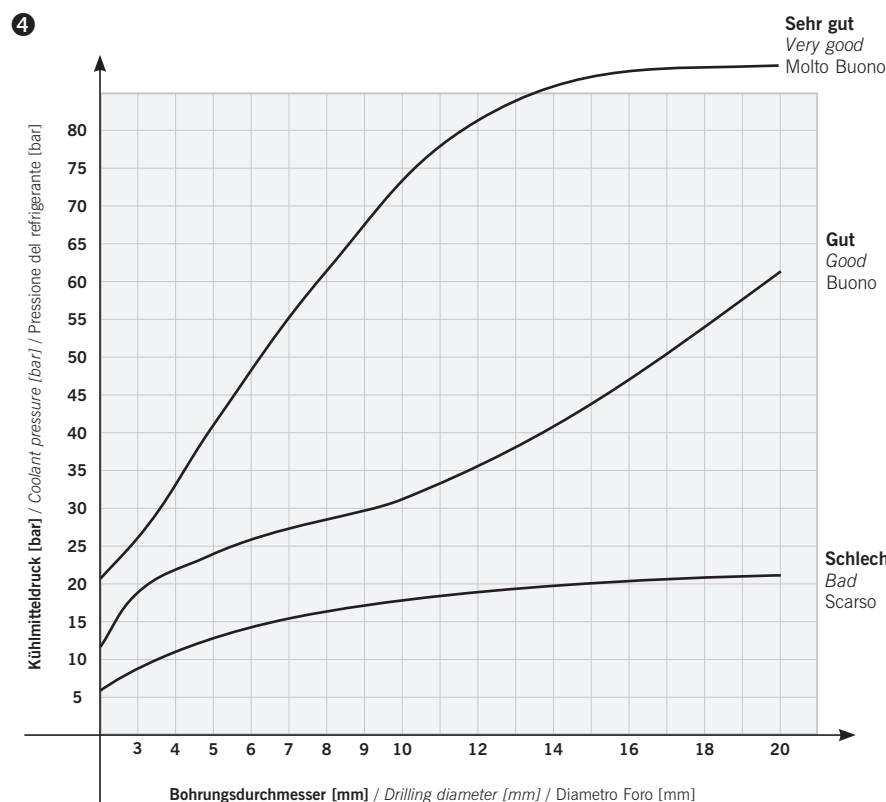

4
Beim Verwenden von Bohrern mit Kühlkanal wird Hochdruckkühlung benötigt.
When using drill with Coolant need high pressure coolant.
Con l'utilizzo delle punte in metallo duro integrale utilizzare refrigerante con alta pressione.

Definition / Cutting portion / Terminologie

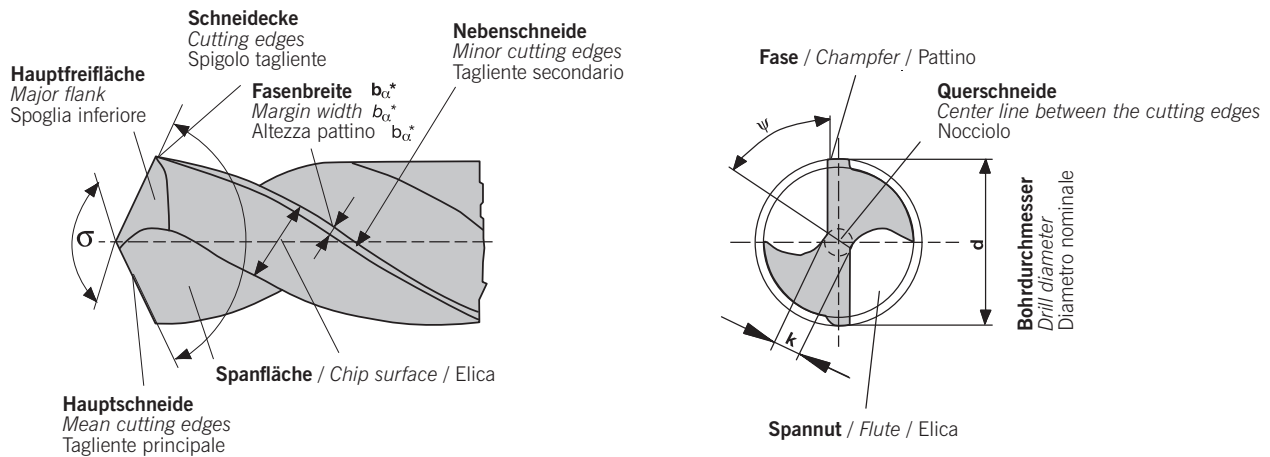

σ = Spitzenwinkel (Sigma)
 ψ = Querschneidenwinkel (Psi)

* Die Fasenbreite b_{α} ist – zerspanungs-technisch gesehen – als Fasenbreite der Nebenfrefläche und mit b_{fan} zu bezeichnen (siehe DIN 6581).

σ = Point angle (sigma)
 ψ = Chisel edge angle (psi)

* In the context of cutting technology, land width b_{α} is the body clearance land width which is to be by b_{fan} (see DIN 6581).

σ = Angolo di punta (Sigma)
 ψ = Angolo tagliente centrale (Psi)

* Nel contesto delle tecnologie di foratura, la fase cilindrica b_{α} è la spoglia inferiore di taglio da cui parte b_{fan} (voir DIN 6581).

Winkel an den Schneiden / Angle at the cutting edges / Angoli di taglio

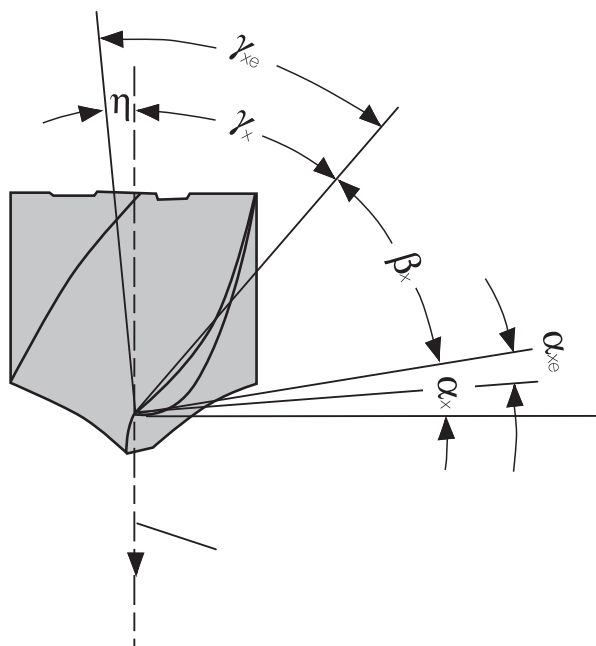

Freiwinkel α , Keilwinkel β und Spanwinkel γ werden in der Keilmessebene gemessen. Einzelheiten siehe DIN 6581, (Begriffe der Zerspanungstechnik, Geometrie am Schneidkeil des Werkzeuges).

Clearance angle α , wedge angle β and rake angle γ are measured in the tool orthogonal plane. For details, see DIN 6581, definitions of metal-cutting technology; geometry at the tool edge.

Als betrachteter Schneidenpunkt ist die Schneidenebene gewählt.

The corner has been adopted as the observed edge point.

L'angolo della cuspide è considerato il punto di osservazione di questa vista.

α_x = Seitenfreiwinkel (Alpha)
Side clearance angle (alpha)
Angolo di spoglia inferiore (Alpha)

α_{xe} = Wirk-Seitenfreiwinkel
Effective side clearance angle
Angolo di spoglia inferiore effettivo

β_x = Seitenkeilwinkel (Beta)
Side wedge angle (beta)
Angolo di taglio (beta)

γ_x = Seitenspanwinkel (Gamma)
Front rake angle (gamma)
Angolo di spoglia superiore (Gamma)

γ_{xe} = Wirk-Seitenspanwinkel
Working front rake angle
Angolo di spoglia di lavoro

η = Wirkrichtungswinkel (Eta)
Resultant cutting speed angle (eta)
Angolo risultante di velocità di taglio (Eta)

Gli angoli di spoglia inferiore e angoli di taglio sono misurati sul piano ortogonale dell' utensile. Per dettagli vedi norme DIN 6581, definizioni della tecnologia della lavorazioni dei metalli; lato tagliente.

Kerndicke K / *Web thickness K* / Spessore del nocciolo K

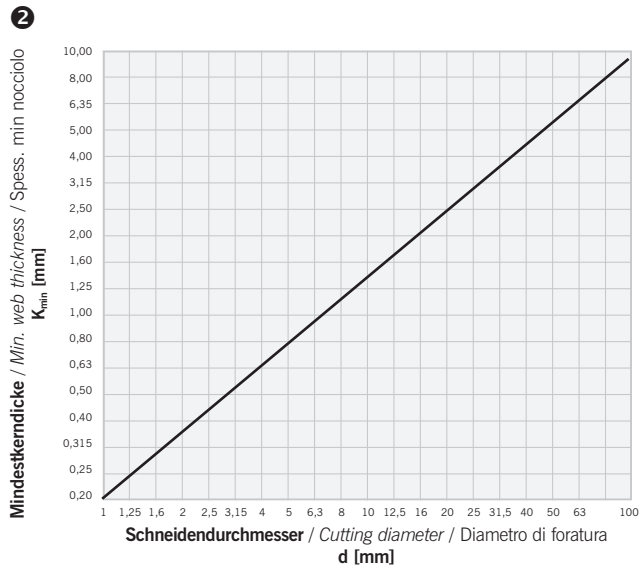
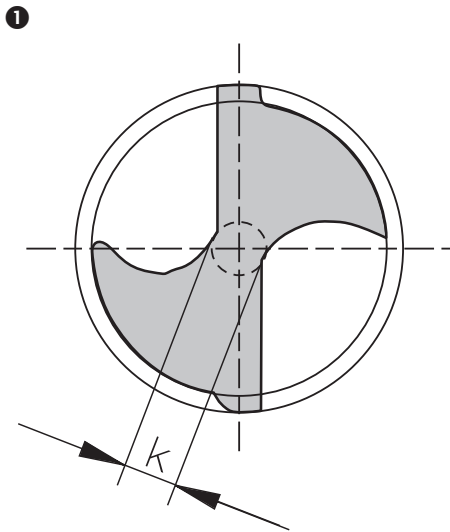

Prüfwerte:
Die Kerndicke (Abb. 1) sollte den in Abb. 2 angegebenen Mindestwert K_{min} nicht unterschreiten.

Prüfstelle:
An der Bohrerspitze

Prüfmittel:
Mess-Schieber (Schieblehre) mit Messerspitzen

Test values:
The web thickness according to (Fig. 1) shall not be less than the minimum value K_{min} indicated in Fig. 2.

Test point:
At the point of the drill

Testing equipment:
Slide gauge with measuring points

Oggetto di misura:
Lo spessore del nocciolo, come si può notare da fig. 1, non deve essere minore del minimo valore K_{min} indicato.

Punto di misura:
Al vertice della cuspid

Strumento di misura:
Calibro a punte

Fasenbreite b / *Margin width b* / Spessore della fase b

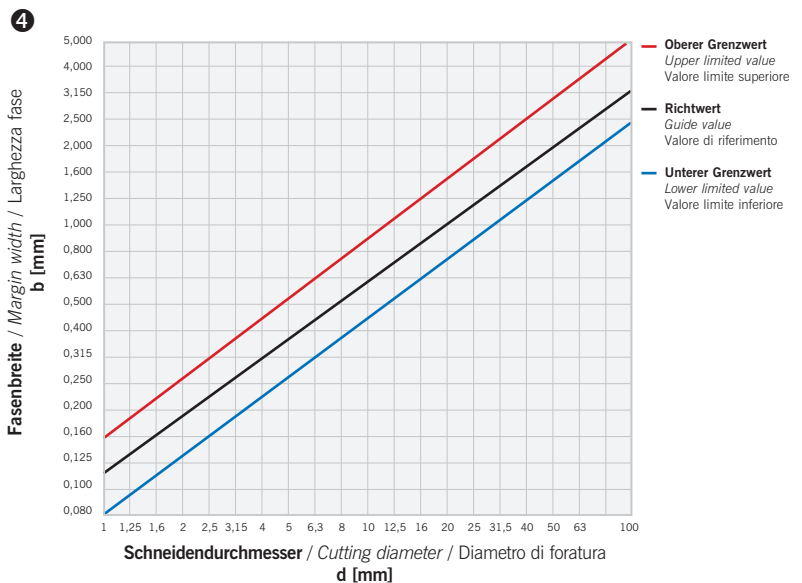
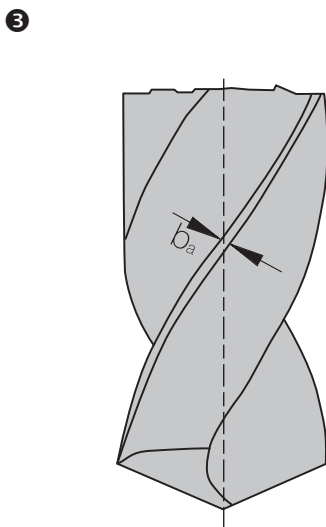

Prüfwerte:
Die Fasenbreite (Abb. 3) sollte im Bereich der Grenzwerte liegen, die in Abb. 4 angegeben sind.

Prüfstelle:
5 mm hinter der Schneidenecke

Prüfmittel:
Mess-Schieber

Test values:
The land width as in (Fig. 3) shall lie within the limiting values indicated in Fig. 4.

Test point:
5 mm behind the corner

Testing equipment:
Slide gauge

Oggetto di misura:
Lo spessore della fase, come in fig. 3, dovrebbe essere contenuta tra i valori riportati in fig. 4.

Punto di misura:
5 mm dalla cuspid

Strumento di misura:
Calibro

Seitenspanwinkel γ_f (Spiralwinkel) an SpiralbohrernSide rake angle γ_f (Helix angle) on twist drillsAngolo di spoglia laterale γ_f (angolo elica) su punte elicoidali

5

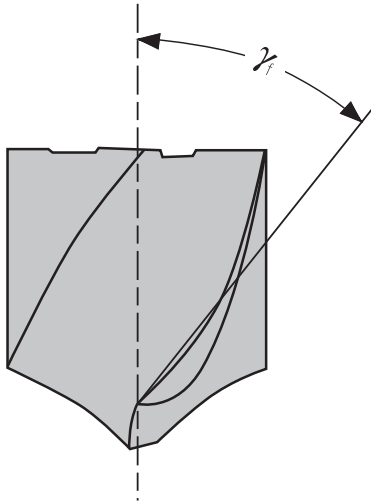

6

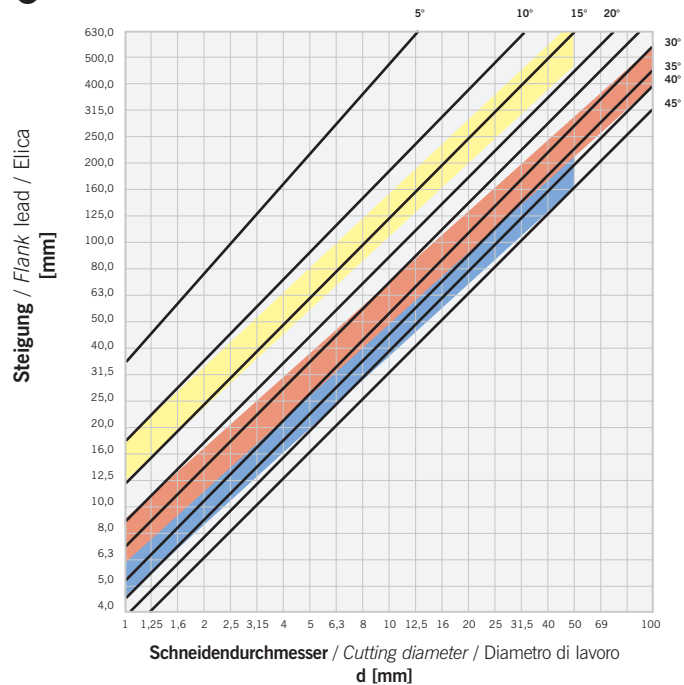
**Empfohlene Prüfwerte:****Empfohlene Bereiche in Abhängigkeit der Werkzeugtypen N, H und W nach DIN 1836 und des Schneiddurchmessers (Abb. 6).****Prüfstelle:**

An der Schneidenecke, siehe Abb. 5

Prüfmittel:

Nach der VDI-Richtlinie 3331 Blatt 1, Abschnitt Fasenbreite b

Anmerkung:Der Seitenspanwinkel γ_f wird an Stelle des in der Keilmessebene befindlichen Orthogonal-Spanwinkels γ_0 (siehe DIN 6581) gemessen, da sich dieser entlang der Hauptschneide verändert (er wird zur Bohrspitze kleiner).*Recommended test value:**Recommended ranges depending on the tool types N,H and W according to DIN 1836 and the diameter of the drill included in Fig. 6.**Test point:**At the corner, see Fig. 5.**Testing equipment:**According to VDI Guideline 3331 Part 1, Section Margin width b**Note:**The side rake angle γ_f is measured in place of the orthogonal rake angle γ_0 found in the wedge measuring plane (see DIN 6581), as this changes along the cutting edge (becoming smaller towards the point of the drill).***Verifiche raccomandate:**

Campi raccomandati in base al tipo di utensile N, H e W secondo DIN 1836 ed il diametro della punta (Fig. 6)

Punto di misura:

Sull'angolo, vedi Fig. 5

Strumenti di misura:

In riferimento a norme VDI 3331 Parte 1, Profilo sezione spessore b

Note:L'angolo di spoglia laterale γ_f viene misurato ortogonalmente all'angolo γ_0 (secondo DIN 6581) poiché l'angolo cambia lungo il tagliente (diventando minima verso il centro utensile).

Spitzenwinkel σ an Spiralbohrern

Point angle σ on twist drills

Angolo cuspidale su punta elicoidale σ

7

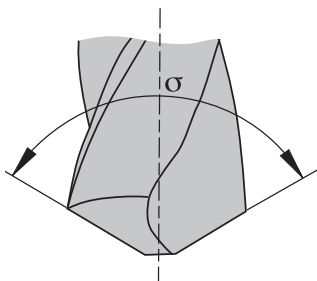

Spitzenwinkel σ
Point angle σ
Angolo cuspidale σ

Prüfwerte:

Regelausführung bei Werkzeugtyp N und H:
 $\alpha = 118$, bei Werkzeugtyp W: $\alpha = 130$

Prüfstelle:

An den Hauptschneiden, siehe Abb. 7

Prüfmittel:

Nach der VDI-Richtlinie 3331 Blatt 1,
Abschnitt Fasenbreite b_a

Test values:

*Usual execution for tool types N and H:
 $\alpha = 118$, for tool type W: $\alpha = 130$*

Test point:

At the cutting, see Fig. 7

Testing equipment:

*According to VDI Guideline 3331 Part 1,
Section Margin width b_a*

Oggetto di misura:

Normale esecuzione per utensili tipo N ed H:
 $\alpha = 118^\circ$, per tipo W: $\alpha = 130^\circ$

Punto di misura:

Lungo il tagliente, vedi Fig. 7

Strumento di misura:

Secondo le norme VDI 3331 Parte 1,
Sezione Spessore spoglia b_a

Nachschleifen von Spiralbohrern / Resharpening twist drills / Riaffilatura punte elicoidali

8

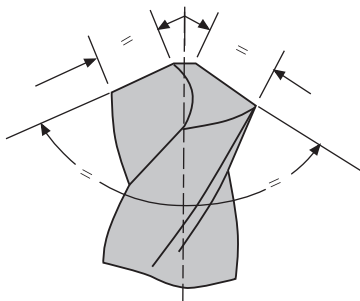

(1) Unregelmäßiger Verschleiß von Bohrern.
Bohrer sollte vor übermäßigem Verschleiß
nachgeschliffen werden.

(2) Nachschleifen

- a) Für Ihre Anwendung passenden korrekten Spitzenwinkel schleifen (Abb. 8).
- b) Überprüfen Sie, ob beide Hauptschneiden den gleichen Winkel haben. Bei einem 130° Spitzenwinkel sollte jede Hauptschneide 65° haben (Abb. 8)
- c) Primärer Hinterschliff und sekundärer Freiwinkel (Abb. 9).
- d) Ausgespitzten Kern schleifen (Abb. 10).

9

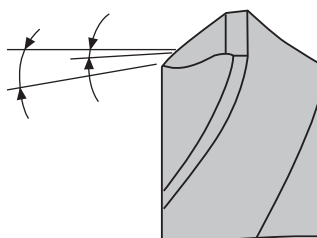

(1) Drills are worn off irregularly. It should be
sharpened prior to developing into excessive
wear.

(2) Resharpening

- a) Grind the correct point angle to suit your application (fig. 8).
- b) Check that both cutting lips have the same angle. On a 130° point, each lip should be 65° toward the axis. The point must be on center, i.e., the chisel edge must produce cutting lips of equal length (fig. 8).
- c) Grind Primary relief and Secondary clearance (figure 9).
- d) Grind web thinning (fig. 10).

10

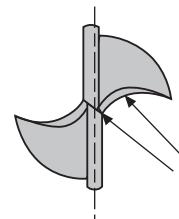

(1) Le punte elicoidali possono usarsi in modo
irregolare. Prevedere una corretta riaffilatura
in tempo utile ad evitare eccessivi danni.

(2) Riaffilatura

- a) Rettificare il corretto angolo di cuspidale in base all'applicazione (Fig. 8).
- b) Verificare che entrambi i taglienti siano sullo stesso angolo. Per una cuspidale di 130° , ogni tagliente deve trovarsi a 65° rispetto all'asse. La cuspidale deve trovarsi al centro e generare angolo di spoglia di uguale forma (Fig. 8)
- c) Rettificare la spoglia inferiore primaria e quella secondaria (Fig. 9)
- d) Rettificare il nocciolo della cuspidale (Fig. 10)

Kegelmantelschliff / *Web thinning* / Nocciole della cuspidi**Normalanschliff***Without thinning*
Senza affilatura nocciolo

Zum Bohren für allgemeine Zwecke. Dank dünner Kerndicke ist ein Kegelmantelschliff nicht nötig. Geeignet für Stahl, Stahllegierungen, Gusseisen, Edelstahl, Titan, Inconell usw. Für konventionelle Schneidbedingungen.

Suitable for drill of general purpose. Due to thin web thickness, web thinning is not needed. This type is applied for soft steel, alloyed steels, cast iron, stainless steel, titanium, inconell, etc. and conventional cutting conditons.

Idonea per forature generiche. Grazie al nocciolo sottile, l'affilatura del nocciolo di cuspidi non è necessaria. Questa tipologia risulta idonea alla lavorazione di acciai non legati, acciai debolmente legati, ghise, acciai inossidabili, titanio, Inconell in condizioni normali di lavoro.

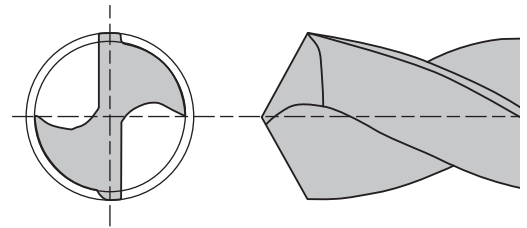
**DIN 1412 Form C Kegelmantelschliff mit Kreuzanschliff***Type C thinning (DIN 1412 Form C, split point)*
DIN 1412 Forma C Affilatura del nocciolo di cuspidi

Zum Bohren für allgemeine Zwecke. Geeignet für Stahl, Stahllegierungen, Gusseisen, Edelstahl, Titanlegierungen, Inconell usw. Für konventionelle Schneidbedingungen.

Because split point enables good centering when drilling and breaks the chips, chip removals is easy. Suitable drill design in high hardened tough materials, i.e., heat treated steel, titanium alloy, stainless steel, incoroy inconell, nimonic, etc.

Grazie alla cuspidi suddivisa, permette un buon centraggio e penetrazione nel materiale, oltre ad una migliore rottura del truciolo. Permette una evacuazione truciolo migliorata e quindi risulta idonea alla lavorazione di materiali duri, trattati, acciai, leghe di titanio, acciaio inossidabile, Inconoy, Inconell, nimonic, etc.

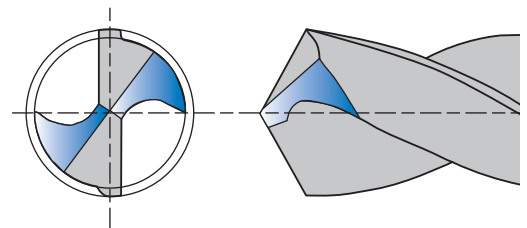
**Form R Kegelmantelschliff (Spiralanschliff)***Type R thinning (Helical thinning)*
Forma R Affilatura nocciolo elicoidale

Häufiger Spanbruch und Spanentfernung durch Spiralanschliff. Es wird ausreichend Raum für Späne geschaffen. Eine gute Zentrierung ist möglich.

Helical thinning ensure to frequent chip breaking and removal. The different direction force of cutting edges and helical thinning parts enables that chips curl, break and remove through the flutes. In addition, helical thinning makes the chip room up to center, remove the chisel and enables good centering.

L'affilatura elicoidale del nocciolo assicura una frequente rottura del truciolo e conseguente evacuazione. Le diverse forze di taglio risultanti sul tagliente aiutano il truciolo ad avvolgersi e a spezzarsi con maggior facilità. Inoltre, questo tipo di affilatura, aumenta la dimensione del vano truciolo, aiutando l'uscita e migliorando la centratura dell'utensile.

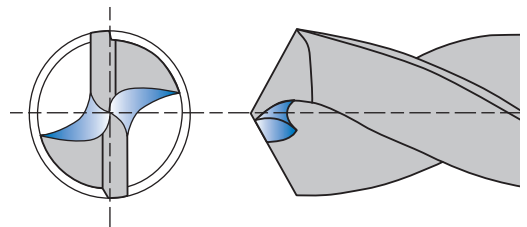
**DIN 1412 Form A Kegelmantelschliff mit ausgespitzer Querschnitte***Type A thinning (DIN 1412 Form A)*
DIN 1412 Form A Assottigliamento del nocciolo sulla cuspidi

Diese Form hat eine dünne Querschnitte, dadurch ist eine gute Spanentfernung und Zentrierung möglich. Der Kegelmantelschliff ist bei dieser Form am einfachsten nachzuschleifen. Ein enger Kern und breite Schneiden erhalten die Stabilität.

A type thinning makes thin chisel, good chip removal and favorable centering. This type is the easiest type to grind the thinning. In narrow web and wide fluted drills, keeping of the rigidity and smooth chip removal are possible.

L'assottigliamento di tipo A crea un tagliente trasversale fine, una buona evacuazione truciolo e un favorito centraggio. Questo tipo è il più facile da realizzare. Uno spessore del nocciolo ridotto e un'elica più larga favoriscono la stabilità.

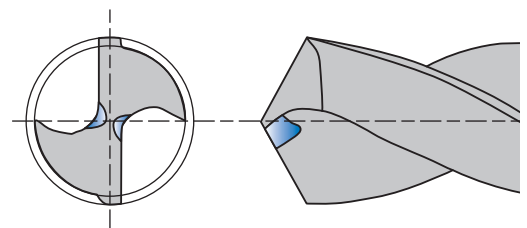

Kegelmantelschliff / Web thinning / Nocciolo della cuspide**DIN 1412 Form B****Kegelmantelschliff mit ausgespitzer Querschneide**

Type B thinning (DIN 1412 Form B)

DIN 1412 Forma B Assottigliamento del nocciolo e del petto di spoglia

Gute Spanentfernung z.B. bei Gusseisen, Aluminium, Kunststoffen usw. Diese Form wird besonders dann angewendet, wenn der Bohrer für Stähle mit hoher Härte produziert wurde, da dadurch der Seitenspanwinkel verkleinert wird und Brüche an der Schneidkante vermieden werden.

In case of work materials with low cutting resistance and good chip removal, ie, cast iron, aluminium, plastic etc., B type thinning is suitable. Especially when drills for high hardened steels are designed, this type is applied to decrease rake angle and avoid chipping of cutting lips.

L'assottigliamento tipo B è suggerito nel caso in cui si stiano lavorando materiali con bassa resistenza alla lavorabilità e buona evacuazione truciolo; per esempio ghisa, alluminio, plastica, ecc... Questo tipo di assottigliamento è utilizzato soprattutto quando le punte sono modellate per lavorare acciai fortemente induriti al fine di ridurre l'angolo di spoglia superiore e evitare la scheggiatura dei taglienti.

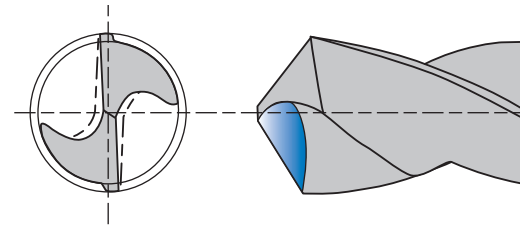
**DIN 1412 Form D****Kegelmantelschliff mit ausgespitztem Kern**

Type D thinning (DIN 1412 Form D)

DIN 1412 Forma D Assottigliamento con smusso dello spigolo

GG-Anschliff. Fasen auf dem Steg verstärken die Schneidkante. Geeignet für mittlere und hochharte Graugusswerkstoffe sowie für abrasive Materialien.

Gray Castiron thinning; bevelling of external edges strengthens the cutting edge. Used for medium to high gray cast iron hardness and for abrasives.

Assottigliamento per ghisa grigia; smussi sui lati esterni e irrobustimento dei lati taglienti. Usato su ghisa grigia di media/alta durezza e per materiali abrasivi.

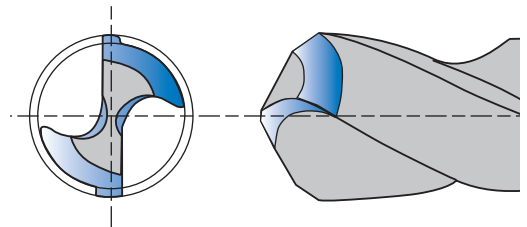
**DIN 1412 Form E Zentrums Spitze**

Type E thinning (DIN 1412 Form E)

DIN 1412 Forma E Centrino

Zum zentrischen Bohren von dünnen Blechen und Röhren geeignet. Niedrige Gratbildung.

Centre drill bit thinning; ensures optimal centre drilling and does not leave burrs in through-holes. As the bit and cutting edges are delicate, this bit should be used for drilling thin sheet metal.

Assottigliamento con centrino pilota; assicura un' ottimale centratura del foro ed evita la rottura in uscita nei fori passanti. Sia il centrino che i lati tagliente sono delicati, questa punta può essere usata per forare lamiere di ridotto spessore e tubi.

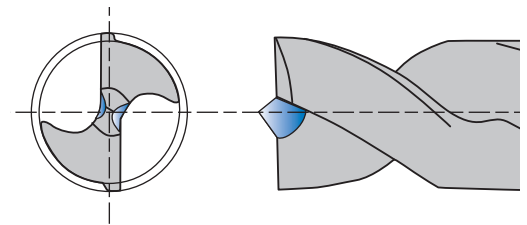

Durchmesser der Bohrwerkzeuge für Gewindekernlöcher

Drill sizes before tapping

Diametro dei prefori di maschiatura

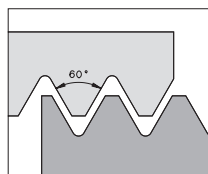

Metrisches ISO Gewinde DIN 13
Metric ISO DIN 13
Metrico ISO Filettatura ISO DIN 13

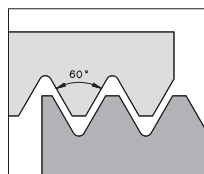

Metrisches ISO Feingewinde DIN 13
Metric ISO fine pitch DIN 13
Metrico ISO Filettatura DIN 13

Gewindedurchmesser Thread diameter Diametro filetto	Steigung Pitch Passo	Kernloch-Mutter Bore diameter nut Diametro preforo
[M]	[mm]	[mm]
1,0	0,25	0,75
1,1	0,25	0,85
1,2	0,25	0,95
1,4	0,30	1,10
1,6	0,35	1,25
1,8	0,35	1,45
2,0	0,40	1,60
2,2	0,45	1,75
2,5	0,45	2,05
3,0	0,50	2,50
3,5	0,60	2,90
4,0	0,70	3,30
4,5	0,75	3,70
5,0	0,80	4,20
6,0	1,00	5,00
7,0	1,00	6,00
8,0	1,25	6,80
9,0	1,25	7,80
10,0	1,50	8,50
11,0	1,50	9,50
12,0	1,75	10,20
14,0	2,00	12,00
16,0	2,00	14,00
18,0	2,50	15,50
20,0	2,50	17,50
22,0	2,50	19,50
24,0	3,00	21,00
27,0	3,00	24,00
30,0	3,50	26,50
33,0	3,50	29,50
36,0	4,00	32,00
39,0	4,00	35,00
42,0	4,50	37,50
45,0	4,50	40,50
48,0	5,00	43,00
52,0	5,00	47,00
56,0	5,50	50,50
60,0	5,50	54,50
64,0	6,00	58,00
68,0	6,00	62,00

Gewindedurchmesser Thread diameter Diametro filetto	Kernloch-Mutter Bore diameter nut Diametro preforo
[M]	[mm]
2,00 x 0,25	1,75
2,20 x 0,25	1,95
2,30 x 0,25	2,05
2,50 x 0,35	2,15
2,60 x 0,35	2,20
3,00 x 0,35	2,65
3,50 x 0,35	3,15
4,00 x 0,35	3,65
4,00 x 0,50	3,50
5,00 x 0,50	4,50
6,00 x 0,50	5,50
6,00 x 0,75	5,20
7,00 x 0,75	6,20
8,00 x 0,50	7,50
8,00 x 0,75	7,20
8,00 x 1,00	7,00
9,00 x 0,75	8,20
9,00 x 1,00	8,00
10,00 x 0,50	9,50
10,00 x 0,75	9,20
10,00 x 1,00	9,00
10,00 x 1,25	8,80
11,00 x 1,00	10,00
12,00 x 0,75	11,20
12,00 x 1,00	11,00
12,00 x 1,25	10,80
12,00 x 1,50	10,50
13,00 x 1,00	12,00
14,00 x 1,00	13,00
14,00 x 1,25	12,80
14,00 x 1,50	12,50
15,00 x 1,00	14,00
15,00 x 1,50	13,50
16,00 x 1,00	15,00
16,00 x 1,50	14,50
18,00 x 1,00	17,00
18,00 x 1,50	16,50
18,00 x 2,00	16,00
20,00 x 1,00	19,00
20,00 x 1,50	18,50
20,00 x 2,00	18,00
22,00 x 1,00	21,00
22,00 x 1,50	20,50

Gewindedurchmesser Thread diameter Diametro filetto	Kernloch-Mutter Bore diameter nut Diametro preforo
[M]	[mm]
22,00 x 2,00	20,00
24,00 x 1,00	23,00
24,00 x 1,50	22,50
24,00 x 2,00	22,00
25,00 x 1,00	24,00
25,00 x 1,50	23,50
26,00 x 1,50	24,50
27,00 x 1,50	25,50
27,00 x 2,00	25,00
28,00 x 1,50	26,50
28,00 x 2,00	26,00
30,00 x 1,00	29,00
30,00 x 1,50	28,50
30,00 x 2,00	28,00
32,00 x 1,50	30,50
33,00 x 1,50	31,50
33,00 x 2,00	31,00
34,00 x 1,50	32,50
35,00 x 1,50	33,50
36,00 x 1,50	34,50
36,00 x 2,00	34,00
36,00 x 3,00	33,00
38,00 x 1,50	36,50
39,00 x 1,50	37,50
39,00 x 2,00	37,00
39,00 x 3,00	36,00
40,00 x 1,50	38,50
40,00 x 2,00	38,00
40,00 x 3,00	37,00
42,00 x 1,50	40,50
42,00 x 2,00	40,00
42,00 x 3,00	39,00
45,00 x 1,50	43,50
45,00 x 2,00	43,00
45,00 x 3,00	42,00
48,00 x 1,50	46,50
48,00 x 2,00	46,00
48,00 x 3,00	45,00
50,00 x 1,50	48,50
50,00 x 2,00	48,00
50,00 x 3,00	47,00
52,00 x 1,50	50,50
52,00 x 2,00	50,00
52,00 x 3,00	49,00

Durchmesser der Bohrwerkzeuge für Gewindekernlöcher

Drill sizes before tapping

Diametro dei prefori di maschiatura

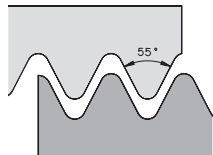
**Whitworth Rohrgewinde DIN ISO 228**

Whitworth pipe thread DIN ISO 228

Whitworth Filettatura DIN ISO 228

Gewindebezeichnung Thread Designation Diametro filettatura	Durchmesser außen Diameter external Diametro esterno		Durchmesser Mutter Diameter nut Diametro Nominale	Durchmesser Kernloch Bore diameter Diametro Foro	Gänge je Pitches per Filetti per pollice
	[inch]	[mm]	[mm]	[mm]	[inch]
G 1/8"	1/8	9,73	8,85	8,80	28
G 1/4"	1/4	13,16	11,89	11,80	19
G 3/8"	3/8	16,66	15,39	15,25	19
G 1/2"	1/2	20,95	19,17	19,00	14
G 5/8"	5/8	22,91	21,13	21,00	14
G 3/4"	3/4	26,44	24,66	24,50	14
G 7/8"	7/8	30,20	28,42	28,25	14
G 1"	1	33,25	30,93	30,75	11
G 1 1/8"	1 1/8	37,90	35,58	35,30	11
G 1 1/4"	1 1/4	41,91	39,59	39,25	11
G 1 3/8"	1 3/8	44,32	42,00	41,70	11
G 1 1/2"	1 1/2	47,80	45,48	45,25	11
G 1 3/4"	1 3/4	53,74	51,43	51,10	11
G 2"	2	59,61	57,29	57,00	11
G 2 1/4"	2 1/4	65,71	63,39	63,10	11
G 2 1/2"	2 1/2	75,18	72,86	72,60	11
G 2 3/4"	2 3/4	81,53	79,21	78,90	11
G 3"	3	87,88	85,56	85,30	11
G 3 1/4"	3 1/4	93,98	91,66	91,50	11
G 3 1/2"	3 1/2	100,33	98,01	97,70	11
G 3 3/4"	3 3/4	106,68	104,30	104,00	11
G 4"	4	113,03	110,71	110,40	11

Durchmesser der Bohrwerkzeuge für Gewindekernlöcher

Drill sizes before tapping

Diametro dei prefori di maschiatura

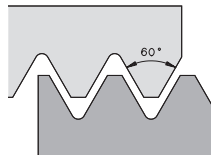
**UNC-Gewinde ANSI B1.1**

UNC-thread ANSI B1.1

UNC Filettatura ANSI B1.1

Gewindebezeichnung Thread Designation Diametro filettatura	Durchmesser außen Diameter external Diametro esterno		Durchmesser Mutter Diameter nut Diametro Nominale	Durchmesser Kernloch Bore diameter Diametro Foro		Gänge je Pitches per Filetti per pollice
	[inch]	[mm]	[mm]	[mm]	[inch]	
N 1 - 64 UNC	0,073	1,854	0,059	1,50	56,0	
N 2 - 56 UNC	0,086	2,184	0,071	1,80	48,0	
N 3 - 48 UNC	0,099	2,515	0,083	2,10	40,0	
N 4 - 40 UNC	0,112	2,845	0,093	2,35	40,0	
N 5 - 40 UNC	0,125	3,175	0,104	2,65	32,0	
N 6 - 32 UNC	0,138	3,505	0,112	2,85	32,0	
N 8 - 32 UNC	0,164	4,166	0,138	3,50	14,0	
N 10 - 24 UNC	0,190	4,826	0,157	4,00	24,0	
N 12 - 24 UNC	0,216	5,486	0,183	4,65	20,0	
1/4" - 20 UNC	0,250	6,350	0,211	5,35	18,0	
5/16" - 18 UNC	0,313	7,938	0,268	6,80	16,0	
3/8" - 16 UNC	0,375	9,525	0,325	8,25	14,0	
7/16" - 14 UNC	0,438	11,112	0,380	9,65	13,0	
1/2" - 13 UNC	0,500	12,700	0,439	11,15	12,0	
9/16" - 12 UNC	0,563	14,288	0,496	12,60	11,0	
5/8" - 11 UNC	0,625	15,875	0,553	14,05	10,0	
3/4" - 10 UNC	0,750	19,050	0,669	17,00	9,0	
7/8" - 9 UNC	0,875	22,225	0,787	20,00	8,0	
1" - 8 UNC	1,000	25,400	0,900	22,85	7,0	
1 1/8" - 7 UNC	1,125	28,575	1,010	25,65	7,0	
1 1/4" - 7 UNC	1,250	31,750	1,136	28,85	6,0	
1 3/8" - 6 UNC	1,375	43,925	1,242	31,55	6,0	
1 1/2" - 6 UNC	1,500	38,100	1,366	34,70	5,0	
1 3/4" - 5 UNC	1,750	44,450	1,591	40,40	4,5	
2" - 4 1/2 UNC	2,000	50,800	1,823	46,30	4,5	
2 1/4" - 4 1/2 UNC	2,250	57,150	2,073	52,65	4,0	
2 1/2" - 4 UNC	2,500	63,500	2,303	58,50	4,0	
2 3/4" - 4 UNC	2,750	69,850	2,549	64,75	4,0	
3" - 4 UNC	3,000	63,500	2,799	71,10	4,0	
3 1/4" - 4 UNC	3,250	82,550	3,049	77,45	4,0	
3 1/2" - 4 UNC	3,500	88,900	3,299	83,80	4,0	
3 3/4" - 4 UNC	3,750	95,250	3,549	90,15	4,0	
4" - 4 UNC	4,000	101,600	3,799	96,50	4,0	

Durchmesser der Bohrwerkzeuge für Gewindekernlöcher

Drill sizes before tapping

Diametro dei prefori di maschiatura

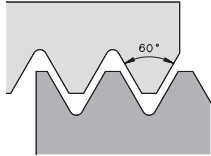
**UNF-Gewinde ANSI B1.1**

UNF-thread ANSI B1.1

UN-Filettatura ANSI B1.1

Gewindebezeichnung Thread Designation Diametro filettatura	Durchmesser außen Diameter external Diametro esterno	Durchmesser außen Diameter external Diametro esterno	Durchmesser Kernloch Bore diameter Diametro Foro	Gänge je Pitches per Filetti per pollice
	[inch]	[mm]	[mm]	[inch]
N 0 - 80 UNF	0,060	1,524	1,25	80
N 1 - 72 UNF	0,073	1,854	1,55	72
N 2 - 64 UNF	0,068	2,184	1,90	64
N 3 - 56 UNF	0,099	2,515	2,15	56
N 4 - 48 UNF	0,112	2,845	2,40	48
N 5 - 44 UNF	0,125	3,175	2,70	44
N 6 - 40 UNF	0,138	3,505	2,95	32
N 8 - 36 UNF	0,164	4,166	3,50	36
N 10 - 32 UNF	0,190	4,826	4,10	32
N 12 - 28 UNF	0,216	5,486	4,70	28
1/4" - 28 UNF	0,250	6,350	5,50	28
5/16" - 24 UNF	0,313	7,938	6,90	24
3/8" - 24 UNF	0,375	9,525	8,50	24
7/16" - 20 UNF	0,438	11,112	9,90	20
1/2" - 20 UNF	0,500	12,700	11,50	20
9/16" - 18 UNF	0,563	14,288	12,90	18
5/8" - 18 UNF	0,625	15,875	14,50	18
3/4" - 10 UNF	0,750	19,050	17,50	16
7/8" - 14 UNF	0,875	22,225	20,40	14
1" - 12 UNF	1,000	25,400	23,25	12
1 1/8" - 12 UNF	1,125	28,575	26,50	12
1 1/4" - 12 UNF	1,250	31,750	29,50	12
1 3/8" - 12 UNF	1,375	43,925	32,75	12
1 1/2" - 12 UNF	1,500	38,100	36,00	12

ISO-Toleranz / ISO tolerance / Tolleranze ISO

Durchmesser Diameter Diametro	von bis/from to/da a	von bis/from to/da a	von bis/from to/da a	von bis/from to/da a	von bis/from to/da a	von bis/from to/da a
	1-3	3-6	6-10	10-18	18-30	30-50
	Toleranz in μm / Tolerance in μm / Valori in μm					
h6	0 -6	0 -8	0 -9	0 -11	0 -13	0 -16
h7	0 -10	0 -12	0 -15	0 -18	0 -21	0 -25
h8	0 -14	0 -18	0 -22	0 -27	0 -33	0 -39
m7	+12 +2	+16 +4	+21 +6	+25 +7	+29 +8	+34 +9

Probleme und Abhilfe

Problem	Ursache	Mögliche Abhilfe
Bohrer dringt nicht durch das Werkstück	1. Bohrer stumpf 2. Hauptschneide zu klein 3. Kern zu dick	1. Schleifen der Hauptschneide 2. Kegelmantel schleifen 3. Bohrer mit engerem Kern wählen
Fasenbruch	1. Bohrbuchse ist zu ungenau	1. Die passende Bohrbuchse wählen
Bruch der Hauptschneide	1. Zu große Belastung der Hauptschneide 2. Vorschub zu hoch	1. Schleifen der Hauptschneide 2. Vorschub verringern
Bruch der Austreiblappen am Kegelschaft	1. Befestigung zwischen Morsekegel und Aufnahme ungenügend 2. Verschleiß der Aufnahme	1. Schmutz oder Späne in der Aufnahme entfernen 2. Aufnahme wechseln
Bohrer bricht in Messing	1. Unpassender Bohrer 2. Schneiden durch Späne verstopft	1. Passenden Bohrer wählen
Brüche auf der Querschneide	1. Zu große Belastung der Querschneide 2. Vorschub zu hoch	1. Schleifen der Querschneide 2. Vorschub verringern
Übergröße der Bohrung	1. Ungleicher Winkel oder Länge der Hauptschneiden 2. Lockere Spindel	1. Nachschleifen der Bohrspitze, passenden Bohrer wählen 2. Spindel ausreichend befestigen
Brüche an der Schneidenecke	1. Schnittgeschwindigkeit zu hoch 2. Harte Einschlüsse im Werkstück 3. Schneiden durch Späne verstopft 4. Verschleiß des Bohrers zu groß	1. Bohrspitze nachschleifen, an Werkstück anpassen 2. Vorschub verringern 3. Nachschleifen vor zu großem Verschleiß
Ungleiche Späne an den Schneiden	1. Bohrspitze nicht richtig geschliffen 2. Nur eine Schneide bohrt	1. Bohrspitze richtig schleifen 2. Bohrspitze mit dem gleichen Spitzenwinkel und Länge nachschleifen
Schlechtes Bohrbild	1. Bohrspitze nicht richtig geschliffen 2. Ungenügende Kühlmittelzufuhr 3. Vorschub zu hoch 4. Befestigung nicht stabil	1. Bohrspitze richtig schleifen 2. Genügend Kühlmittel zuführen 3. Vorschub verringern 4. Befestigung stabilisieren oder erneuern

Trouble shooting in drilling

Occurrence of trouble	Cause of trouble	Countermeasures
Drill will not enter workpiece	<ol style="list-style-type: none"> 1. Drill is dull 2. Lip relief too small 3. Too thick a web 	<ol style="list-style-type: none"> 1. Grind lip relief sufficiently 2. Grind web thinning 3. Choose a drill with narrow web
Margin chipping	<ol style="list-style-type: none"> 1. Oversized bush 	<ol style="list-style-type: none"> 1. Choose the suitable bush for drill diameter
Cutting lip breaks	<ol style="list-style-type: none"> 1. Lip relief too much 2. Feed too heavy 	<ol style="list-style-type: none"> 1. Grind lip relief sufficiently 2. Decrease feed rate
Tang breaks	<ol style="list-style-type: none"> 1. Imperfect fit between taper shank and socket 2. Burred or Badly worn sockets 	<ol style="list-style-type: none"> 1. Clean the dirt or chips in sockets 2. Change the worn sockets to new ones
Drill breaks in brass	<ol style="list-style-type: none"> 1. Unsuited drill 2. Flutes clogged with chips 	<ol style="list-style-type: none"> 1. Choose the suitable drill for work material
Chipping of drill center	<ol style="list-style-type: none"> 1. Lip relief too much 2. Feed too heavy 	<ol style="list-style-type: none"> 1. Grind lip relief sufficiently 2. Decrease feed rate
Hole oversize	<ol style="list-style-type: none"> 1. Unequal angle or length of edges 2. Loosen spindle 	<ol style="list-style-type: none"> 1. Resharpener point, choose correct drills 2. Tighten spindle sufficiently
Outer corners break down	<ol style="list-style-type: none"> 1. Cutting speed too high 2. Hard spots in work material 3. Flutes clogged with chips 4. Drill is too worn 	<ol style="list-style-type: none"> 1. Grind point to suit work material 2. Decrease the feed rates 3. Resharpener early before too worn
Large chip of one flute and small chip of other flute	<ol style="list-style-type: none"> 1. Improperly ground point 2. Only one lip doing all the cutting 	<ol style="list-style-type: none"> 1. Properly grind point 2. Grind point with same point angle and length of lip
Hole rough	<ol style="list-style-type: none"> 1. Improperly ground point 2. Unenough coolant supply 3. Too much feed 4. Fixture not rigid 	<ol style="list-style-type: none"> 1. Properly grind point 2. Supply coolant enoughly 3. Decrease the feed rate 4. Tighten the fixture or replace

Problemi e Suggerimenti

Problema	Possibili cause	Suggerimenti
La punta non penetra nel pezzo da lavorare	<ol style="list-style-type: none"> 1. La punta non è affilata 2. Filo tagliente troppo piccolo 3. Anima troppo spessa 	<ol style="list-style-type: none"> 1. Riaffilare filo tagliente 2. Ridurre lo spessore del nocciolo 3. Utilizzare una punta con un'anima più fine
Scheggiatura sull'elica	<ol style="list-style-type: none"> 1. Boccole guida inappropriate 	<ol style="list-style-type: none"> 1. Cambiare le boccole guida
Rottura del filo tagliente	<ol style="list-style-type: none"> 1. Tagliente scaricato eccessivamente 2. Avanzamenti elevati 	<ol style="list-style-type: none"> 1. Affilare correttamente lo scarico del tagliente 2. Ridurre l'avanzamento
Rottura del corpo punta o del codolo	<ol style="list-style-type: none"> 1. Accoppiamento imperfetto tra gambo utensile e porta utensile 2. Porta utensili con bave o usurati 	<ol style="list-style-type: none"> 1. Pulire o togliere i trucioli dal porta utensili 2. Sostituire il porta utensili
Su lavorazioni di ottone la punta si rompe	<ol style="list-style-type: none"> 1. Punta non adatta 2. Scarsa evacuazione truciolo 	<ol style="list-style-type: none"> 1. Scegliere punta idonea
Scheggiatura della cuspid	<ol style="list-style-type: none"> 1. Taglienti troppo affilati 2. Avanzamento troppo elevato 	<ol style="list-style-type: none"> 1. Predisporre affilatura idonea 2. Adottare parametri di taglio idonei
Foro maggiorato	<ol style="list-style-type: none"> 1. Angoli dei taglienti diversi tra loro 2. Serraggio mandrino insufficiente 	<ol style="list-style-type: none"> 1. Riaffilare correttamente la punta, scegliere la punta adatta 2. Serrare il mandrino a sufficienza
Gli spigoli esterni della punta di scheggiano	<ol style="list-style-type: none"> 1. Velocità di taglio troppo elevata 2. Zone più dure nel materiale da lavorare 3. Scarichi otturati dai trucioli 4. La punta è troppo usurata 	<ol style="list-style-type: none"> 1. Diminuire la velocità di taglio 2. Affilare la punta correttamente in base al materiale da lavorare 3. Riaffilare la punta più frequentemente
Trucioli grossi in uno scarico e piccoli nell'altro	<ol style="list-style-type: none"> 1. Affilatura della punta inappropriata 2. Un solo tagliente della punta stà lavorando 	<ol style="list-style-type: none"> 1. Riaffilare appropriatamente la punta 2. Affilare la punta in modo da ottenere un angolo simmetrico e una lunghezza uguale tra i due taglienti
Scarsa finitura superficiale	<ol style="list-style-type: none"> 1. Affilatura della punta inappropriata 2. Erogazione refrigerante insufficiente 3. Avanzamento troppo elevato 4. Dispositivo di serraggio non sufficientemente rigido 	<ol style="list-style-type: none"> 1. Affilare appropriatamente la punta 2. Aumentare l'adduzione del refrigerante 3. Diminuire l'avanzamento 4. Serrare a sufficienza o sostituire il dispositivo di serraggio

Formeln / Formulas / Formule

Schnittgeschwindigkeit

Cutting speed

Velocità di taglio [m/min]

$$V_c = \frac{n \cdot \pi \cdot d}{1000}$$

Spezifische Schnittkraft

Special cutting force

Forza di taglio specifica

$$k_c = k \cdot C_1 \cdot C_2$$

Vorschubgeschwindigkeit

Feed rate

Velocità di avanzamento [mm/min]

$$V_f = n \cdot f$$

Zeitspanvolumen

Chip removal rate

Volume truciolo

$$Q = \frac{A \cdot V_c}{2}$$

Drehzahl

Revolutions

Velocità di rotazione [U/min]

$$n = \frac{1000 \cdot V_c}{\pi \cdot d}$$

Spanungsquerschnitt

Chip thickness

Spessore medio truciolo [mm²]

$$A = \frac{d \cdot f}{2}$$

Schnittleistung

Drilling power

Assorbimento potenza [kW]

$$P_c = \frac{K_c \cdot f \cdot d \cdot V_c}{240000}$$

V_f	Vorschubgeschwindigkeit <i>Feed rate</i> Velocità di avanzamento	[mm/min]	P_c	Schnittleistung <i>Cutting rate</i> Assorbimento potenza	[kW]	C₁	Korrekturfaktor für die Schnittgeschwindigkeit <i>Correction factor for cutting speed</i> Fattore di correzione per velocità di taglio
V_c	Schnittgeschwindigkeit <i>Cutting speed</i> Velocità di taglio	[m/min]	A	Spanungsquerschnitt <i>Chip thickness</i> Spessore medio truciolo	[mm ²]	C₂	Korrekturfaktor für das Fertigungsverfahren <i>Correction factor for manufacturing process</i> Fattore di correzione per processo produttivo
n	Drehzahl <i>Revolution per minute</i> Velocità di rotazione	[U/min]	Q	Zeitspanvolumen <i>Chip removal rate</i> Volume truciolo		K	Tabellenwert für die spezifische Schnittkraft <i>Value for specific cutting force</i> Valore per specifiche forze di taglio
f	Vorschub <i>Feed rate</i> Avanzamento	[mm/U]	k_c	Spezifische Schnittkraft <i>Chip thickness</i> Coefficiente di taglio	[N/mm ²]		

Tipp:

Gerne sind wir Ihnen bei der Berechnung der richtigen Werte behilflich! Rufen Sie einfach unser Kompetenz-Team an! Bitte halten Sie dafür Durchmesser, Bohrtiefe und Materialdaten bereit. In kürzester Zeit haben wir alle Daten für Sie errechnet!

Tip:

We would be glad to calculate your figures. Please have the following informations when you call: Diameter, depth and material grade. We will be happy to help.

Suggerimento:

Saremo lieti di calcolare I vostri valori. Al momento della telefonata prego fornirci: diametro, profondità e tipo di materiale. Siamo sempre al vostro servizio.

Set Drehmoment-Schraubendreher

Set Torque screwdriver

Set Manico dinamometrico

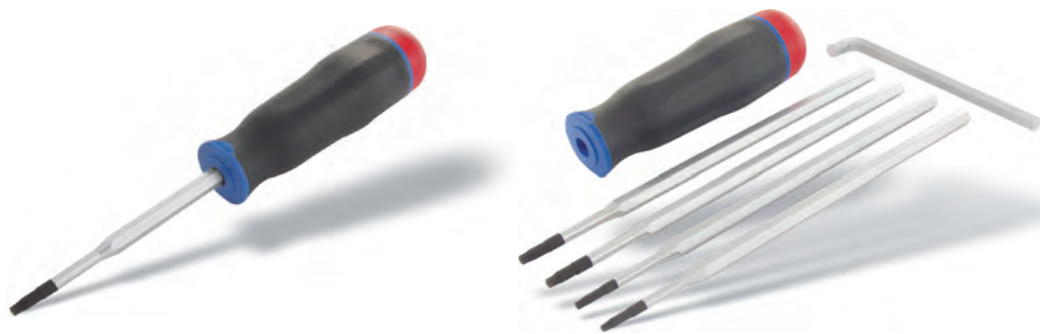

Set 1

Einstellbereich von 0,6 Nm–1,5 Nm

Adjustable from 0.6 Nm–1.5 Nm

Registabile da 0,6 Nm–1,5 Nm

- 1 Drehmoment-Schraubendreher
- je 1 Hochleistungsklinge Torx T6, Torx T7, Torx T8 und Torx T9
- 1 Einstellschlüssel

- 1 Torque screwdriver
- 1 each bits Torx T6, Torx T7, Torx T8 and Torx T9
- 1 Adjustment key

- 1 Manico dinamometrico
- 1 Set di chiavi per Torx T6, T7, T8, T9
- 1 chiave di registrazione

(Bestellbezeichnung: **Set-Drehmoment 1**)

(Ordering code: **Set-Torque 1**)

(Esempio di ordinazione:
Set Manico dinamometrico 1)

Set 2

Einstellbereich von 1,5 Nm–3,0 Nm

Adjustable from 1.5 Nm–3.0 Nm

Registabile da 1,5 Nm–3,0 Nm

- 1 Drehmoment-Schraubendreher
- je 1 Hochleistungsklinge Torx T9, Torx T10 und Torx T15
- 1 Einstellschlüssel

- 1 Torque screwdriver
- 1 each bits Torx T9, Torx T10 and Torx T15
- 1 Adjustment key

- 1 Manico dinamometrico
- 1 Set di chiavi per Torx T9, T10, T15
- 1 chiave di registrazione

(Bestellbezeichnung: **Set-Drehmoment 2**)

(Ordering code: **Set-Torque 2**)

(Esempio di ordinazione:
Set Manico dinamometrico 2)

Set 3

Einstellbereich von 3,0 Nm–5,4 Nm

Adjustable from 3.0 Nm–5.4 Nm

Registabile da 3,0 Nm–5,4 Nm

- 1 Drehmoment-Schraubendreher
- je 1 Hochleistungsklinge Torx T10, Torx T15 und Torx T20
- 1 Einstellschlüssel

- 1 Torque screwdriver
- 1 each bits Torx T10, Torx T15 and Torx T20
- 1 Adjustment key

- 1 Manico dinamometrico
- 1 Set di chiavi per Torx T10, T15, T20,
- 1 chiave di registrazione

(Bestellbezeichnung: **Set-Drehmoment 3**)

(Ordering code: **Set-Torque 3**)

(Esempio di ordinazione:
Set Manico dinamometrico 3)

Zulässige Anzugsmomente für Wendeschneidplatten – Spannelemente /

Recommended torque settings for inserts / Momenti di serraggio suggeriti per viti inserti

Gewinde Thread Filo	Torx-Größe Torx size Torx-Dimensione	max. Anzugsmoment max. torque Massimo momento torcente
M1,8	T6	0,6 Nm
M2	T6	0,6 Nm
M2	T7	0,6 Nm
M2,2	T6	1,0 Nm
M2,2	T7	1,0 Nm
M2,2	T8	1,3 Nm
M3	T8	2,2 Nm
M3	T9	2,2 Nm
M3,5	T15	3,4 Nm
M4	T15	5,1 Nm
M4,5	T20	6,2 Nm
M5	T20	6,2 Nm
M6	T25	8,1 Nm

Alphanumerischer Index

Alphanumerical index

Indice alfanumerico

Bezeichnung Designation Désignation	Seite Page Pagina
A	
AKB2... (Ø14-Ø45)	152-153
AKB3... (Ø14-Ø45)	154-155
H	
HA950-1107... GMK2	52
HA950-1107... GW16	38
HA950-1107... GW20	38-39
HA950-1107... SPMK2	52
HA950-1107... SPMK2-G	53
HA950-1107... SPW20	38
HA950-1107... SPW20-W	38
HC1110-1295... GMK2	52-53
HC1110-1295... GW16	39
HC1110-1295... GW20	39-40
HC1110-1295... SPMK2	54
HC1110-1295... SPMK2-G	54
HC1110-1295... SPW20	40
HC1110-1295... SPW20-W	40
HE1298-1765... GMK2	55
HE1298-1765... GW20	41/43
HE1298-1765... SPW20	42-43
HE1298-1765... SPW20-W	42
HE1298-1765... SPMK2	56
HE1550-1765... SPMK2-G	57
HG1550-1765... GMK2	55
HG1550-1765... GW20	41
HG1550-1765... SPMK2	56
HG1550-1765... SPW20	43
HI1753-2436... GMK3	57/59
HI1753-2436... GMK3-G	59
HI1753-2438... GW25	44/46
HI1753-2438... GW25-W	44
HI1753-2438... SPMK3	58
HI1753-2438... SPMK3-G	59
HI1753-2438... SPW25	45
HI1753-2438... SPW25-W	45
HK2200-2438... GMK3	58
HK2200-2438... GW25	44
HK2200-2438... SPMK3	59
HK2200-2438... SPMK3-G	60
HK2200-2438... SPW25	45
HM2441-3505... GMK4	60
HM2441-3505... GMK4-G	62
HM2441-3505... GW32	46/48
HM2441-3505... GW32-W	46
HM2441-3505... SPMK4	61
HM2441-3505... SPMK4-G	62
HM2441-3505... SPW32	47
HM2441-3505... SPW32-W	47
HO3000-3505... GMK4	61
HO3000-3505... GW32	47
HO3000-3505... SPMK4	62
HO3000-3505... SPW32	48
HQ3437-4780... GMK4	63-64
HQ3437-4780... GW40	49-50
HQ3437-4780... GW40-W	49
HQ3437-4780... SPMK4	63
HQ3437-4780... SPMK4-G	64
HQ3437-4780... SPW40	49
HQ3437-4780... SPW40-W	49
HS4699-6528... GMK5	65-66
HS4699-6528... GW40	50-51
HS4699-6528... GW40-W	50-51
HS4699-6528... SPMK5	65
HS4699-6528... SPW40	51
HS4699-6528... SPW40-W	51
HU6238-8908... GMK5	66-67
HU6238-8908... SPMK5	67
HW8776-11400... GMK5	68-69
HW8776-11400... SPMK5	68
L	
LPET... -ALU	181
LPET... -AWI	181
LPET... -WI	181
LPNT...	182

Bezeichnung Designation Désignation	Seite Page Pagina
P	
PA... (Ø9,5-Ø11)	75
PA... (Ø9,5-Ø11) -AS	75
PA... (Ø9,5-Ø11) -F	76
PC... (Ø11-Ø12,8)	76
PC... (Ø11,5-Ø12,8) -AS	77
PC... (Ø11,5-Ø12,8) -F	77
PE... (Ø13-Ø17,8)	78
PE... (Ø13-Ø17,5) -AS	79
PE... (Ø13-Ø17,5) -F	80
PI... (Ø17,5-Ø24,2)	81
PI... (Ø17,8-Ø24) -AS	82
PI... (Ø17,8-Ø24) -F	83
PM... (Ø24,5-Ø35)	84-85
PM... (Ø24,5-Ø35) -AS	86
PM... (Ø24,5-Ø35) -F	87
PQ... (Ø35-Ø47,6)	88
PQ... (Ø38-Ø45) -AS	89
PQ... (Ø36-Ø47) -F	89
PS... (Ø48-Ø65)	90
PS... (Ø60) -AS	91
PU... (Ø66-Ø89)	92
PW... (Ø90-Ø114)	93
S	
SC AD20... (Mini)	172
SC... G... (Standard) (1,5xD)	173
SC... SP... (Mini) (2,25xD)	172
SC... SP... (Mini) (4xD)	172
SC... SP... (Standard) (2,25xD)	174
SC... SP... (Standard Densimet) (3xD)	175
SCR... R02... (Rebore) (2,25xD)	176
SCR... R03... (Rebore) (2,25xD)	177
SD2... (Ø14-Ø32)	126
SD3... (Ø14-Ø32)	127
SD5... (Ø14-Ø32)	128
SD8... (Ø14-Ø31,5)	129
SDI...	132-133
SDI... -CI	134-135
SDI... -S	135
SDI... -VA	136-137
SPA... VHM/TiAIN (90°)	241
SPA... VHM/TiAIN (120°)	242
SPA... VHM/TiAIN (135°)	243
SPA... (90°) -PM HSS	244
SPA... (120°) -PM HSS	245
SPA... (135°) -PM HSS	246
SP... VHM/TiAIN (3xD)	208-209
SP... VHM/TiAIN (3xD) FK	206-207
SP... VHM/TiAIN (3xD) -PM HSS	216-217
SP... VHM/TiAIN (5xD)	218-219
SP... VHM/TiAIN (5xD) -H	226
SP... VHM/TiAIN (7xD)	228-229
SP... VHM/TiAIN (7xD) -PM HSS	230-231
SPC... VHM/TiAIN (3xD)	210-211
SPC... VHM/TiAIN (3xD) -ALU	212-213
SPC... VHM/TiAIN (3xD) -VA	214-215
SPC... VHM/TiAIN (5xD)	220-221
SPC... VHM/TiAIN (5xD) -ALU	222-223
SPC... VHM/TiAIN (5xD) -VA	224-225
SPC... VHM/TiAIN (8xD)	232-233
SPC... VHM/TiAIN (8xD) -ALU	234-235
SPC... VHM/TiAIN (8xD) -VA	236-237
SPC... VHM/TiAIN (10xD)	238
SPC... VHM/TiAIN (15xD)	239
SPC... VHM/TiAIN (20xD)	240
SPZ... VHM/TiAIN	247
SPZ... -PM HSS	248
X	
XDMT... -BS	158
XDMT... -BM	158
XDMT... -BR	159
XDMT... -BAL	159



HERAUSRAGEND. OUTSTANDING. ECCEZIONALE.

Kurz- oder Langdrehen, Stechen, Drehen, Bohren oder Fräsen: Was auch immer Sie vorhaben – es lohnt sich, bei ARNO vorbeizuschauen. Wir haben für fast jeden Anwendungsfall in der Zerspanung eine Lösung. Mit der richtigen Mischung aus Erfahrung, Pioniergeist und Qualität sorgen wir dafür, dass Sie mit passgenauen Werkzeugsystemen, Toolmanagement-Lösungen und cleveren Innovationen das Beste aus Ihrer Fertigung rausholen.

Turning or Swiss type turning, grooving, drilling or milling: whatever your requirements are, it's worth your while to take a look at ARNO. We have a solution for almost every metal-working application. We have the right mix of experience, pioneering spirit and quality to ensure that you get the best out of your production with the right tool systems, tool management solutions and clever innovations.

Tornitura o fantina mobile, scanalatura, foratura o fresatura: qualunque siano le vostre esigenze, vale la pena dare un'occhiata a ARNO. Abbiamo una soluzione per quasi tutte le applicazioni per la lavorazione dei metalli. Abbiamo il giusto mix di esperienza, spirito pionieristico e qualità per assicurarti di ottenere il meglio dalla tua produzione con gli utensili corretti, soluzioni di gestione degli utensili e innovazioni intelligenti.



Fordern Sie unsere weiteren Broschüren oder den Gesamtkatalog an.
For further information please ask for our complete catalogue.
Per ulteriori informazioni richiedete la raccolta cataloghi completa.

**Werkzeugsysteme zum Ein- und Abstechen, Drehen und Gewindedrehen,
Fräsen und Gewindefräsen, Bohren und zum Langdrehen.**

*Tool systems for parting and grooving, turning and threading,
milling and thread milling, drilling and for swiss type machining.*

Sistemi di utensili per trancature e scanalatura, tornitura e filettatura, fresatura
e filettatura di fresatura, foratura e tornitura o fantina mobile.

Karl-Heinz Arnold GmbH
Karlsbader Str. 4 | D-73760 Ostfildern
Tel +49 (0)711 34 802 0
Fax +49 (0)711 34 802 130

bestellung@arno.de
anfrage@arno.de
www.arno.de

ARNO (UK) Limited | Unit 9, 10 & 11, Sugnall Business Centre
Sugnall, Eccleshall | Staffordshire | ST21 6NF
Tel +44 01785 850 072 | Fax +44 01785 850 076
sales@arno.de | www.arno-tools.co.uk

ARNO Italia S.r.l | Via J. F. Kennedy 19 | 20871 Vimercate (MB)
Tel +39 039 68 52 101 | Fax +39 039 60 83 724
info@arno-italia.it | www.arno-italia.it

ARNO-Werkzeuge USA LLC | 1101 W. Diggins St.
US-60033 Harvard, Illinois
Tel +1 815 943 4426 | Fax +1 815 943 7156
info@arnousa.com | www.arnousa.com

ARNO RU Ltd. | Krassnaja Ul. 38 | RU-600015 Vladimir
Tel / Fax +7 4922 541125 | COT +7 4922 541135
info@arnoru.ru | www.arnoru.ru

ARNO Werkzeuge S.E.A. PTE. LTD. | 25 International Business Park
#04 – 70A German Center | SG-609916 Singapore
Tel +65 65130779 | Fax +65 68970042
info@arno.com.sg | www.arno.com.sg

AIF Cluses | 310 Rue des Îles | 74300 Cluses
Tél +33 (0)4 50 18 24 07 | Fax +33 (0)4 50 89 04 81
cluses@aif.fr

AIF – Ateliers de l'Île de France | 6 Rue des Entrepreneurs
CS30572 | 77272 Villeparisis Cedex
Tél +33 (0)1 64 27 03 30 | Fax +33 (0)1 64 27 03 49
info@aif.fr | www.aif.fr

AIF Sud | ZA des Massies | 2 Impasse du Bosquet
81800 Couffouleux
Tél +33 (0)5 63 33 60 42 | sud@aif.fr